

# MONITOR KEYBOARD

## User manual

**V1.5 version**

**PT3000**

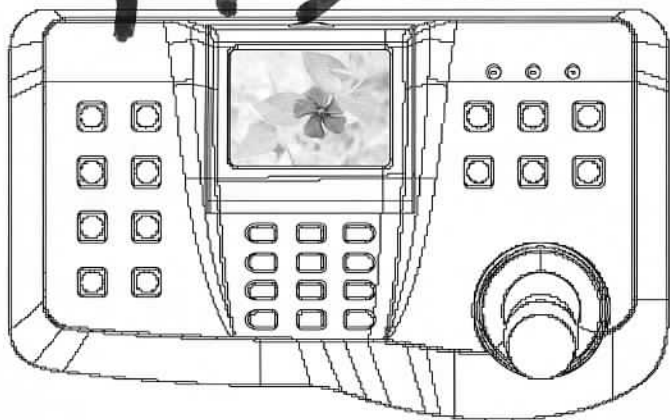

**DVR**

Please read the operation manual carefully  
before installing and using this unit

# INDEX

1.Important safeguards-----	1
2.General Install and connect-----	2
3.Install and connect-----	3~7
4.Description of Functions-----	8~10
5.Menu Setup-----	11~22
6.Appendix-----	22~26

### Note:

- Read the manual before install and use the keyboard.
- The product provide some same window information of Operation at not same protocol, if the product is not valid Function that it will display “**NONE VALID**” .
- The monitor keyboard used to DC12V power supply, check to the voltage and polarity of power-box before use the Monitor keyboard.
- Do not set the monitor keyboard to dank condition, prevent it to trouble.
- Do not open the product , prevent it to trouble.
- The keyboard have multi-protocol, right setup protocol, baud rate and ID address before use it, these parameters will display on screen.

## **General**

The monitor keyboard is a product which can control to demo camera and decoder. Used to EIA/RS-485 import between keyboard and demo camera. One keyboard can control 256 demo camera at best , the most communication distance is 2.4Km.end device can be set and Control easily with keyboard, Front device such as constant speed pan/tilt, lens, lamplight, water-brushcan be controlled also with keyboard by directly control decoder.

## **Install and connect**

Please read user manual of high speed dome camera carefully before connection. Device may be damaged forever with any error connection. Please shut off power before connection . use STP line to connect between device and device . Avoid from high voltage line or any possibly disturbed line as soon as possible when connecting cable.

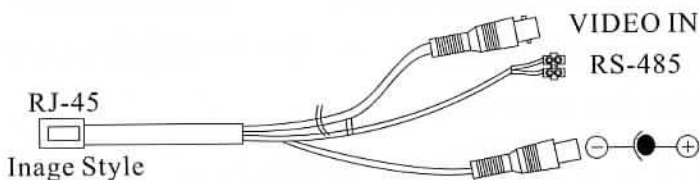
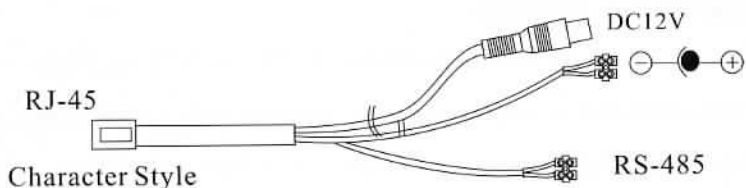
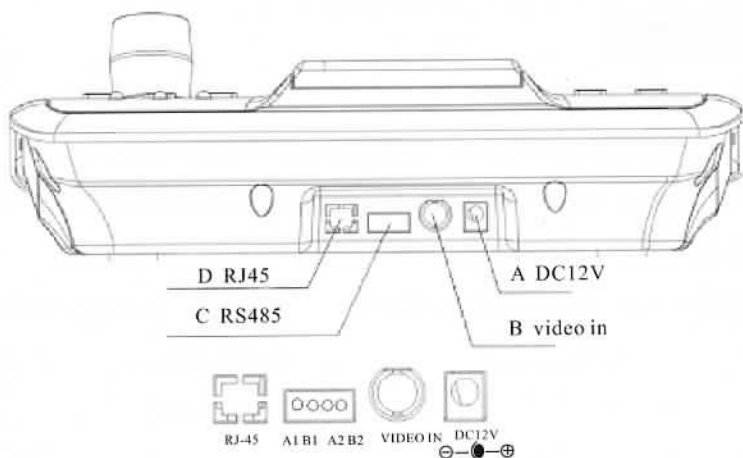

- Red: CH1 RS485+/A1
- Black: CH1 RS485-/B1
- Yellow: CH2 RS485+/A2
- Green: CH2 RS485-/B2

Figure 1

Figure 1 is the keyboard interface, include power in ,video in (used in 3.5inch LCD keyboard),RS485 communication interface and special interface.

- A. Power supply import: used to DC12V/1A
- B. Video import: 1V-pp
- C. RS485 communication import
- D. Rj45: system reserve
- E. Fence port is RS485 connection .If select special interface line which supply by engender, please refer to information of label to connect .

1.Keyboard connection:

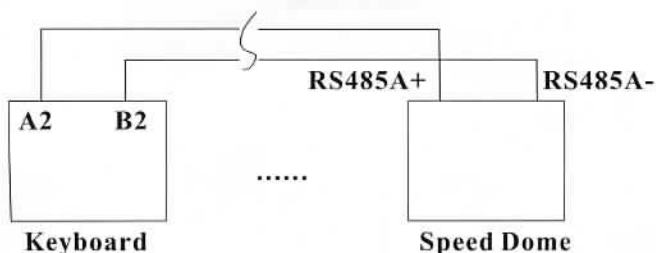

**Figure 2**

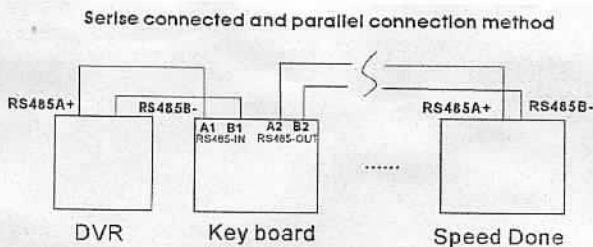

**Figure 3**

**NOTE:**

When DVD is occupies the Rs485 bus, according to Figure 3 the connection, When DVR dose not Occupies the RS485 bus, according to Figure 4 connection.

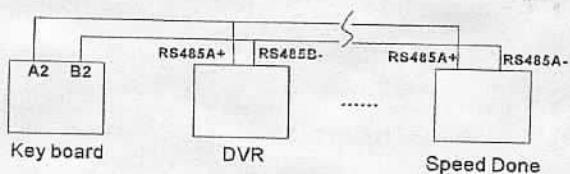

**Figure 4**

## 2. System connection:

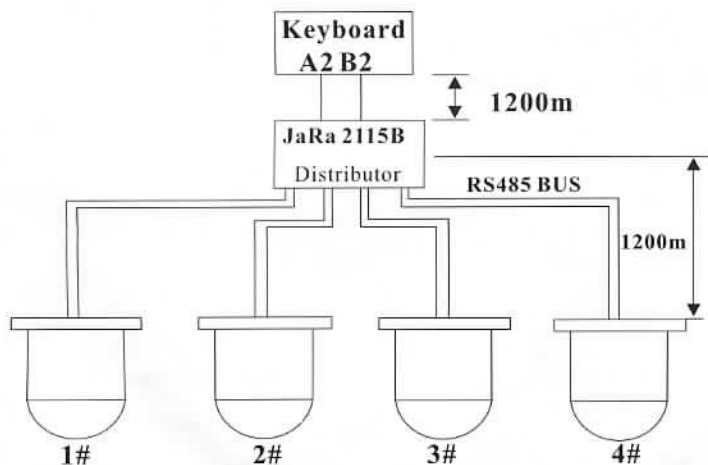

**Figure 5**

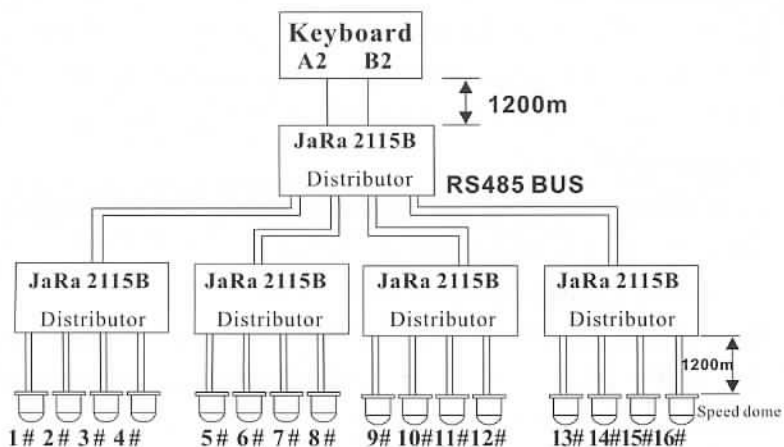

Figure 6

Picture Control Keyboard

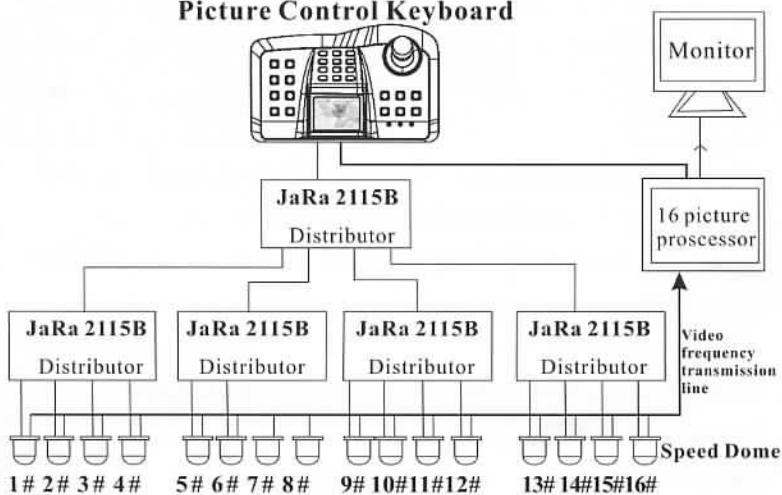

Figure 7



Explanation:

- 1、 The distributor can be in-line 3 tiers.
- 2、 Ordinary circumstances, 120  $\Omega$  of speed dome is in OFF state, If unable control, Then 120 OMEGA of speed dome ought to in ON state.

#### 4、 Transmission distances of RS485 Bus:

When user selects the 0.56mm (24AWG) twisted pair wires as data transmission cable, the maximum theoretical transmitting distances are as follows:

Baud Rate	Maximum Transmitting Distance
1200 Bps	2400m
2400 Bps	1800m
4800 Bps	1200m
9600 Bps	800m
19200 Bps	200m

Figure 7 is the connection of the two keyboard each. Picture Control Keyboard can work with the multivision plus processor, control it at long distance. and show image itself also. In connection diagram, the thick line is video line and the thin line is RS485 line. If use cable of connection, depend on label to connection cable. The communication mode between keyboard and demo speed camera: dot to multi-dot, semiduplex communication. Communication import: RS485.

Baud rate : 1200Bps,2400Bps,4800Bps,9600Bps, 19200Bps.

Communication distance:2.4km(Max)。

Power supply: DC12/1A。

Control number of demo camera: 256 (Max)。

**Function****Character Control Keyboard**

- Setup demo camera or decoder ID address range: 0~255.
- Control to multi-function of demo camera, such as: menu, focus, white balance.
- control the demo camera to multi-speed.
- Save preset position of demo camera, setup shot about the preset position. The keyboard can setup 8 shots, each shot can save 16 preset position.
- Two control mode: manual mode and auto mode.
- control zoom, focus and iris of demo camera by manual mode.

**Picture Control Keyboard**

- Picture Control Keyboard can show image, and the other functions are same as the Character Control Keyboard. It can work with multivision plus processor and control it at long distance.

**Panel introduce****1.front panel introduce (figure 3)**

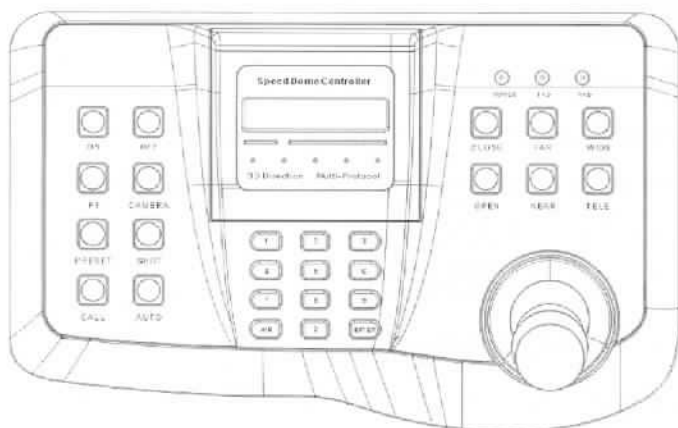

**Figure 8 Character control keyboard panel**

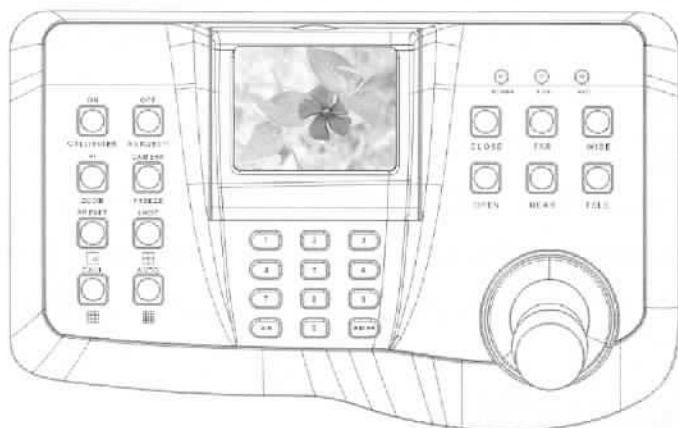

**figure 8-1 Image control keyboard panel**

Controls in front of the keyboard on to have the 3D speed change control rocking bar, the pressed key and the 16X2LCD display monitor, the display monitor uses in the display system condition and the operation information. pressed key explanation as follows:

**[ON]** open to function setup

**[OFF]** close to function setup

**[F1]** aux-keyboard

**[CAMERA]** setup demo camera ID address

**[PRESET]** save to preset position

**[SHOT]** call shot of demo camera

**[CALL]** call preset position

**[AUTO]** auto run demo camera

**[0]~[9]** number keyboard

**[A/B]** Swap key and clear number key

Swap key: swap general A key to Division plus processor B key, It is default general A key (type name on key ) after power on. Press the [A/B] key Transformation plus processor B key (type name below key). Press again the [A/B] key return to general A key.

**[ENTER]** enter keyboard

**[CLOSE]** reduce iris

**[FAR]** focus far

**[WIDE]** zoom out

**[OPEN]** increase iris

**[NEAR]** focus near

**[TELE]** zoom in

On the Picture control keyboard, the key operation of image processor please refer to the manual of the image processor.

## 2. Control keyboard support Protocol and baud rate.

## List1:Protocol list and baud rate list

Protocol	Baud rate(default)	protocol	Baud rate(default)
PELCO-D	2400	KALATEL	4800
PELCO-P	9600	VCLDOME	9600
PELCO-P	4800	REDAPPLE	9600
VIDO-BO1	9600	HTSCAM	9600
LILIN	9600	SAMSUNG	9600
ALEC	4800	SANTACHI450	9600
HD600	9600	SANTACHI650	9600
TOTA	4800	VICON	4800

NOTE: Press **F1 +61+ON**, **F1 +62+ON** to change protocol and baud rate, about content see List 2

## 3. Operation introduce

The keyboard controller must connected to demo camera and right setup ID address before operation. Then turn on power that it will display at bellow:

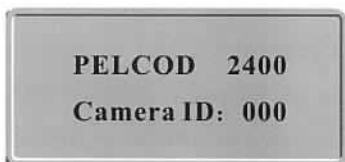

PELCO: current protocol

2400: current baud rate

000: current demo camera ID

## 3.1 Setup demo camera id address:

[CAMERA]+[N]+[ENTER]Display:

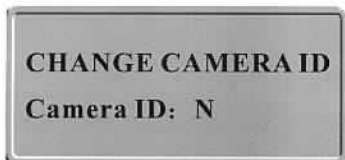

Note: N---ID address, range:0~255

Function: The choice treats the control the terminal address, when N value and ball machine address match the ball machine will accept the control, the following operates based on the terminal ID number will be 0 situations.

### 3.2 Aux-function setup

Enter menu of aux-function: **[F1] + [ON]** Display:



Note: press **[WIDE]** / **[TELE]** to select menu, press **[ENTER]** in to item.

Option such as change protocol ,change baud rate, change LCD back light (character) or expand monitor (image) and so on has be supplied at present .Expand monitor function is used when user need connect video with keyboard and connect it with monitor or image procession at the same time .When only connect with keyboard , select “ **CHANGE MONITORS**” ; when connect with monitor or other at the same time ,select “**CHANGE MONITORM**” .

Direct in to aux-function setup: **[F1] + [N] + [ON]**

Note 1: see List 2 about N value

Note 2: **[F1] + [61] + [ON]** for change protocol,  
**[F1] + [62] + [ON]** for baud rate

### 3.3 Save preset position: [PRESET]+[N]+[ENTER]

Display:

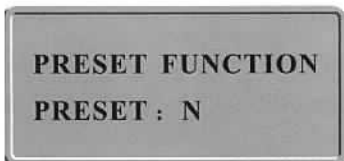

Note: N---position, range:1~255

Function:Stores up the current position, and supposes this position for the Nth position

### 3.4 Call preset position: [CALL]+[N]+[ENTER]

Display:

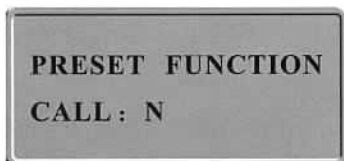

Note: N---the number of preset position, range:1~255

Function: Ball turning point to N initialization position

### 3.5 Clear preset position: [PRESET]+[N]+[OFF]

Display:

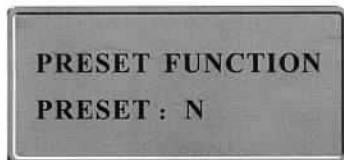

Note: N---preset position, range:1~255

Function: Will store up Nth initialization deletion

### 3.6 Setup shot of preset position

Note: the function is only used at VEDIO-B01

#### 3.6.1 Enter to item of setup shot :

[SHOT] + [N] + [ON] Display:

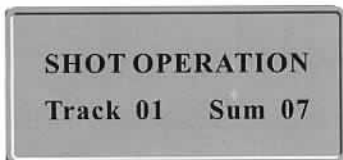

Note: the current setup is 1 shot, it contains 7 preset positions

#### 3.6.2 Edit shot:

press [ENTER] into status of editing shot, press [TELE] to ahead edit, press [WIDE] to backward edit. Each shot contain 16 preset positions and each a preset position can setup to speed or time of pause. Display:

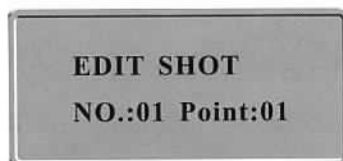

Note: select 01 preset position in first shot , The change preset position needs press [ENTER] to confirm and enter the next setup.

Display:

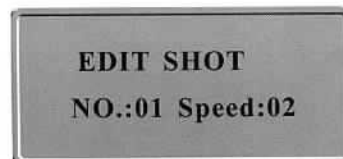

Note: select 2 stopspeed in 01 preset , The change preset position needs press [ENTER] to confirm and enter the next setup.



Display:



Note: select 3 seconds for pause time of 01 preset position, The change pause time needs press [ENTER] to confirm and enters the next setup.

**Note:**

- 1). Speed range: 1~8, the first step speed is the most slow, the eighth step speed is most flash speed. The speed will be defaulted 1 step if speed range is over. Pause time range: 1~255.
- 2). If the preset position, speed and pause time is not defined that these parameter is defined to 0.
- 3). Press OFF key to exit when finishing the shot setup, the parameter will be not saved if you are operation to joystick while setup the parameter.
- 4). Some high speed dome camera can set track on menu , detailed operation look at user manual of high speed dome camera

3.7 Run shot: **[SHOT]+[N]+[ENTER]** Display:



Note: N — — — number of shot , range: 0~8

Function: Moves the Nth path, the shot mode will be stop when operation joystick.

3.8 Stop to shot mode: **[SHOT]+[OFF]**

Function: stop the state of shot running, the shot mode will be stop when operation joystick.

3.9 Run the state of plane scan: **[AUTO]+[ON]**

Display:



Function: run the state of plane scan for 360° monitor.

3.10 Top the state of plane scan: **[AUTO]+[OFF]**

Function: run the state of plane scan for 360° monitor.

3.11 Control camera to zoom: **[WIDE] / [TELE]**

3.12 Control camera to focus: **[FAR] / [NEAR]**

3.13 Control camera to iris: **[OPEN] / [CLOSE]**

## List2 Aux-function about+N+ENTER

N Number	controlitem	define	
		[F1]+N+[ON]	[F1]+N+[OFF]
0	Camera power supply	Turn on	Turn off
1	Backlight compensate	ON	OFF
2	Zero illumination	ON	OFF
3	menu	ON	OFF
4	Digital zoom	ON	OFF
5	Camera reset	Returns to the level which was set by the manufacturer for shipment	
6	focus	Auto	manual
7	iris	Auto	manual
8	White balance	Auto	manual
9		indoor	outdoor
10		ATW	One Push WB
11	Color/black-white	Color	white
12	Speed of line scan direction of line scan	Less than 180° low speed	more than 180° low speed
13		Less than 180° mid speed	more than 180° mid speed
14		Less than 180° high speed	more than 180° high speed
15	Keyboard backlight	ON	OFF
61	Change protocol	Enable the function	disable the function
62	Change baud rate	Enable the function	disable the function

Note: 1 to 15 function is only used at **VEDIO-B01**

Notice: what introduce is some common operation function, but not all protocol and end device have this ,such camera that not supply night /day can not switch between black and color .Operation that protocol not supply will show “NONE VALID” .

Below is the LILIN Protocol establishment

1、 Setup preset position:

a) Press **[CALL]+[N]+[ENTER]** Display:

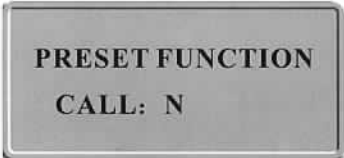

**PRESET FUNCTION**  
**CALL: N**

Note: N---position, range:0~255

Is the speed dome run to set up before the preset position, if not previously set up, every time in a specific location. Operation joystick to the need place.

b)Save pause time: press **[PRESET]+[N]+ [ENTER]**

Display:

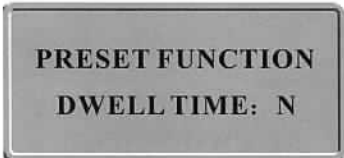

**PRESET FUNCTION**  
**DWELL TIME: N**

Note: N---pause time, range 0~255

c)Save step speed in preset position: Save pause time and press **[ENTER]** Display:



**PRESET FUNCTION**  
**RUN SPEED : N**

Note: N--- step speed, range: 1~255(1:low speed, 255:high speed)

d) Save step speed in preset position, press [N]+[ENTER].

2、 Call preset position: [CALL]+[N]+[ENTER]

3、 Clear all preset position: [PRESET]+[255]+[ENTER]+[255]+[OFF]

a) Press [PRESET]+[255] Display:

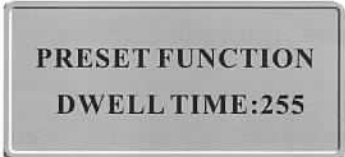

PRESET FUNCTION  
DWELL TIME:255

b) Press [ENTER]+[255] Display:

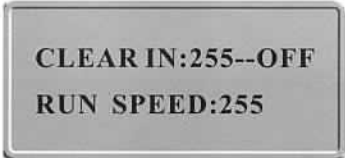

CLEAR IN:255--OFF  
RUN SPEED:255

Note: input **255**, press [OFF] It will clear all preset position.

4. Setup alarm: [AUTO]+[ON]+[N]+ [ENTER]

a) Press [AUTO] Display:



SPECIAL FUNCTION  
AUTO:

b) Press [ON]+[N] Display:



Note: N---PIN's input, range: 0~255

(Actual could not use to be 255)

The key completes PIN after [ ENTER ] the establishment

5、 Clear setup alarm: [AUTO]+[OFF]

6、 Run shot: [SHOT]+[N]+ [ENTER]

Display:

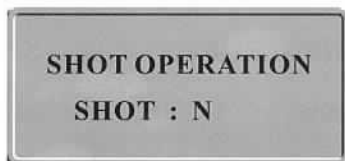

Note:

1) N=000 sets up 1, 2,3,4 group group and runs 1~16 preset position,

2) N=001 set up 1 group group and run 1~4 preset position,

3) N=012 sets up 1, 2 group group and runs 1~8 preset position,.....

4) N=234 sets up 2,3,4 group group and runs 5~16 preset position

Commonly :

First group group comprises 1,2,3,4 preset position

Second group group comprises 5,6,7,8 preset position

Third group group comprises 9,10,11,12 preset position

Fourth group group comprises 13,14,15,16 preset position

If differ, please refer to “**speed dome user manual**” .

7、 1) Setup menu: [CALL]+[95]+ [ENTER]

7、 2) Clear menu: press [CALL]+[95]+ [ENTER] again.

Speed change joystick control the DEMO following chart: The use speed change rocking bar may control the camera at will electrically operated the DEMO revolves/dealswith the direction speed. Through the change joystick angle of tilt size which revolves the speed which/deals with is which the basis shows the operation rocking bar angle determined may in the step less control rotational speed rotation scanning process, the camera opportunity automatic focusing maintenance picture be clear.

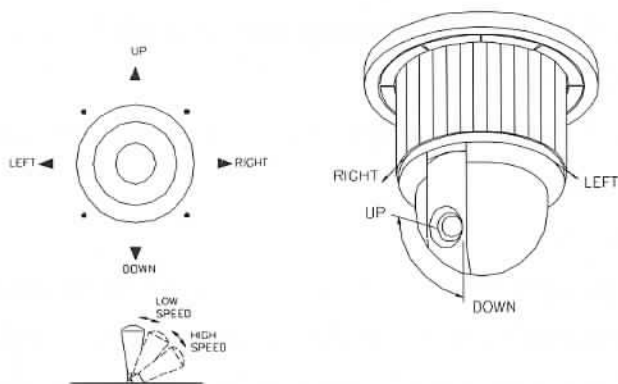

Picture Control Keyboard can show image, and other functions are same as the Character Control Keyboard. It can work with multivision plus processor and control it at long distance.

Press the key A/B once to switch to image processor mode to normal mode. on image processor mode, showing as bellow:

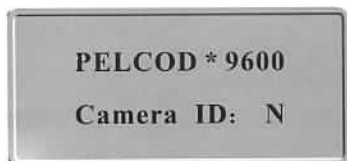

Display “\*” between protocol and baud rate. Press A/B again to cancel image processor mode. On image processor mode:

Press **[ENTER]+0+[ENTER]**, into image processor functional menu.

Press **[ENTER]+N+[ENTER]**, into the N input video, N=1-16  
With **[CALL/ENTER]**, **[AUTO/EXIT]**, **[ZOOM]**, **[FREEZE]**,  
**[one image]** key ,**[four image]** KEY, **[nine image]** KEY and  
**[sixteen image]** key, other operation can be done. The key  
function is same as image processor panel. The function and  
the operation refer to manual of image processor.



## Specification list

Screen display	16x2 character	3.5"LCD color picture
Control object	High speed ball , general ballPTZ decode	High speed ball ,general ball PTZdecode,16picture processor
Protocol	PELCO-D , PELCO-P	
	ALEC , SAMSUNG	
	VIDO-B01 , NEON	
	HTSCAM	
	HD600 , TOTA	
	KALATEL , VCLDOME	
	REDAPPLE ,SANTACHI450	
	SANTACHI650 ,VICON	
Baud rate	1200bps,2400bps,4800bps,9600bps,19200bps	
Out channel	2 channel	
Communication distance	Max :2400m	
Operation Temperature	-10℃-50℃	
Power	DC12V/1A	DC12V/1A

## 1. Lighting proof and surge signal proof

The product adopts TVS lightning proof technology to prevent from damage by lightning strike below 1500 W and impulse signals such as surge; but it is also necessary to abide by the following precautions to ensure electrical safety based on practical circumstances:

- Keep the communication cables at least 50 meters away from high voltage equipment or cables.
- Make outdoor cable laying-out under eaves as possible as you can.
- In open area shield cables in steel tube and conduct a single Point ground to the tube. Trolley wire is forbidden in such circumstances.
- In strong thunderstorm or high far adic zone (such as high voltage transformer substation), extra strong lightning proof equipment must be installed.
- Take the building lightning proof requirements into account to design the lightning proof and grounding of outdoor equipment and cable laying-out in accordance with the national and industrial standards.
- The system must be grounded with equal potentials. The earth ground connection must satisfy the anti-interference and electrical safety requirements and must not short circuited with high voltage electricity net. When the system is grounded separately, the resistance of down conductor should be  $\leq 4 \Omega$  and the sectional area of down conductor should be  $\leq 25 \text{mm}^2$ .

## 2. RS485 bus basic knowledge

### 1) Characteristics of RS485 Bus

As specified by RS485 standards, RS485 Bus is of half-duplexed data transmission cables with characteristic impedance as  $120\ \Omega$ . The maximum load capacity is 256 nit loads (including main controller and controlled equipment).

### 2.) Transmission distances of RS485 Bus

When user selects the 0.56mm (24AWG) twisted pair wires as data transmission cable, the maximum theoretical transmitting distances are as follows:

Baud Rate	Maximum Transmitting Distance
1200 Bps	2400m
2400 Bps	1800m
4800 Bps	1200m
9600 Bps	800m
19200 Bps	200m

### 3) connection and termination resistor

a) The RS485 standards require a daisy-chain connection between the equipment. There must be termination resistors with  $120\ \Omega$  impedance at both ends of the connection. (refer to Figure 1). Please refer to Picture 2 for simple connection. "D" should exceed 7m.

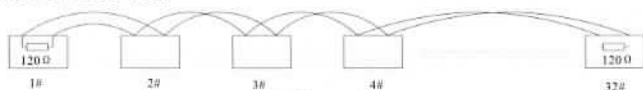

Figure 1

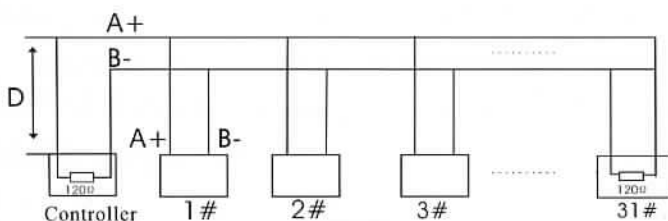

Figure 2

b) The connection of  $120\ \Omega$  termination resistor: See to single system connection.

4) In some circumstances user adopts a star configuration in practical connection. The termination resistors must be connected to the two equipment that are farthest away from each other, such as equipment 1# and 15# in figure3. As the star configuration is not in conformity with the requirements of Rs485 standards, problems such as signal reflections, lower anti-interference performance arise when the cables are long in the connection. The reliability of control signals is decreased with the phenomena that the dome does not respond to or just responds at intervals to the controller, or does continuous operation without stop (refer to figure4)

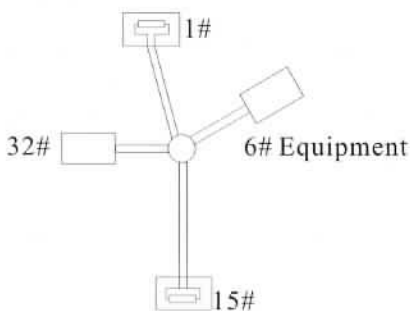

Figure3

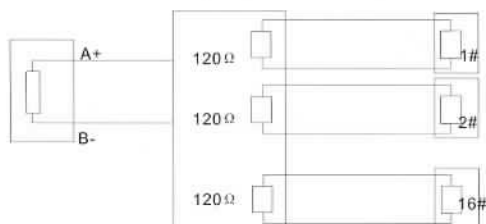

Figure4