

---

# NETWORK VIDEO RECORDER USER GUIDE

VER HD4K-1.0(A01)



- Thank you for purchasing this HD IP Network Video Recorder.
- Before using the IP Network Video Recorder, please ensure that you read and understand the User Guide.
- Please store the User Guide at an easily accessible location.
- Before connecting and installing any third party IP cameras, monitors, alarms and computers, please refer to the appropriate instruction manual for proper operation.

## SAFETY PRECAUTIONS



### CAUTION:

TO REDUCE THE RISK OF ELECTRIC SHOCK, DO NOT REMOVE COVER (OR BACK).  
NO USER SERVICEABLE PARTS INSIDE. REFER SERVICING TO QUALIFIED  
SERVICE PERSONNEL.



The lightning flash with arrowhead symbol, within an equilateral triangle, is intended to alert the user to the presence of an insulated “dangerous voltage” within the product’s enclosure that may be of sufficient magnitude to constitute a risk of electric shock to persons.



The exclamation point within an equilateral triangle is intended to alert the user to the presence of important operating and maintenance (servicing) instructions in the literature accompanying the appliance.

### WARNING:

TO PREVENT FIRE OR ELECTRIC SHOCK HAZARD,  
DO NOT EXPOSE THIS APPLIANCE TO RAIN OR MOISTURE.

---

# Contents

<b>Disclaimer</b> .....	5
<b>Warning</b> .....	5
<b>Caution</b> .....	6
<b>Preventing Malfunction</b> .....	7
<b>Regulatory</b> .....	7
<b>Package Contents</b> .....	9
<b>I.CONTROLS</b> .....	10
1. Front Panel.....	10
2. Rear Panel Connectors .....	11
3. Remote Controller .....	13
4. Mouse Control .....	15
5. Virtual Keyboard for Mouse Control .....	15
<b>III.QUICK START PAGE</b> .....	16
<b>IV.LIVE VIEWING</b> .....	19
1. Display Overview .....	19
2. Multi-screen Display and Sequencing .....	21
2.1. Screen Display. ....	21
2.2. Multi-screen Display and Switch Sequencing Display.....	21
3. Quick button for multi screen Display. ....	22
3.1. Quick multi split mode change.....	22
3.2. Repositioning .....	22
4. Zooming .....	23
<b>V. OPERATION</b> .....	24
1. LOG IN/OUT.....	24
2. NAVIGATION THE MENU .....	25
<b>VI. SETUP</b> .....	26
1. DISPLAY .....	26
1.1. GENERAL .....	26
1.2. SWITCH Setup (Monitor Configure) .....	27
1.3. EVENT .....	28
2. CAMERA.....	29
3. RECORD .....	33
3.1. Record General .....	33
3.2. Continues /Normal Recording .....	34
3.4.1 Alarm Recording .....	35

---

3.4.2	Motion Recording .....	36
3.4.3	Multi Event Recording .....	36
<b>3.5</b>	<b>Continuous + Event (Motion/Alarm) Recording</b> .....	<b>37</b>
<b>4.</b>	<b>SCHEDULE</b> .....	<b>38</b>
4.1.	CHART Setup .....	38
4.2.	Holiday Setup .....	40
<b>5.</b>	<b>DISK</b> .....	<b>41</b>
5.1.	DISK Manager .....	41
5.2.	Recording DISK .....	43
5.3.	S.M.A.R.T STATUS .....	44
<b>6.</b>	<b>NETWORK</b> .....	<b>45</b>
6.1.	LAN Port & IPCAM Port .....	45
<b>6.2.</b>	<b>GENERAL</b> .....	<b>46</b>
<b>6.3.</b>	<b>EMAIL</b> .....	<b>57</b>
<b>6.4.</b>	<b>SMTP</b> .....	<b>58</b>
<b>6.5.</b>	<b>DDNS (Dynamic DNS)</b> .....	<b>59</b>
<b>6.6</b>	<b>Router &amp; Port Forwarding</b> .....	<b>61</b>
<b>7.</b>	<b>DEVICE</b> .....	<b>62</b>
<b>7.1.</b>	<b>GENERAL</b> .....	<b>63</b>
I/O	Terminal.....	64
<b>7.3.</b>	<b>PTZ EVENT</b> .....	<b>67</b>
<b>8.</b>	<b>SYSTEM</b> .....	<b>68</b>
<b>8.1.</b>	<b>GENERAL</b> .....	<b>68</b>
<b>8.2.</b>	<b>TIME</b> .....	<b>69</b>
<b>8.3.</b>	<b>ACCOUNT</b> .....	<b>70</b>
<b>8.4.</b>	<b>UPDATE</b> .....	<b>72</b>
<b>8.5.</b>	<b>INFO</b> .....	<b>73</b>
<b>VII.</b>	<b>PAN/TILT ZOOM CONTROL</b> .....	<b>74</b>
<b>1.</b>	<b>P.T.Z. Menu</b> .....	<b>74</b>
<b>2.</b>	<b>Preset &amp; Tour</b> .....	<b>76</b>
<b>3.</b>	<b>Custom Functions</b> .....	<b>77</b>
<b>4.</b>	<b>Auto Pan / Auto Tilt / Power</b> .....	<b>77</b>
<b>VIII.</b>	<b>PLAYBACK /SEARCH</b> .....	<b>78</b>
<b>1.</b>	<b>Playback</b> .....	<b>78</b>
<b>2.</b>	<b>Time Search</b> .....	<b>78</b>
<b>3.</b>	<b>Go to Search</b> .....	<b>83</b>
<b>4.</b>	<b>Log List Search</b> .....	<b>84</b>

---

**IX.BACKUP ..... 85**

- 1. Manual Back Up ..... 85**
- 2. Auto Back Up (FTP) ..... 88**
- 3. Log List Back Up ..... 89**

**X.CLIENT ..... 90**

**XI.SPECIFICATION ..... 91**

---

## Disclaimer

- The information in this manual is believed to be accurate and reliable as of the date of publication. The information contained herein is subject to change without notice. Revisions or New editions to this publication may be issued to incorporate such change
- We makes no warranties for damages resulting from corrupted or lost data due to a mistaken operation or malfunction of the Network Video Recorder, the software, the hard drives, personal computers, peripheral devices, or unapproved/unsupported devices.

## Warning

- Do not cover the ventilation opening or slots on the outer casing. To prevent the appliance from overheating, provide at least two inches of air space around the vent and the slots.
- Do not drop metallic parts through slots. This could permanently damage the Digital Video Recorder. Immediately turn the NVR's power off or unplug the power cord from the power outlet. Contact a qualified service personnel authorized by your equipment distributor
- Do not attempt to disassemble or alter any part of the equipment that is not expressly described in this guide. Disassembly or alteration may result in high voltage electrical shock. Qualified service personnel authorized by your equipment distributor should conduct internal inspections, alterations and repairs.
- Stop operating the equipment immediately if it emits smoke or noxious fumes. Failure to do so may result in fire or electrical shock. Immediately turn the NVR's power off, remove the power cable from the power outlet. Confirm that smoke and fume emissions have ceased. Please consult your NVR distributor.
- Stop operating the equipment if a heavy object is dropped or the casing is damaged. Do not strike or shake. Failure to do so may result in fire or electrical shock. Immediately turn the NVR's power off or unplug the power cord from the power outlet. Please consult your NVR distributor.
- Do not allow the equipment come into contact with, or become immersed in, water or other liquids. Do not allow liquids to OK the interior. The NVR has not been waterproofed. If the exterior comes into contact with liquids or salt air, wipe it dry with a soft, absorbent cloth. In the event that the water or other foreign substances OK the interior, immediately turn the NVR's Power off or unplug the power cord from the power outlet. Continued use of the equipment may result in fire or electrical shock. Please consult your NVR distributor.
- Do not use substances containing alcohol, benzene, thinners or other flammable substances to clean or maintain the equipment. The use of these substances may lead to fire. Use a

---

dry cloth on a regular periodic basis and wipe away the dust and dirt that collects on the device. In dusty, humid or greasy environments, the dust that collects around the ventilation or the slots on the outer casing over long periods of time may become saturated with humidity and short-circuit, leading to fire.

- Do not cut, damage, alter or place heavy items on the power cord. Any of these actions may cause an electrical short circuit, which may lead to fire or electrical shock.
- Do not handle the device or power cord if your hands are wet. Handling it with wet hands may lead to electrical shock. When unplugging the cord, ensure that you hold the solid portion of the plug. Pulling on the flexible portion of the cord may damage or expose the wire and insulation, creating the potential for fires or electrical shocks.
- Use only the recommended power accessories. Use of power sources not expressly recommended for this equipment may lead to overheating, distortion of the equipment, fire, electrical shock or other hazards.
- Do not place the batteries near a heat source or expose them to direct flame or heat. Neither should you immerse them in water. Such exposure may damage the batteries and lead to the leakage of corrosive liquids, fire, electrical shock, explosion or serious injury.
- Do not attempt to disassemble, alter or apply heat to the batteries. There is serious risk of injury due to an explosion. Immediately flush with water any area of the body, including the eyes and mouth, or clothing that comes into contact with the inner contents of the battery. If the eyes or mouth contact these substances, immediately flush with water and seek medical assistance from a medical professional.
- Avoid dropping or subjecting the batteries to severe impacts that could damage the casings. It could lead to leakage and injury.
- Do not short-circuit the battery terminals with metallic objects, such as key holders. It could lead to overheating, burns and other injuries.
- The supplied power supply and power cord are designed for exclusive use with the Digital Video Recorder. Do not use it with other products or batteries. There is a risk of fire and other hazards.

## Caution

- Do not operate the appliance beyond its specified temperature, humidity or power source ratings. Do not use the appliance in an extreme environment where there is high temperature or high humidity. Use the device at temperatures within +0°C - +40°C (32°F - 104°F) and humidity below 90 %. The normal operating power source for this device is 100V-240V AC 50/60Hz.

---

## Preventing Malfunction

- Avoid Strong Magnetic Fields. Never place the NVR in close Proximity to electric motors or other equipment generating strong electromagnetic fields. Exposures to strong magnetic fields may cause malfunctions or corrupt image data.
- Avoid Condensation Related Problems. Moving the equipment rapidly between hot and cold temperatures may cause condensation (water droplets) to form on its external and internal surfaces. You can avoid this by placing the equipment in an airtight, resalable plastic bag and letting it adjust to temperature changes slowly before removing it from the bag.
- If Condensation forms inside the Digital Video Recorder. Stop using the equipment immediately if you detect condensation. Continued use may damage the equipment. Remove the power cord from the power outlet and wait until the moisture evaporates completely before resuming use.

## Regulatory

**FCC Compliance** : This equipment has been tested and found to comply with the limits for a Class A digital device, pursuant to part 15 of the FCC Rules. These limits are designed to provide reasonable protection against harmful interference when the equipment is operated in a commercial environment. This equipment generates, uses, and can radiate radio frequency energy and, if no installed and used in accordance with the instruction manual, may cause harmful interference to radio communications. Operation of this equipment in a residential area is likely to cause harmful interference in which case the user will be required to correct the interference at his own expense.

### Description on Laser Specification

The optical disc drive such as DVD Super Multi (Double Layer) Drive 22X that is used in this computer is equipped with laser. The classification label with the following sentence is affixed to the surface of the drive.

**CLASS 1 LASER PRODUCT TO IEC60825-1 LASER KLASSE 1** The drive with the above label is certified by the manufacturer that the drive complies with the requirement for laser product on the date of manufacturing pursuant to article 21 of Code of Federal Regulations by the United States of America, Department of Health & Human Services, Food and Drug Administration. In other countries, the drive is certified to comply with the requirement pursuant to IEC 60825-1 and EN 60825-1 on class 1 laser product. This computer is equipped with the optical disc drive in the following list according to the model.

### EU Conformity Statement:





**2002/96/EC (WEEE Directive)** : Products marked with this symbol cannot be disposed of as unsorted municipal waste in the European Union. For proper recycling, return this product to your local supplier upon the purchase of equivalent new equipment, or dispose of it at designated collection points. For more information, see: [www.recyclethis.info](http://www.recyclethis.info).



**2006/66/EC (Battery Directive)** : Products marked with this symbol cannot be disposed of as unsorted municipal waste in the European Union. For proper recycling, return this product to your local supplier upon the purchase of equivalent new equipment, or dispose of it at designated collection points. For more information, see: [www.recyclethis.info](http://www.recyclethis.info).

**NOTE:** THE MANUFACTURER IS NOT RESPONSIBLE FOR ANY RADIO OR TV INTERFERENCE CAUSED BY UNAUTHORIZED MODIFICATIONS TO THIS EQUIPMENT. SUCH MODIFICATIONS COULD VOID THE USER'S AUTHORITY TO OPERATE THE EQUIPMENT.

**CAUTION**

- Risk of Explosion if Battery is replaced by an Incorrect Type. Dispose of Used Batteries according to the Instructions.
- The socket-outlet shall be installed near the equipment and shall be easily accessible

---

# Package Contents

Please check the package and contents for visible damage. If any components are damaged or missing, do not attempt to use the unit, contact the supplier immediately. If the unit must be returned, it must be shipped in the original packing box.

<b>CONTENTS</b>	<b>QUANTITY</b>	<b>REMARK</b>
NVR SET	1 UNIT	
MOUSE	1	
REMOTE CONTROL	1	
BATTERY (AAA size)	2	
ADAPTER (12V/5A)	1	For NVR SET
ADAPTER (48V/1A or 48V/2A)	1	For PoE Power
POWER CORD	2	
HDD BRACKET	4	To install HDDs
HDD CABLE	2	
CLIENT SOFTWARE CD	1	Manual included

---

# I.CONTROLS

## 1. Front Panel



1) **Mode Indicator:** 4 LEDs display the status of the Network Video Recorder.

- PWR : Power ON / OFF status
- HDD : Blinking if Recording in the HDD or Playback
- NET : Network connection
- STATUS : Responding with Buzzer

2) **USB**  : USB compliant port allows use of memory stick to backup video files or SW upgrade and Mouse.

## 2. Rear Panel Connectors

### 4ch PoE

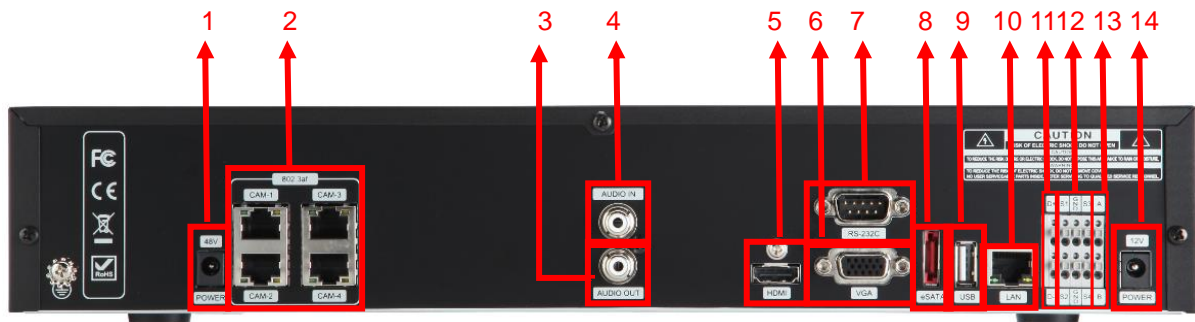

### 8ch PoE

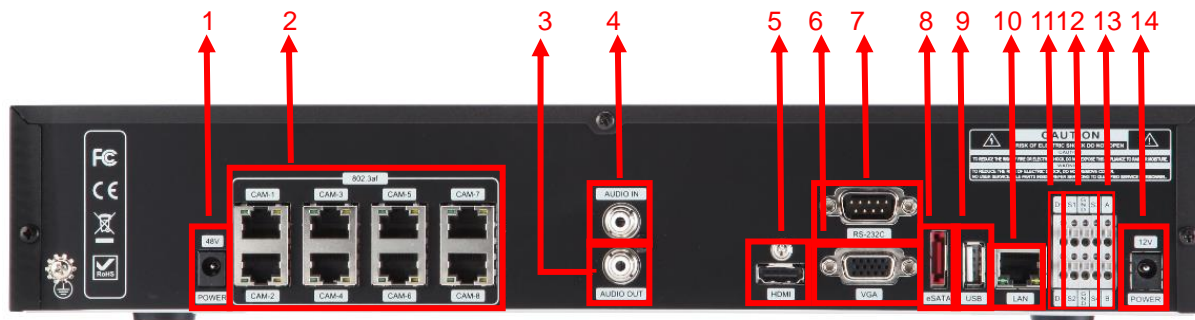

### W/O PoE

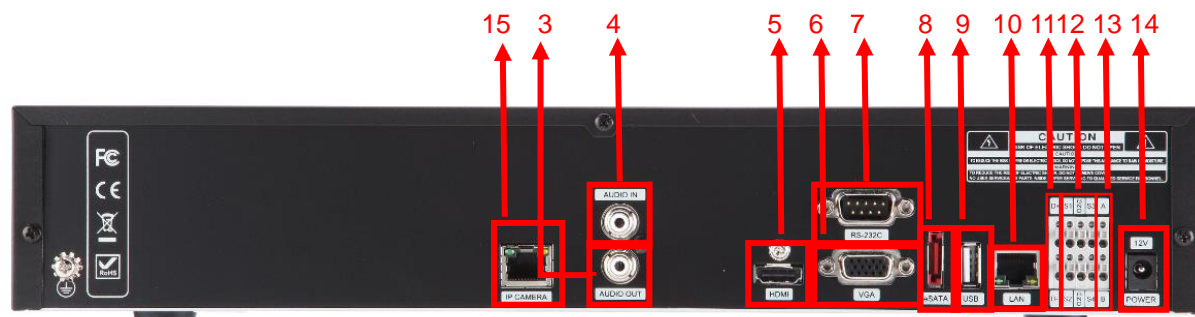

- 
- 1) **POWER(48V)** : DC power Jack (PoE model only)
  - 2) **IP PoE Camera input** : RJ45 input connectors (PoE model only)
  - 3) **AUDIO Output connector**: RCA port(mono) for audio output.
  - 4) **AUDIO Input connector**: RCA port(mono) for audio input.
  - 5) **HDMI out connector**: Used as the main video output.
  - 6) **VGA out connector**: Used as the main video output
  - 7) **RS-232C [D-SUB 9PIN]**: For connecting to Debugging.
  - 8) **e-SATA connector**: For connecting e-SATA compatible devices.
  - 9) **USB 2.0 connector**: For connecting USB compatible devices.
  - 10) **LAN Port**: For connecting to remote PC via Ethernet network. **10/100/1000 BASE-T**
  - 11) **RS485** : To connect and control PTZ IP Cameras
  - 12) **Alarm Input** : To connect Alarm input device
  - 13) **Alarm Output** : To connect the Alarm output device
  - 14) **POWER(12V)** : DC power Jack for NVR unit
  - 15) **IP Camera Port** : IP Camera input (None PoE model only)

### 3. Remote Controller

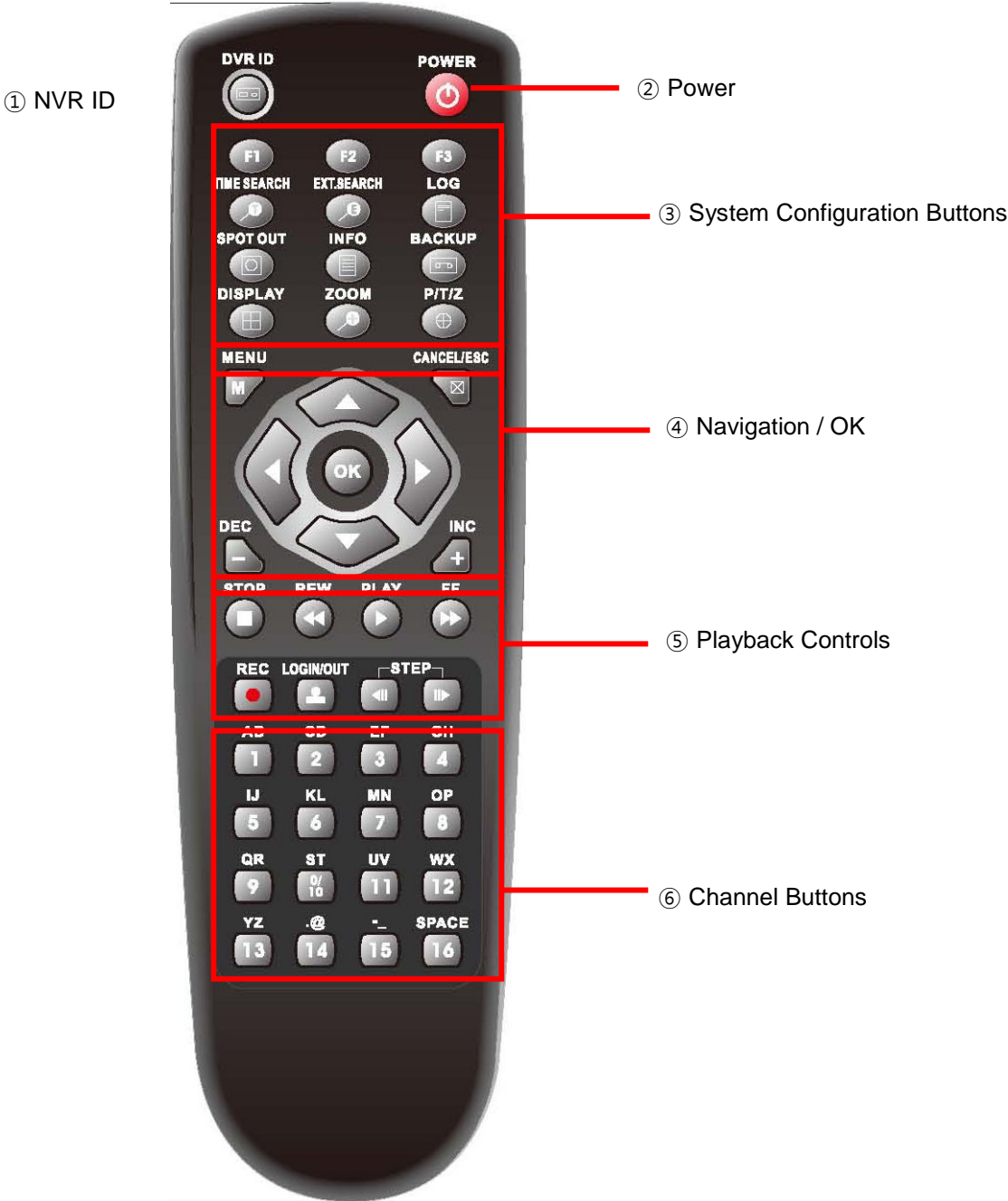

**NVR ID:** Set the proper NVR System ID through which to operate. Press the ID button, and then press the number button within two seconds to select the system ID of the NVR. If you set the System ID to Zero, you can control multiple NVRs at the same time.

## - Letters in Device

Allows you to create a unique name for each camera and put figures in set up menu.

User can use the virtual keyboard or press the appropriate numeric button on the IR Remote or the front panel.

No	1st	2nd	3rd	4th	5th	6th	7th	8th
1	a	b	c	1	A	B	C	1
2	d	e	f	2	D	E	F	2
3	g	h	i	3	G	H	I	3
4	j	k	l	4	J	K	L	4
5	m	n	o	5	M	N	O	5
6	p	q	r	6	P	Q	R	6
7	s	t	u	7	S	T	U	7
8	v	w	x	8	V	W	X	8
9	y	z	@	9	Y	Z	@	9
10/0	.	-	_	0	.	-	_	0

<on Front Panel >

No	1st	2nd	3rd	4th	5th	6th
1	a	b	1	A	B	1
2	c	d	2	C	D	2
3	e	f	3	E	F	3
4	g	h	4	G	H	4
5	i	j	5	I	J	5
6	k	l	6	K	L	6
7	m	n	7	M	N	7
8	o	p	8	O	P	8
9	q	r	9	Q	R	9
10/0	s	t	0	S	T	10
11	u	v	U	V		
12	w	X	W	X		
13	y	z	Y	Z		
14	.	@	.	@		
15	-	_	-	_		
16	space					

<On IR Remote Controller >

---

## 4. Mouse Control

This IP NVR can be controlled by the mouse. Connect the mouse to the USB port before use.

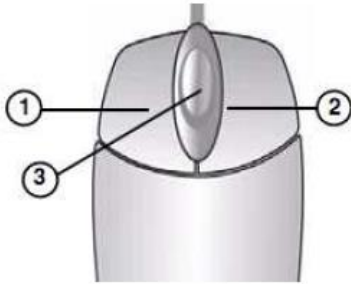

1) **Left-Button** -Double Click on any channel to enlarge to full screen while in a split-screen display mode and double click again to return.

Select the menu option while navigating through various menu options.

2) **Right Button**- Right click anywhere on the screen to open main menu. Double click to return.

3) **Scroll Wheel**: move the scroll wheel up or down to increase/decrease the value of the selected menu option.

## 5. Virtual Keyboard for Mouse Control

This system provides a virtual on-screen keyboard to perform the control by mouse. Connect a mouse via USB port before use.

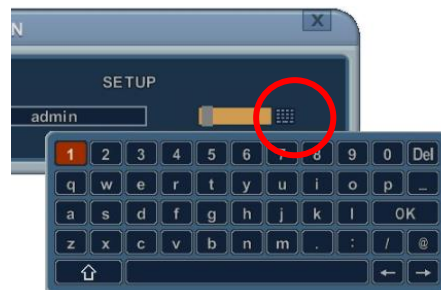

<Virtual Keyboard>



---

# III. QUICK START PAGE



"admin "and the default password is "000000"



The Default User ID "admin" and password to run the EMS 2.0 software is "0"

Main Menu



---

## Time & Date Setting

When the NVR is powered on for the very first time, the time and date are set as default to January 1, 2009 Thursday 01:00:00. Before any other operation of the Network Video Recorder, it is important to setup the time and the date. Please refer for setting the time and the date on the NVR.



**SYSTEM**

**GENERAL** **TIME** ACCOUNT UPDATE

TIME ZONE	GMT+00:00 (STANDARD)
DATE FORMAT	MM/DD/YYYY
NTP SYNC	<input checked="" type="radio"/> ON <input type="radio"/> OFF
NTP SERVER	
NTP TEST	START
DATE	MM/DD/YYYY (MM/DD/YYYY)
TIME	hh:mm:ss (HH:MM:SS)

SAVE

# IV.LIVE VIEWING

## 1. Display Overview



### 1. Recording Mode 1 2 4

Background color of Number will be different based on the recording status.

- 1) Red - Event (Motion/Alarm) Recording
- 2) Yellow - Continuous Recording
- 3) Black - No Recording.

(1) (2) (3)

### 2. Event Indicator 1 2 3

(1) Indicate **Alarm** In terminal is triggered by an alarm sensor.



To appear Alarm window, press **[UP]** button. This button toggles between Shows or Hide the Alarm Window.

(2) Indicate **Motion** detected. To disappear, press **[ESC]** button.

(3) Indicate **Video Loss** during Recording. To disappear, press **[ESC]** button.

---

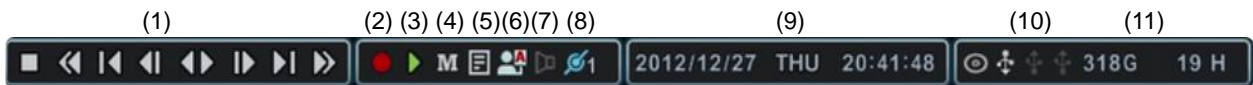

### 3. Status Bar



- (1) This ICON will be shown only on play back mode.
  - (2) Indicate **Recording** Status. Red is Recording. Click this ICON to toggle Record Start and Stop.
  - (3) Indicate **Playback** Status. Green is Playback. Click this ICON to toggle Playback Start and Stop.
  - (4) Indicate **Menu**. Click this ICON to popup the menu.
  - (5) Indicate **LOG**. Click this ICON to popup log history.
- => After click **Menu** and **LOG**, the status bar is changed like below picture.



Please click  ICON to clear **Menu** and **LOG**.

- (6) Indicate Login() or Locking status. Click this ICON to toggle Log in and out.
- (7) Indicate **Audio** Data is stored the selected time during playback and turn to blue color.
- (8) It shows **Number of Client**, which is connected to Network.(MAX:10)
- (9) Displays Month, Year, Time and Date. Change the order on System>Time.
- (10) Indicate an **USB Device is connected on Front panel and Rear panel**. It's changed to blue color while it's doing backup. Click this ICON to toggle Back up Start and Stop.
- (11) : Show you the remaining recording time of the NVR. If remaining HDD capacity is less than 5GB, this blue "Recycling" icon will be shown up.(DVD icon would not be shown some models if DVD-RW is not supported)

## 2. Multi-screen Display and Sequencing

### 2.1. Screen Display.

Select any camera for Full screen display by pressing the Number button of the desired camera. for 12ch, press 1 then 2.

### 2.2. Multi-screen Display and Switch Sequencing Display.

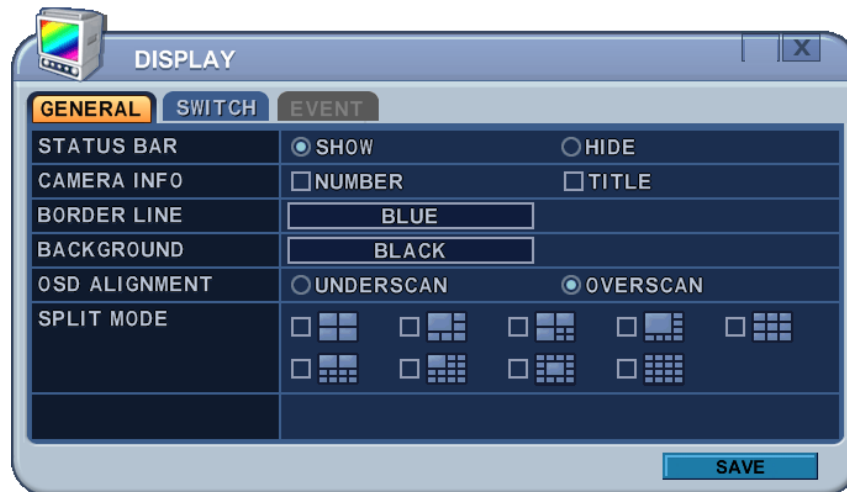

- 1) Press **[DISPLAY]** buttons to activate the multiscreen display. It is changed the order as shown below among your choice of SPLIT MODE.
- 2) To start Auto Sequence, press **[DISPLAY]** buttons for 2 seconds to begin full screen sequencing.

Click this ICON  by Mouse and spot out button on the remote control, you will see following virtual controller

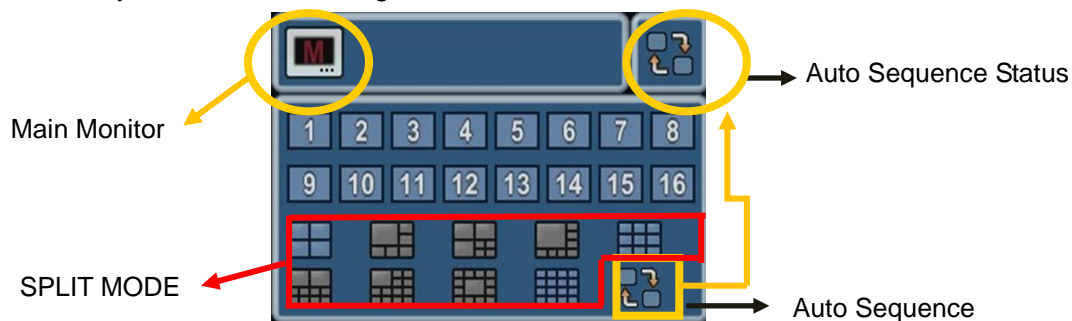

- 3) The Auto sequence mode and dwell times are programmable in Switch set up. For detailed information about configuring those, see “**Switch Setup**”. If the sequence mode is not activated, it moves to Quad mode instead of Sequencing.
- 4) The Split mode is programmable in General set up.

---

### 3. Quick button for multi screen Display.

#### 3.1. Quick multi split mode change

- Press F1 button on the remote controller + <Number>

For example, press F1 button then number 8.

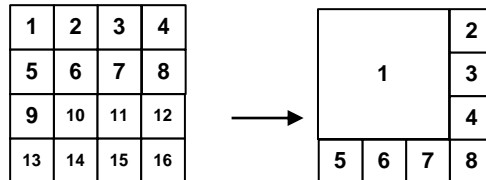

The eight channel view mode will be displayed.

**<Note>** 6,4,8,10,13 split mode must be checked on <Split mode> to use this function.

#### 3.2. Repositioning

It is possible to reposition the camera from the bigger window with the one from a smaller one. It is used on 6,7,8,9,10, 13,16 split mode

- ① Press **F2 button** on the remote controller.  Mark will be displayed.
- ② Press Numeric button you wish to switching display.

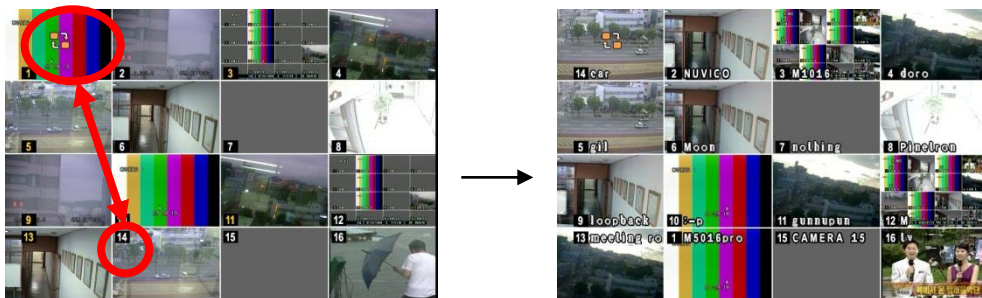

- ③ Press **[MENU]** button to exit here with saving changes.  
Press **[Cancel]** to exit without change.  
Press **[DISPLAY]** button to rearrange.







---

## 4. Zooming

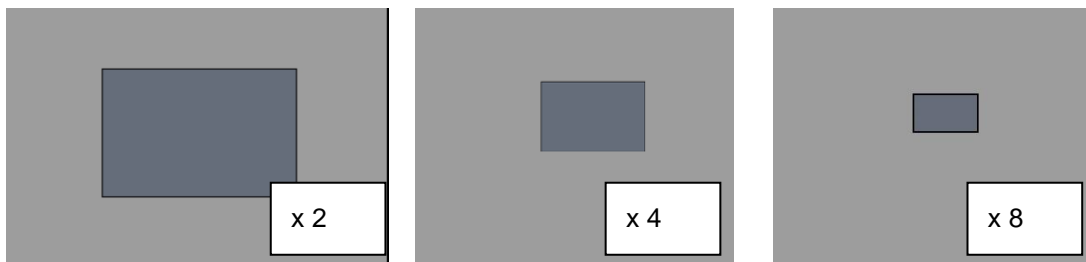
During live view mode, it is possible to zoom into a section of the screen to get a close-up view of the screen.

1. To activate the digital zoom, select the full screen display of the camera you wish to zoom.
2. Then press the **[ZOOM]** button on IR Remote controller. Zoom area box pops up, as shown below.



3. Move the box to the desired position using Direction [    ] buttons.
4. Press [+] button to enlarge the image. Press [-] button to zoom out the image.
5. Press [ESC] button to return normal mode.

### <Note>

- If the Zoom button is pressed while in a multi-screen display, zoom operation is not activated.



---

# V. OPERATION

## 1. LOG IN/OUT.

You must log on to the NVR with valid password to operate the NVR. By default, it comes with one login account; ADMIN and the default password is “000000”.

**<Note >** If you are logging on for the first time, the system does not prompt you to change the default password. Therefore, it's strongly recommended to change the “PASSWORD” when you install the NVR. Refer to [System Setup].

### 1. Login

- 1) On the front panel or remote control, press the power button.
- 2) When the NVR is powered on, it will start to scan NVR status.
- 3) Live Viewing screen will appear after initialization about 50sec. It can be delayed when you have defect HDD, it will try to fix for logical problem but it will show you warning message for physical problem.
- 4) On the remote control, press Login. Using the mouse, click the login icon, login dialog box pops up.



- 5) Login Icon  will be changed on status bar.

### 2. Logout

On the remote control, press LOGIN. Using the mouse, Press Login icon again, indication you are logged off.



---

## 2. NAVIGATION THE MENU

1. Log on the NVR at admin level or user with configure level.  
\* User with configure feature is limited to access [DISK and System Menu].
2. On the front panel or remote control, press **[MENU]**. Using the mouse, Right click wherever on monitor, Menu will be appeared.



3. Use Direction buttons [◀▶, +/-] to select the desired menu. Using the mouse, click the menu. Items selected .
4. Press [OK] button to select the menu and display Sub-Menu. Using the mouse, double click.
5. Use Left/ Right buttons [◀▶] to select on TAP menu. Selected items changed into **[Orange]** color.

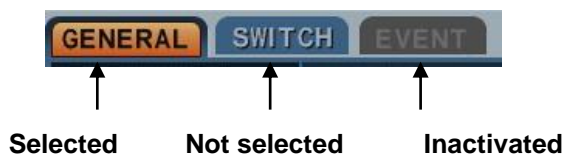

**\* It is automatically saved changes when you move between TAP menus.**

6. The menus are displayed with options on the left-hand column and settings in the right hand column. A cursor (highlighted menu) can be moved using the Direction buttons [▲▼◀▶].
7. Press **[-, +]** or **wheel** button to change the value or select options. By mouse, using Wheel.
8. Press **[SAVE]** button to exit a menu with saving changes.

Press [ESC] to exit a menu without changes.

# VI. SETUP

## 1. DISPLAY

### 1.1. GENERAL



1. The menus are displayed with options on the left-hand column and settings in the right hand column. A cursor (highlighted menu) can be moved using the Direction buttons [▲▼▶◀].
2. Change below options using [DEC/INC] buttons.

ITEM	ADJUSTMENT
STATUS BAR	<ul style="list-style-type: none"> <li>• Select “Show” or “Hide” below status bar on Main Monitor.</li> </ul> 
CAMERA INFO	<ul style="list-style-type: none"> <li>• Select On-Screen-Display information for Camera Number and Title.</li> </ul>
BORDER LINE	<ul style="list-style-type: none"> <li>• Select Board Line between cameras. [GRAY → WHITE →BLUE → BLACK →DARK GRAY]</li> </ul>
BACKGROUND	<ul style="list-style-type: none"> <li>• Select Background color on NO VIDEO status. [GRAY → WHITE →BLUE → BLACK →DARK GRAY]</li> </ul>
OSD ALIGNMNET	<ul style="list-style-type: none"> <li>• The main video output can be displayed on a VGA and analog monitor. Video can be displayed on both monitor simultaneously. Select On-Screen-Display coordinates on Monitor. <ul style="list-style-type: none"> <li>- Under scan: Displays properly at CCTV Monitors</li> <li>- Over scan: Displays properly at VGA Monitors.</li> </ul> </li> </ul>
SPLIT MODE	<ul style="list-style-type: none"> <li>• Display is changed the order as shown below among your choice of SPLIT MODE.</li> </ul>

3. Save changes and exit the menu, press [SAVE] button.  
Exit the menu without making changes, press [ESC] button.

## 1.2. SWITCH Setup (Monitor Configure)



The menus are displayed with options on the left-hand column and settings in the right hand column. A cursor (highlighted menu) can be moved using the Direction buttons [▲▼◀▶].

### 1. Settings

- 1) Device: It is set by Main monitor .
- 2) Dwell Time: Select the interval that each camera or Multi screen mode is displayed in a rotation. Use [-, +] button to change : [1 second ~ 30 second]
- 3) Mode: Select the appropriate monitor display to making any adjustment. This Mode will be activated while it's in Switch Mode.
  - a. **Sequence:** Automatic Sequence.
  - b. **Shift:** Selected camera will be displayed after dwell time.

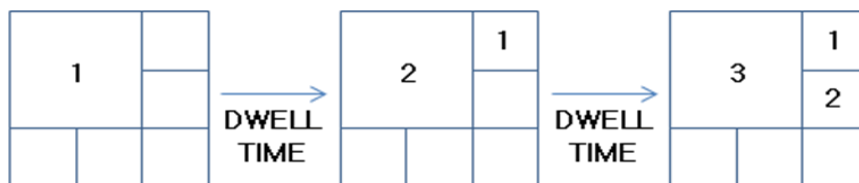

- c. **Event:** To display particular camera in full screen or in multi mode when event triggered.



- 4) SPLIT MODE : Select desired sequence mode to switching.
- 5) USE CHANNEL: Select the cameras to be included or excluded from the automatic

switching.

2. Save changes and exit the menu, press [MENU] button.

Exit the menu without making changes, press [ESC] button.

3. Press [Display] button for 2 seconds to start Auto Switch cameras on Main Monitor.

Press [Spot] button then [Display] for 2 seconds to start auto switch cameras on Spot Monitor

### 1.3. EVENT

This menu will be activated when you select <EVENT> Mode for Switch. Event menu will allows customization of motion, alarm and video loss.



When selected event trigger such as alarm, motion or video loss, it will be displayed at the monitor that is configured for event.

## 2. CAMERA



Press Left/Right buttons [◀▶] or number button to select the desired camera  
 Camera will be activated if IP Camera is connected. Camera Channel option is highlighted and the camera settings are displayed.

### 2.1. CAMERA

ITEM	ADJUSTMENT
CONNECTION	<ul style="list-style-type: none"> <li>Select connection method</li> <li>- Auto : PoE camera connection (PoE Port)</li> <li>- Manual : None PoE camera connection (LAN OR IP CAM Port)</li> </ul>
PROTOCOL	<ul style="list-style-type: none"> <li>Select camera type</li> </ul>
TITLE	<ul style="list-style-type: none"> <li>Put the camera name</li> </ul>
IP INFO	<ul style="list-style-type: none"> <li>Show camera brief information</li> </ul>
CONFIGURATION	<ul style="list-style-type: none"> <li>Set up details about camera</li> </ul>
PTZ	<ul style="list-style-type: none"> <li>Set up PTZ camera</li> </ul>

### 2.2. Set up IP camera **MANUAL CONNECTION**

- 1) Select "MANUAL" on connection after that USE check box and SETUP button will be shown like below picture.
- 2) Select USE check box and press SET UP button to put IP camera information
- 3) Put user ID, PW , IP address and port of IP camera.



2.3. Press SETUP button on CONFIGURATION to see detail information or set up function of camera.

1) INFO



- **MODEL BRIEF :**  
IP Camera information
- **HOSTNAME :**  
IP Camera's own name
- **STATUS :**  
Show temperature of IP camera
- **VERSION :**  
: Show current version of IP camera

2) CAMERA



ITEM	DEFAULT	ADJUSTMENT
Day & Night	Auto	<ul style="list-style-type: none"> <li>• Control True Day/Night (TDN) operation. [Auto – DAY – NIGHT]</li> <li>- When Auto is selected, the IR-cut filter will be off automatically in low-light scenes.</li> <li>-When Day is selected, the IR-cut filter is on at all times.</li> <li>- When Night is selected, the IR-cut filter is removed at all times.</li> </ul>
DNR	Middle	<ul style="list-style-type: none"> <li>• Improve picture performance in low light by reducing video noise. [ Off- Low- Middle- High]</li> </ul>
Enhancement	OFF	<ul style="list-style-type: none"> <li>• Select Off, BLC and WDR as a backlight revision.</li> </ul>
White Balance	Auto	[ Auto - Auto High - Auto Low]
BRIGHTNESS	50%	<ul style="list-style-type: none"> <li>• The brightness of each camera can be adjusted by pressing [-,+ ] buttons.</li> </ul>
CHROMA	50%	<ul style="list-style-type: none"> <li>• The chroma of each camera can be adjusted by pressing [-,+ ] buttons.</li> </ul>
ORIENTATION	NONE	<ul style="list-style-type: none"> <li>• Set the way of reversing the image as up and down[<b>FLIP</b>], left and right[<b>MIRROR</b>]</li> </ul>



## 2.4. DEVICE

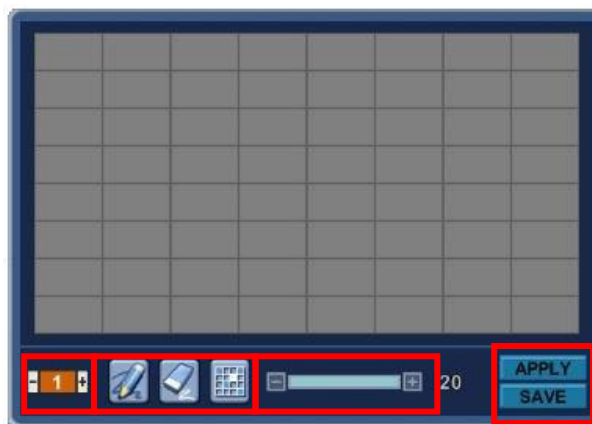

### 1) MOTIOM

Press SETUP button to set up motion function.



- a. Motion Zone : Set up to 4 Motion areas defined by selected parts.
- b. Motion Grid : The area property is highlighted and motion detection can now be observed in the view window. **By default, it's set to OFF.**
  -  : Select All. Press [OK] to select.
  -  : Clear All. Press [OK] to select.
  -  : Select specific. Press [OK] to select.
- c. Motion Level : The sensitivity settings are : 1: Low sensitivity ~ Level 20: High sensitivity. **By default , the level is set to 10.**
- d. APPLY : Save changed set up.
- e. SAVE : Save changed set up and exit automatically.

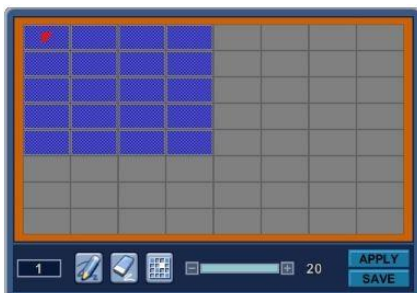

To define the motion view area cell-by-cell, do the following:

On the front panel or remote control, press any of direction buttons to highlight a cell in the motion detection area, then press [OK]. This area is selected and the cells are highlighted in a blue color.



## 2) Zoom [Easy Focus]

: This Menu will be activated when Easy lens installed. Even you think the focus is perfectly set through potable monitor, HD monitor displays a blur image. After Zooming in/out, the view will be automatically focused.

## 2.5. Advanced Setting.

To access more controlling of IP Camera, please try to connect trough EMS 2 S/W,

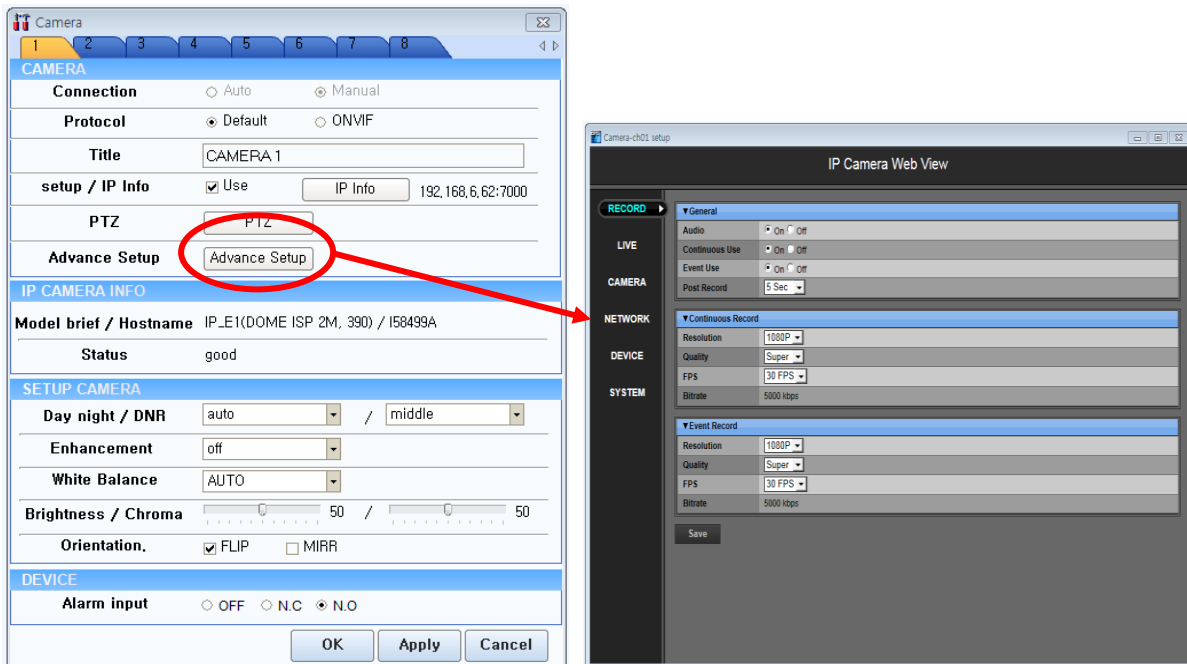

## 3. RECORD

### 3.1. Record General



1. The menus are displayed with options in the left-hand column and settings in the right hand column. A cursor (highlighted menu) can be moved using the directional buttons [**▲▼◀▶**].
2. Change the options shown below using the [DEC/INC] buttons.
  - 1) **Schedule Use:** This enables or disables Night Zone. **By default "OFF"**.
  - 2) **Boot up Record:** The NVR starts recording without pressing the [REC] button when it is set to **"ON"**.
  - 3) **Disk Overwrite:** Selects the record policy of the hard disk drive.
    - **ON: By default**, the hard disk drive overwrites from the beginning when it becomes full.
    - **OFF:** Stops recording when the HDD is full.
  - 4) **Auto Delete:** Allows you to configure when the NVR automatically deletes all data from HDD. It leaves the data for a selected duration from the current time. [NONE → 12HOURS → 1DAY~ 6DAYS → 1WEEK ~ 4WEEKS-> 30 DAYS]
  - 5) **Pre-Record:** Determines the duration the NVR stores recorded video prior to the beginning of Event Recording [**5SEC ~ 300 SEC**]. **By default 5 sec.**
  - 6) **Post- Record:** Determines the duration the NVR continues to record for after an Event detection [**5SEC ~ 300 SEC**]. **By default 5 sec.**

**<Note>**1. Alarm/Motion Duration is extended if there is another Alarm/Motion detected whilst Event Recording.

2. When recording, the Pre-Record and Post-Record will not be activated.

3. To save changes and exit the menu, select [save] then press the [MENU] button.

4. To exit the menu without making changes, press the [ESC] button.

### 3.2. Continues /Normal Recording

The NVR comes with certain preset settings from the factory. Therefore, once the NVR is installed immediate recording is possible by pressing the record button. By default, audio, alarm, motion recording are off.



The NVR records video data continuously over a 24 hour period. Recording setup is for normal recording. Different settings can be configured for each camera. To copy the setting to another channel, press **[Display]** button.

ITEM	ADJUSTMENT
Audio	• Select Audio Record ON/OFF
RES.	• Display selected resolution in MODE tab.
RATE	• Select recording speed for each camera.
QUALITY	• Specify the record picture quality for each camera. SUPER → <b>HIGH</b> → MIDDLE → LOW

### 3.4. Event Recording

Users can set different event recording parameters on a camera by camera basis. Set the continuous recording to [OFF] and configure the Event Recording speed and Quality for each camera.



Determine whether Alarm, Motion, Video Loss is used for EVENT recording on the [DAY EVENT] tab.

#### 3.4.1 Alarm Recording

One Alarm input can be configured to one channel. One camera channel can be assigned to multiple alarm inputs.



- Press [-, +] button to change the value or select options. With a mouse, use the wheel.
- [\*] indicates multiple alarm sources are selected.
- Please refer to [Device/Alarm] for Alarm inputs and outputs.

### 3.4.2 Motion Recording

One Motion detection can be configured to one channel. One camera channel can be assigned to multiple motion detection.



- Press [-, +] button to change the value or select options. With a mouse, use the wheel.
- [※] indicates multiple alarm sources are selected.
- Please refer to [CAMERA] menu for Motion setup.

**<Note>** There may be cases when the recorder's built-in motion detection function does not operate properly due to the condition of the input video signal or other factors.

### 3.4.3 Multi Event Recording

- 1) Video Loss:** When Video Loss occurs it can be configured to one channel. One camera channel can be assigned to multiple Video Losses



## 2) Event Edit



- Press [OK] to edit multiple events. The menus are displayed with options in the left-hand column and settings in the right hand column. A cursor (highlighted menu) can be moved using the directional buttons [▲▼◀▶] on the IR remote or front panel.



- Change options using the [DEC/INC] buttons on IR remote or by clicking the mouse button.
- System menu are not activated in this section

### 3.5 Continuous + Event (Motion/Alarm) Recording

Continuous and Event recording can be set simultaneously. The NVR records video continuously over a 24 hour period, but if an Event occurs, the recording speed and picture quality can be set to values different from continuous recording values.

<Example>



Pressing the **REC** button, **Normal** recording starts with High picture quality at 6F/S. When an **Event** is triggered on this channel, it changes to record with Super picture quality at 30 F/S. It reverts back to **Normal** Recording after the Event duration ends.

**<Note>** Please determine Event source, such as Motion, Alarm, Video Loss on the [DAY EVENT] tab.



## 4. SCHEDULE

When the schedule is on, users can define their own daytime, night time, as well as specified date settings. A schedule can be used to record selected cameras at different times, change record rates, and select whether Alarm or Event is enabled. By selecting Schedule Use “on” Record setup, Night Mode will be activated.



### 4.1. CHART Setup

The schedule chart shows a graphical representation of the defined record mode. Night mode will be set by default. However, the schedules are only displayed if a corresponding schedule has been configured in the schedule menu.

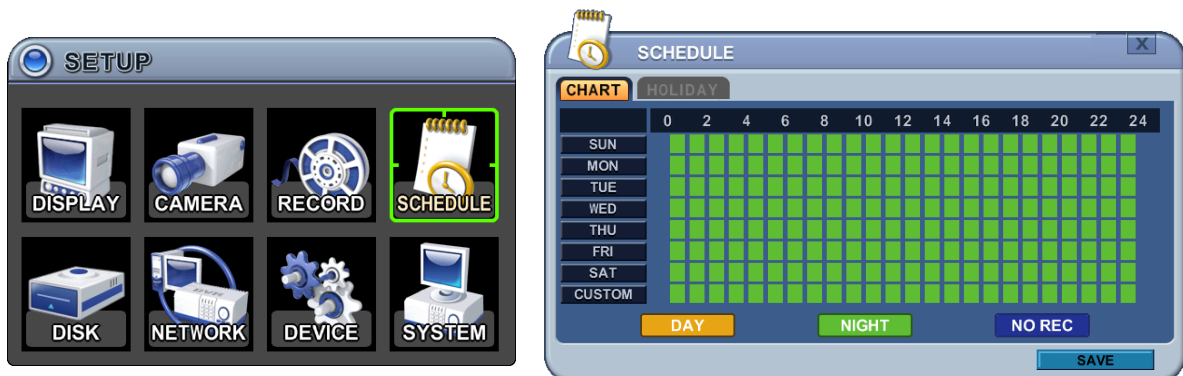

- \* DAY (Yellow): Follows day setting on record.
- \* Night (Green): Automatically follows night setting.
- \* No Record (Blue): The video is displayed, but is not recorded.

- 1) A cursor (highlighted menu) can be moved using the directional buttons [▲▼◀▶].
- 2) Select each day to configure, press [OK] or click the mouse button.
- 3) Detailed menu pops up for the selected day, as shown below.



- a. Use [-, +] button to change the values.
    - Mode : [Night] → [Day] → [No Rec]
    - BEGIN: The time recording starts.
    - END: The time recording ends. The end time must not be before the starting time or the same as the starting time.
  - b. Save changes and exit the menu, select [save] then press the [OK] button.  
Exit the menu without making changes, press the [ESC] button.
- 4) Copying Schedule
- a. A cursor (highlighted menu) can be moved using the directional buttons [▲▼◀▶] on Day (Sun – Sat)
  - b. Press [Display] button on the desired setting.





---

## 4.2. Holiday Setup

This allows you to create up to 32 holidays. If a holiday schedule occurs on the same date as a weekday schedule, the holiday schedule overrides the weekday schedule.

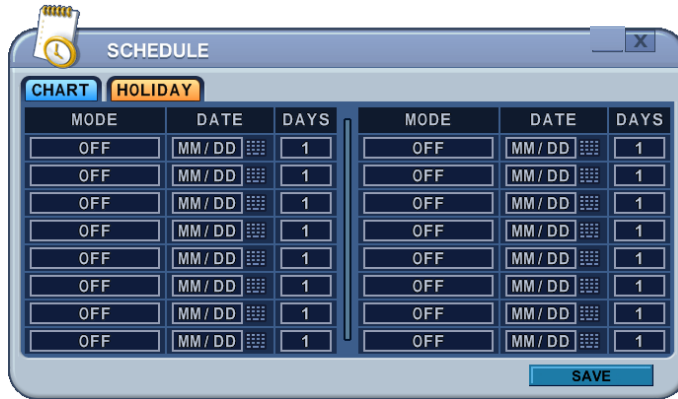

- 1) A cursor (highlighted menu) can be moved using the directional buttons [**▲▼◀▶**].
- 2) Select each day to configure, press [OK] or click the mouse button.
- 3) Use the [**-**, **+**] buttons to change the values.
  - Mode : [**OFF**] → [**Day**] → [**Night**] → [**No Rec**] → [**Sun~Sat**] → [**Custom**]
  - Date: The date Holiday starts.
  - Days: The holiday duration [1 to 15 days].

## 5. DISK

### 5.1. DISK Manager

Disk Manger is used to format hard disks and to assign the HDD usages, such as back up or mirroring.



#### 1. Select

- 1) The menus are displayed with options for all installed HDD's or ODD list.
- 1) Press up/down [**▲▼**] buttons to highlight Hard Disk or ODD, then press [**-**, **+**] button to select. Using the mouse, click the HDD option.
- 2) Device & Size: This information lists the installed drives and their respective capacities, which is not currently used.
- 3) Status:
  - a. Unknown: New installed Disk.
  - b. Empty: Formatted but not used in current NVR.
  - c. CD/DVD: CD or DVD is installed for back up use.
  - d. Record Data: HDD stored Recording data but not used in current NVR.
  - e. Back Up Data: HDD stored Back up data.
  - f. Other Data: Neither Back Up nor Recording Data, including AVI file.

<Note>: Disconnected Disks disappear from the Disk Menu.

#### 2. Action :

- 1) None: By default.
- 2) **Assign to Record Disk**: Initialize the selected HDD. It formats the drive and all data on the drive is erased. External SATA HDD can be used to extend HDD capacity. Selected HDD will move to [Recording Disk] after formatting.
- 3) **Mirror: Mirror on INT -A**  
:This NVR utilizes two internal/external HDD's for recording. Writing duplicate data to other HDD in order to protect against loss of data in the event of a device failure.

**\*<Warning> This HDD must be same with or bigger than original size.**

4) **Assign to Record & Mirror:** This menu is activated when you select two HDD's at the same time. It automatically configures one HDD for Recording and the other for Mirroring.

5) **Initialize for Back Up:**

Selected device, such as Media or External HDD, is formatted for backup use. Here's the guide for backing up data to various devices.

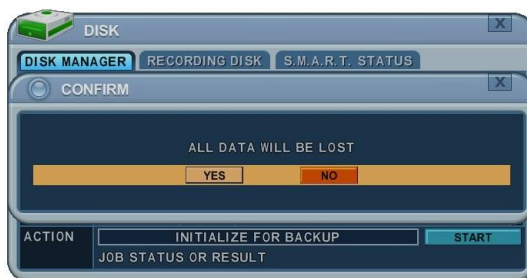

Once you press the start button, this pop-up window is displayed to ask you to confirm the initializing for back up: YES or NO.

6) **Link Record Disk**

: This function is used for adding [used HDD] from the same model without formatting.

**< Note: There are limitations for using this function >**

- A. NVR should be empty (NO HDD). If RECORDING DISK's exist it does not work.
- B. The used HDD should be from same series. It's does not work with different series.
- C. There should be no time duplication in the HDD.

Device	ODD (Media)		HDD	
	CD/DVD±R	CD/DVD ±RW	SATA	USB
Media can be formatted	X	O	O	X
Device can be formatted on a PC using FAT 32, NTFS File system.	X	X	O	O
Media must be formatted on NVR before backing up or exporting data to the device.	X	O	△	△

**<Note1>** USB flash memory is working without format.

**<Note2>** if a FAT32 /NTFS formatted external USB device is installed, <Assign to Record Disk> feature is disabled. It's limited to back up only.

3. Press the [ +] button to start selected action.

4. Save changes and exit the menu, select [save] then press the [MENU] button.

Exit the menu without making changes, press the [ESC] button.

## 5.2. Recording DISK

This information lists the installed drives, how the NVR records video and their respective capacities which are currently being used for recording.



### 1. Size, Range

: This displays current recorded data size, HDD size and indicated stored data range, and where the writing progress is running

### 2. Device

Displays logical Master and Slave device in mirroring. Upper device is the Master and the other is used for slave. If the slave HDD reaches 100% synchronisation, Master HDD can be removed as well.

### 3. Status

- 1) Stable: The HDD is in a stable condition.
- 2) Re-sync: Force all pending buffered disk writes to the NEW installed disk.
- 3) Recover: Recover all mismatched data between the mirrored disks.

### 4. Action: Remove HDD.

The "Are you sure?" dialogue box opens.

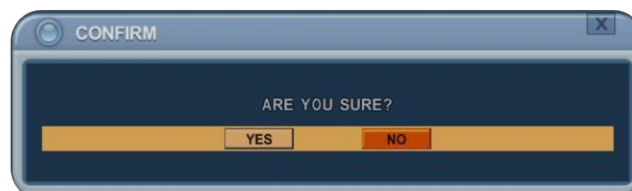

Press the up/down [↕] buttons to YES or NO, then press the [-, +] button to select.

---

### 5.3. S.M.A.R.T STATUS



The screenshot shows a window titled "DISK" with a sub-tab "S.M.A.R.T. STATUS". It displays a table with the following data:

NO	ID	BAD	TEMP	TIME	STATUS
1	INT-A	0	35 °C	50 D	GOOD
2	INT-B	0	36 °C	50 D	GOOD
3	INT-D	22	39 °C	50 D	GOOD
4					
5					
6					
7					
8					

Displays HDD information, such as Bad Sector, Temperature and HDD running time. S.M.A.R.T information has slight differences between depending on the HDD manufacturer. We recommend changing the HDD if its status is in <PRE-FAIL>

**\*NOTE : Please refer to STATUS explanation**

Status	Explanation
GOOD	GOOD
PRE-FAIL	Alerts that may be a problem
PAST PRE-FAIL	"PRE-FAIL" occurred before
FAIL	Find problem / need to replace

---

## 6. NETWORK

A static service consists of an IP address that remains constant for the duration of the contract of the internet service, whereas a dynamic service has an IP address that changes every time a new connection is made through the provided modem, or recurrently in a given period of time. Though most internet service providers offer both solutions, this manual will distinguish between the two solutions, according to the commonly available service types, to configure the NVR for the networking purposes.

### 6.1. LAN Port & IPCAM Port



#### 1. LAN PORT

- 1) Config : Select IP address type.
- 2) IP Address: Enter the static IP address
- 3) Netmask: Enter the IP address of the subnet mask.
- 4) Gateway: Enter the IP address for the internet gateway server.
- 5) PRI.DNS Server: Verify the name of the domain name system.
- 6) SEC.DNS Server: Enter the IP address of the backup domain name system (DNS) server that the NVR will use to convert name to IP address. This server is used if the primary DNS server fails.

**<Note> if you do not set up the DNS server correctly, it will have problem with mail sending.**

#### 2. IP CAM port Setup

- 1) Config : Select IP address type.
- 2) IP Address: Enter the static IP address
- 3) Netmask: Enter the IP address of the subnet mask.
- 4) DHCP Service : Select On or OFF to activate
- 5) DHCP IP Range : If user select DHCP service On , available IP address is displayed in Netmask.

## 6.2. GENERAL

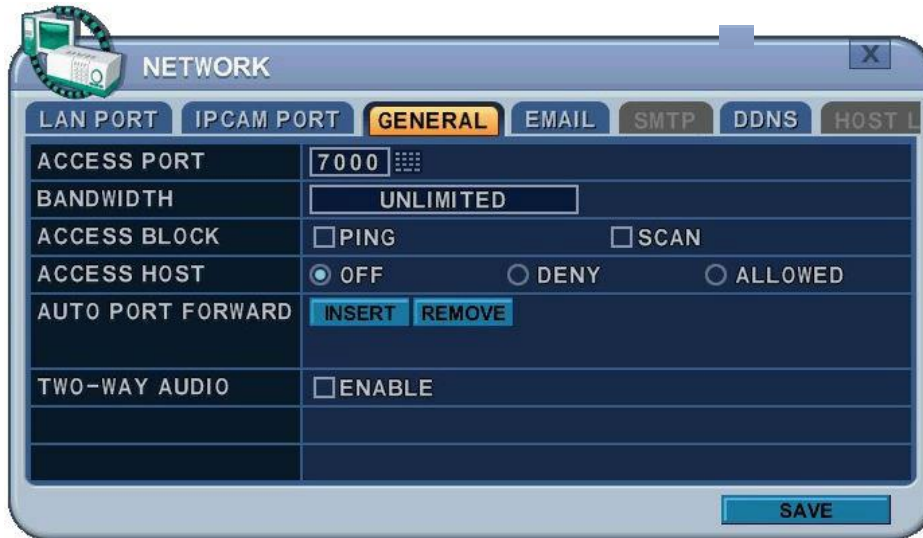

1. Access Port: Select "0001 ~ 9999"  
Enter the port number the client uses to communicate with the NVR over the internet. The default port is 7000. It is recommended to use a port above 1000.
2. Bandwidth: Select the network bandwidth to limit the amount of network resources allocated to client connection. The default is unlimited: " 4 Kbps ~ 8 Mbps"
3. Access Block 1) Ping Block: No response to ping. By default OFF.  
2) Scan Block: No response to Auto Scan from EMS. By default OFF.
4. Access Host and Host List: Allows you to access or deny specific IP address.  
To allow or deny remote access requires you to enter a range of IP addresses as an IP address and mask. Host List will be activated when you select deny or allowed.



5. Auto Port FWD: Select the ADD button to automatically open ports for Router communication with UPNP compliance.
6. 2 Way Audio: Support 2 way Audio between NVR and Remote Software



### 6.3. EMAIL

This NVR allows you to specify the events that generate notification. Sends e-mail notification if an event occurs, such as alarm, motion detected etc.

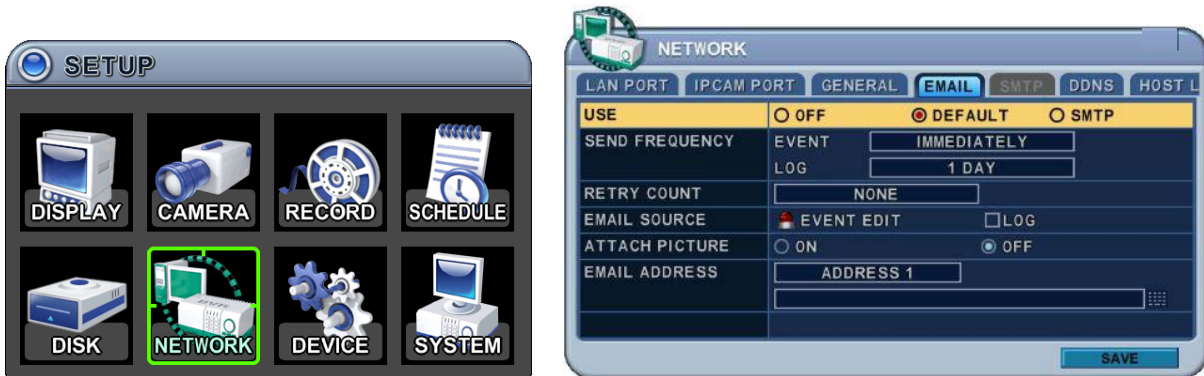

The mail server can use either the NVR mail server or your existing e-mail settings.

The menus are displayed with options in the left-hand column and settings in the right hand column. A cursor (highlighted menu) can be moved using the directional buttons [**▲▼◀▶**].

1. **USE:** Select the e-mail notification ON or OFF. The default is OFF. Press the [**-**, **+**] buttons to select. Using the mouse, click the option to select mail server.
  - 1) **Default:** Default it is provided by manufacturer. Mail notification options and mail address settings are available.
  - 2) **SMTP:** SMTP Configuration tab is activated to set up your own mail settings.
2. **Send Period:** e-mail will be sent at selected intervals.
  - 1) Event: [Immediately, 10 Minutes, 1 hour, 1 Day]
  - 2) Log: [1 Day, 1 Week]
3. **Retry Count:** Select the number of retry attempts to send e-mail after failure.
4. **E-mail Source:** Event must be specified using notification options.
  - 1) Event Edit. Notifications can be enabled for each channel for Alarm, Motion, Video Loss and System (HDD Fail, Record Fail, HDD Full etc.). Press the [OK] button to select.





5. Log: This NVR will mail Log List at selected intervals.
6. Attach Picture: While in recording mode, a picture can be attached to mail.
7. E-mail Address: 5 mail addresses can be configured for mail notification.

## 6.4. SMTP

This menu is activated when you check <SMPT> on EMAIL.

The following settings are only needed if you are NOT using the NVR mail server.



1. Server: Enter the e-mail server name or IP address. To set server name, use the virtual keyboard, or press the appropriate numeric button on IR Remote or front panel.
2. Port: Define the port the SMTP server will communicate through. By default, it is set to 25.
3. Authentication: Check this <ON> if your mail server requires authentication.
4. User ID & Password: Enter the user ID/name and password for the SMTP Server.  
(Distinguish Upper and Lower Case : use Lower case by Front or IR remote, press [OK] button at this cell, virtual keyboard will be pops up.)
5. Send Test: Test to send e-mail.
6. Save changes and exit the menu, select [save] and press the [MENU] button.  
Exit the menu without making changes, press the [ESC] button.

## 6.5. DDNS (Dynamic DNS)

This NVR offers free dynamic DNS update. It keeps track of your changing IP address. It's easiest to use.

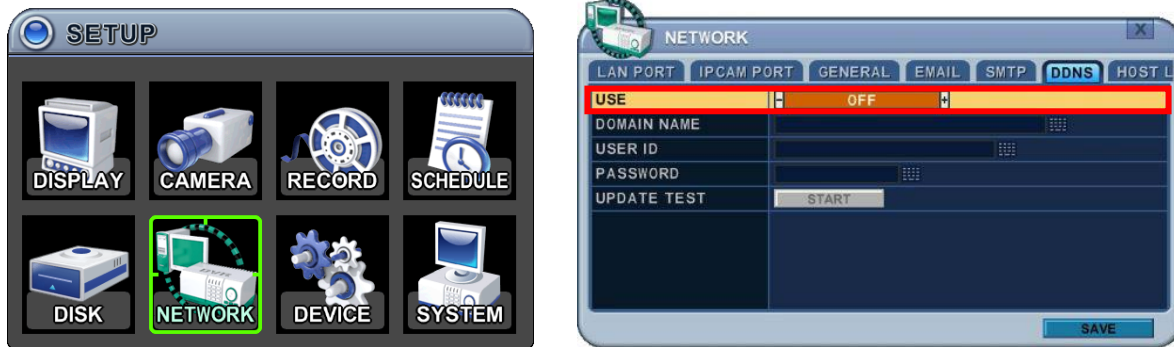

The menus are displayed with options in the left-hand column and settings in the right hand column. A cursor (highlighted menu) can be moved using the directional buttons [▲▼◀▶].

1. **USE:** Select one method among DDNS OFF, Default, DYNDNS and NO-IP. The default is OFF. Press the [-, +] buttons to select. Using the mouse, click the option to select DDNS provider.

1) **Default:** Default it is provided by manufacturer. We offer DDNS service for remote at <http://www.dvrhost.com>

If you are using <Default> for DDNS, you do not need to setup anything. It does not allow you to create a host name; it's provided by the NVR. Press the [info] button on IR remote or select  icon on the menu, then check your host name and Mac address.



For example,  
<http://G5837A0.dvrhost.com:7000>

- 2) **DYNDNS:** To use your own domain name service or "dyndns.com"

- 
2. The following settings are only needed if you are NOT using the default.
    - 1) Domain Name: Enter the name you set for the DDNS web configuration.
    - 2) User ID: Enter your user ID.
    - 3) Password: Enter your password.
    - 4) Update Test: Click the Update Test button to confirm the connection. A success message will appear.
  
  3. Save changes and exit the menu, press the [MENU] button.  
Exit the menu without making changes, press the [ESC] button.

## 6.6 Router & Port Forwarding

A majority of networks will often consist of a single IP address which shares internet access through a router. This IP address may be any external (public) static IP address or any dynamic IP address issued by the Internet Service Provider.

The purpose of a router is to enable multiple personal computers and any other devices that require internet connection to access the internet simultaneously. Most routers by default enable (open) commonly used ports so that mainstream applications such as Hypertext Transfer Protocol (HTTP, Port 80), File Transfer Protocol (FTP, Port 21), Telnet (Port 23) and Post Office Protocol 3 (POP3, Port 110) are used.

To solve the firewall problem, and let a visitor into the network, the user instructs the router to allow traffic to pass through on a given port. This is known as Port Forwarding, as the router forwards (directs) all internet requests on a specific port to the local machine. With port forwarding, external visitors are able to connect to the NVR while other internal devices remain protected.

Here is the example of NVR connection.

Network	Router	NVR IP Setting	PC Connect position			PC Connect position		CF
			① LAN			② WAN		
			A	B	C	B	C	
Static IP	use	STATIC	○	△	⊗	★	★	
		DHCP	○	▲	⊗	☆	★	Check the NVR IP of info and set into Router.
	x	STATIC	○	○	○	○	○	
		DHCP						N/A [Need Local DHCP Server]
DHCP	use	STATIC	○	△	⊗	★	★	
		DHCP	○	△	⊗	★	★	Check the NVR IP of info and set into Router
	x	STATIC						N/A
		DHCP				△	△	PPPOE is not supported

---

1) Description of Location.

- A. LAN: Connect by Local IP. If you are connecting from within your network you only need to enter the IP address of the system into the S/W (example 192.168.0.50)
- B. WAN: Connect by DDNS. If you are connecting from outside your network use the DDNS to configure the S/W (example L123456.dvrhost.com).
- C. WAN: Connect by IP address. If you are connecting from outside your network and if you know your Static IP address, use the IP address to configure the S/W (example <http://124.137.23.72:6000> ).

2) Description of Symbols.

- : Connected.
- x : Not able to connect
- △: There's some limitation - depends on Router or Network connection
- ★ : Need to use Port Forwarding

3) Description of Colors.

- Yellow - Recommended
- Grey - Not available
- White – Depends on Router or Network condition.

2. How to use NVR for DHCP

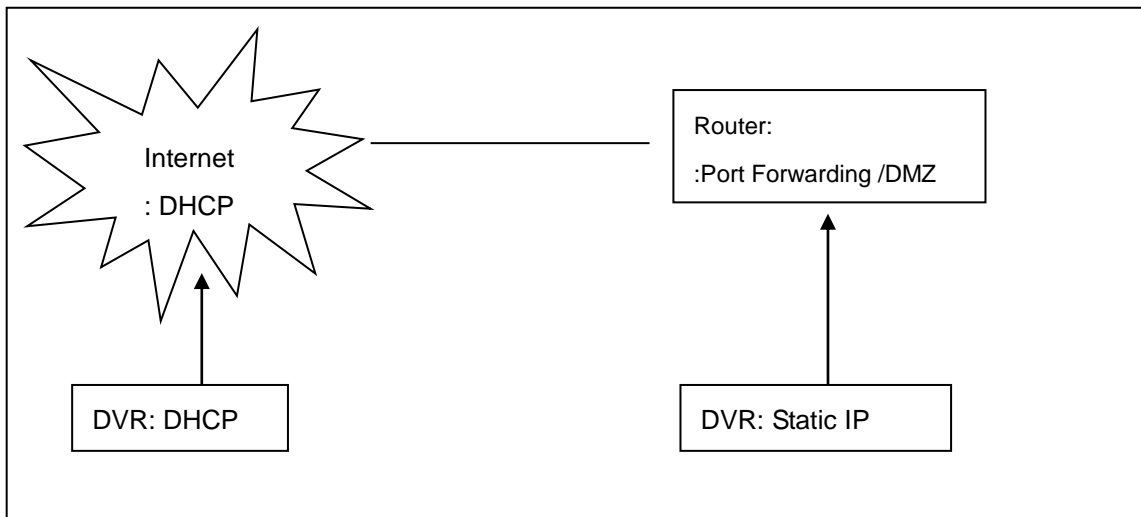

**<Note>** Each Router has different port forwarding settings. Please refer to the router manual or contact to your router manufacture for assistance

## 7. DEVICE

## 7.1. GENERAL



1) DISPLAY : Please decide output video resolution

- It can be set to the correct video resolution on the monitor.

[1920\*1080P(default) → 800\*600 → 1024\*768 → 1280\*720 → 1280\*1024  
→ 1600\*1200 → 1680\*1050 → 1920\*1080!]

- **HDMI AUTO**

Automatically detects and sets the HDMI resolution on the monitor connected to the NVR. It might display “no video” if a VGA monitor is not able to support high resolution.

<NOTE>In order to connect HDMI and VGA output to use both monitors, please set up as the lowest resolution without selecting HDMI AUTO.

- 2) Keypad Model: Select Joystick Controller and Baud Rate.
- 3) Extend Device: Select a model of POS/ATM.
- 4) PTZ Event: DURATON [OFF,1SEC ~ 5 SEC]: Select PTZ EVENT duration.
- 5) Alarm Out: DURATON [OFF,1SEC ~ 5 SEC]: Select Alarm duration.
- 6) IP CAM SET UP :

After click **SETUP** in the menu, all IP cameras which are connected in LAN network will be listed in the IP CAM Discovery menu.



A. HOST ID : It shows HOST ID of IP camera.

Please check IP camera which user want to see in monitor.

- B. IP : It shows current IP address of IP camera.
- C. MODEL : It shows type of IP camera.
- D. CHANNEL : User can assign channel and set up information about ID, PASSWORD and network setting.





**Note. Even though ID and PASSWORD is incorrect, it shows in live monitor.  
But user cannot change IP camera's setting in camera menu.**

- 2. Save changes and exit the menu, press the [MENU] button.  
Exit the menu without making change, press the [ESC] button.

## I/O Terminal

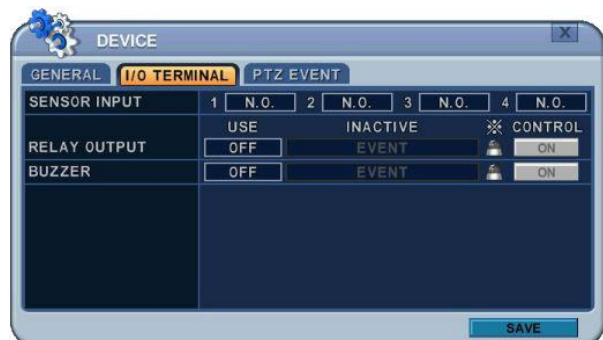
This NVR supports 4 Alarm Inputs and 1 x Relay Outputs.



- 
2. Use the Left/Right buttons [◀▶] to select “I/O Terminal” menu tab. The menus are displayed with options in the left-hand column and settings in the right hand column. A cursor (highlighted menu) can be moved using the directional buttons [▲▼◀▶].
  3. **SENSOR INPUT:** Change the input type. Use the [-, +] buttons to change the values.  
**Note. Alarm of IP camera can be configured in CAMERA menu (Chapter 2.2)**
  4. **RELAY OUTPUT:** you can configure how the Relay Outputs are controlled: automatic or manual.
    - 1) **Use:** Change the output type.
    - 2) **Inactive:** Select turn off method of Relay Out.
      - a. **Event (Automatic):** Relay Out is turned OFF when the event expires. This setting is configured globally.
      - b. **Manual:** Relay Out is turned OFF from this menu <Control>.
    - 3) Event Edit 
- Press [OK] to edit multiple events. The menus are displayed with options in the left-hand column and settings in the right hand column. A cursor (highlighted menu) can be moved using the directional buttons [▲▼◀▶] on the IR remote or front panel.



-Change the options below using the [DEC/INC] buttons on the IR remote, or click the mouse.

-System menu contains below

2. HDD Disk Fail
3. Record System Fail
4. Temperature Warning.
5. Fan Lock Warning
6. Voltage Warning
7. Low RTC Battery Warning
8. External Device Event
9. Network Link Disconnected



- 
- 10.Admin Login
  - 11.Power Recovery
  - 12.Disk Full
  - 13.Invalid Password in Sequence
  - 14.Auxiliary Event (Reserved )

4) Control: Manual stops for relay output and buzzer.

5. Buzzer

1) USE

- **ON:** The Buzzer sounds if an alarm is triggered. The buzzer sounds for the duration of the RECORD TIME. This buzzer relates to Alarm Out. Configure Alarm Out to “ON” for Alarm Buzzer.

- **OFF:** Disables the ALARM BUZZER function.

2) **Inactive:** Select turn OFF Buzzer

**a. Event (Automatic):** Buzzer is turned OFF when the event time expires.

**b. Manual:** Buzzer is turned OFF from this menu <Control>.

5. Save changes and exit the menu, press the [MENU] button.

Exit the menu without making changes, press the [ESC] button.

### 7.3. PTZ EVENT

When an Alarm is triggered, Motion detected or Video Loss occurs, this NVR sends a preset command to a PTZ camera. The PTZ option must be enabled and a protocol must be assigned to the camera channel.

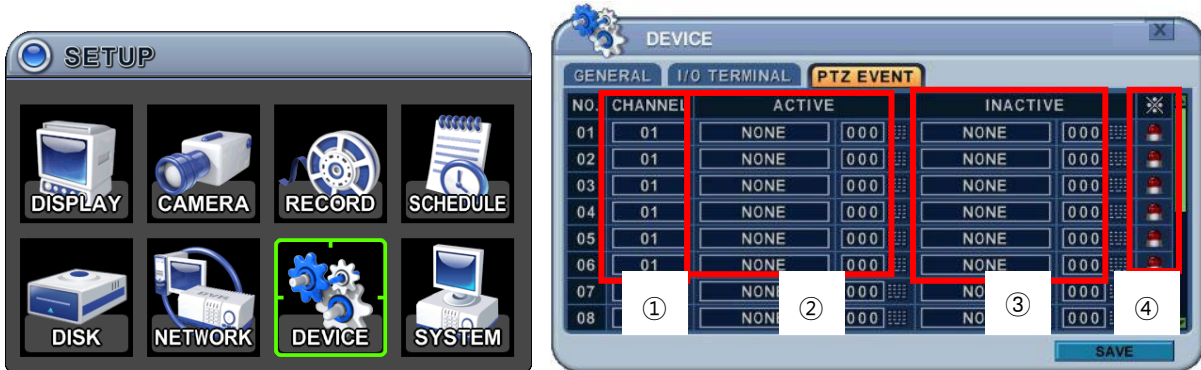

1. Channel: Select desired PTZ camera.
2. Active: Configure PTZ action [ **NONE** → **GOTO** → **TOUR** ] and Preset number or Tour group when an event is detected.
3. Inactive: Select Camera position after the event duration expires.
4. Event Edit. 

Press [OK] to edit multiple events. The menus are displayed with options in the left-hand column and settings in the right hand column. A cursor (highlighted menu) can be moved using the directional buttons [▲▼◀▶] on the IR remote or front panel.



**<Note>** Do NOT set up Motion detection on the PTZ camera used for a PTZ event. The signal will be looped.

5. Save changes and exit the menu, press the [MENU] button.  
Exit the menu without making changes, press the [ESC] button.

## 8. SYSTEM

### 8.1. GENERAL

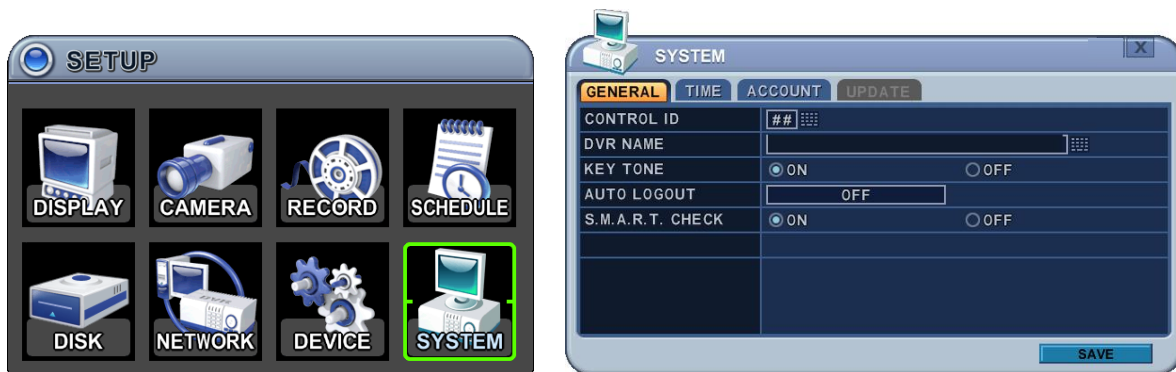

1. **Control ID:** Each NVR that is preconfigured with the control ID is enabled to respond to, and be operated by, the remote control.
  - To select the NVR to be controlled with the remote controller, press and hold the NVR ID button. While holding the NVR ID button, press the appropriate NVR ID number. For example, enter 05 for NVR ID 05, enter 43 for NVR ID 43 etc. Set the ID of IR controller on "00" to control multiple NVR's at the same time, whatever the NVR ID is.
2. **Device Name:** Type a NVR name to distinguish its location when you have several NVR's on a Network.
3. **KEY TONE:** By default, the NVR emits a beep every time a button is pressed. Set the key tone to OFF to turn the button beep off. By default it's "ON"
4. **AUTO LOGOUT:** You can configure the NVR to automatically log users out. By default it's "OFF". [OFF → 1 Minute → **3 Minute**→ 5 Minute→ 10 Minute]
5. **S.M.A.R.T. CHECK:** Turn ON or OFF to display HDD information in the SMART STATUS tab of the DISK menu.

## 8.2. TIME

Make sure to set up your Date and Time before starting to Record.



1. Use Left/Right buttons [◀▶] to select on “Time” menu tab. The menus are displayed with options in the left-hand column and settings in the right hand column. A cursor (highlighted menu) can be moved using the directional buttons [▲▼◀▶]. Press the [-, +] buttons to change the values.

**1) Time Zone:** Refer to <Appendix 1: Time Zone Chart>

Selects the time zone where the NVR is located. Time Zone contains DST (Daylight Saving Time) ON. If you choose Time Zone with DST, there is no change in the system time stamp for recorded data. When the Daylight Saving End date and time occurs the NVR’s time goes back one hour.

**2) Date Format:** Select Date display format.

[ MM/DD/YYYY → DD/MM/YYYY → YYYY/MM/DD ]

**3) NTP SYNC:** The internal time of NVR can be synchronised with an external time source using NTP (Network Time Server) Configuration. If the NTP option is ON, the DATE and Time option is inactivate.

**4) NTP Server:** Allows you to use a public or private NTP server. Enter the IP address of the server or domain. The default setting is public “pool.ntp.org”.

<Note> Time Sync. Interval: Min 64 sec. Max 1024 sec.

**5) NTP TEST:** Test whether NTP Server works or fails.

**6) Date & Time:** Set current time and date.

2. Save changes and exit the menu, press the [MENU] button.

Exit the menu without making changes, press the [ESC] button.

## 8.3. ACCOUNT

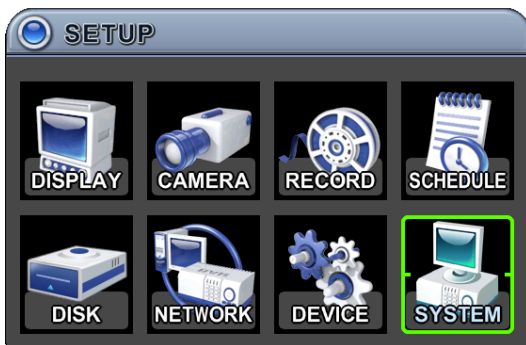

1. Use the Left/Right buttons [◀▶] to select “Account” menu tab. The menus are displayed with options in the left-hand column and settings in the right hand column. A cursor (highlighted menu) can be moved using the directional buttons [▲▼◀▶]. Press [-, +] buttons to change the values.

- 1) **User/Name:** The NVR comes preconfigured with ADMIN. Select a User 1~10, and then activate it by setting to **ON**.
  - a. Name Length: up to 10 characters.
  - b. Characters: A to Z, numerals 0 to 9.
- 2) **Privilege:** Admin can define each user’s Privilege, such as PLAYBACK, PTZ CONTROL, BACKUP, CONFIGURATION (except for Disk and System), RECORD STOP, and SYSTEM SHUTDOWN.



- 3) **Network PASSWORD:** The NVR comes preconfigured with a System Password for Network access for Admin and/or Deny for User. It is possible to create different passwords for Network access; choose using [Custom P/W].
  - a. Password Length: up to 14characters.
  - b. Characters: A to Z, numerals 0 to 9.

---

**4) Usable Channel**

Allow each user different live channels for monitoring.

**5) Password**

Enter the 6 characters for the new password, and then re-enter the same password under the CONFIRM section. An asterisk is displayed for each character entered.

2. Save changes and exit the menu, press the [MENU] button.

Exit the menu without making changes, press the [ESC] button.

## 8.4. UPDATE



1. Download the latest firmware file and copy to USB Flash memory stick in the **Root** directory.

**<NOTE >** Please make sure you download all of files below (20M).  
hd4k\_all.00.00.00.img

2. Connect or insert into Front USB (please stop recording first).
3. Use directional buttons to move to the [Start] button. Press the **[+]** button to find upgrade files. If the NVR finds a valid upgrade file, the update menu is activated.
4. Press the **[-, +]** buttons to find correct upgrade file. Version information is displayed. If there are several valid update files, please check the display for the correct one.



5. Use the directional buttons to move to the [Start] button, then press **[OK]** button to start updating. While updating, an "in progress #%" message is displayed.
6. After the update process is complete, a "Success" message is displayed. Press the **[OK]** button to restart. The NVR issues a single beep, if Micom update is included.

**NOTE 1** Do not switch OFF or PRESS any key during the update process.  
**NOTE 2** Please consult your distributor or installer before update this.

## 8.5. INFO

Press [info] button on IR remote or select  icon on the menu. The system information is displayed.



The INFO window displays system information under the SUMMARY tab. The data is as follows:

Item	Value
MODEL BRIEF	Standard PSE NVR 8ch
HOSTNAME	G5837A0
MAC	00:02:F1:58:37:A0
LANGUAGE	ENGLISH
NETWORK	192.168.6.100:7000
RECORD DISK	0M
DISK SUMMARY	0 STREAM
VERSION	D802E1-R2907

**SUMMARY :** It contains brief model information, Mac Address and installed HDD status



The INFO window displays disk information under the DISK tab. The data is as follows:

DISK ORDER	A / F	B / G	C / H	D / I	E / J
INTERNAL SATA					
EXTERNAL SATA 1					
FRONT USB					
REAR USB					

**DISK :** It contains all DISK information including internal & external HDDs and USB memory.

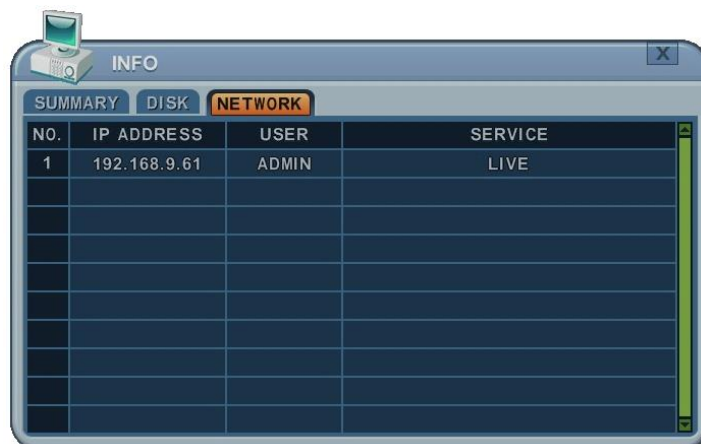

The INFO window displays network information under the NETWORK tab. The data is as follows:

NO.	IP ADDRESS	USER	SERVICE
1	192.168.9.61	ADMIN	LIVE

**NETWORK :** It shows IP address , USER and service of NET user.



# VII. PAN/TILT ZOOM CONTROL

PTZ control is available for supported third-party dome cameras. The PTZ option must be configured for each camera channel. For PTZ setup, refer to Camera Setup> **PTZ setup**.







The layout of the PTZ interface conforms to the layout of the front of the NVR or the remote controller. Menu button is the guide anchor position for all other buttons. When in PTZ interface mode, all buttons are used for the PTZ related operation.

## 1. P.T.Z. Menu

- 1) To activate the Pan/Tilt Control, select the full screen display of the camera you wish to control.
- 2) Then press the **[P/T/Z/FOCUS]** button. A shortcut Menu box pops up, as shown below.



**<Note >** Please Refer to the **Help Menu** for specific

INDICATOR	ACTIONS
 [OK] [ESC]	<ul style="list-style-type: none"> <li>Press this button to display “<b>HELP</b>” Menu. Press <b>[OK]</b> Button again, or <b>[ESC]</b> button to cancel Help Menu.</li> </ul> <div style="text-align: center;">  </div> <ul style="list-style-type: none"> <li>Press this button to cancel “<b>PAN/TITL</b>” Operation.</li> </ul>
 [MENU] Button	<ul style="list-style-type: none"> <li>PTZ camera control interface is extended to use all functions. Press this button again to go to the short-cut menu.</li> </ul> <div style="text-align: center;">  </div>
	<ul style="list-style-type: none"> <li>To Tilt Up and Down.</li> </ul>
	<ul style="list-style-type: none"> <li>To Pan Right and Left.</li> </ul>
	<ul style="list-style-type: none"> <li>Zoom In and Out.</li> </ul>

---

## 1.1 How to Control PTZ Using a Mouse

Users can control PTZ camera using the mouse controller.

It follows the mouse cursor instead of using the directional button to move.

- 1) Press the PTZ icon in the menu or press button in the remote control.
- 2) PTZ menu and control box is displayed like the picture shown below.
- 3) Place the mouse cursor inside the rectangle boundary. Move the mouse cursor, while pressing the left mouse button, in the direction you want to go.





- 4) Press the  menu button to display the virtual PTZ controller. Zoom In/Out, Go To, Tour and other functions can be controlled using the virtual PTZ controller.

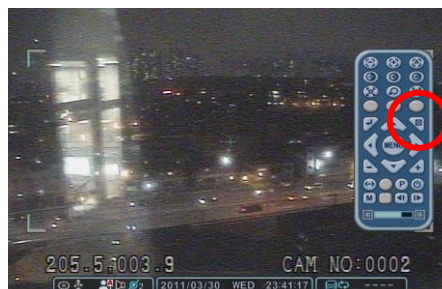

- 5) To escape from PTZ mode, press the ESC button on the PTZ controller. Or click right button, outside the control box, to return to the virtual remote controller. Then click the ESC button.



## 2. Preset & Tour

Button	Function
	Set preset position; SPOT OUT on remote controller Move the PTZ into the desired location. Press the Preset button. Custom 1 illuminates. Set the # for the Preset location. Press OK to save and exit.
	Go to preset position; INFO on remote controller Press Go to button. Enter the desired Preset # and press OK.
	Start Auto Tour; BACKUP on remote controller Press Auto Tour Button. Press the + button and enter the range of Preset and press OK.

### 2.1 Tour Group

A preset Tour Group allows a camera to move through a programmed sequence of PTZ presets.

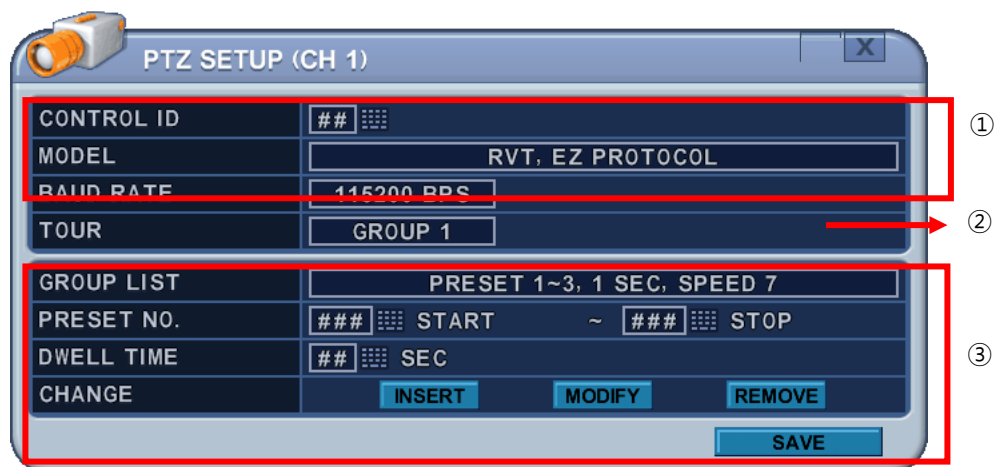



#### 1) Communication settings.



:Configure appropriate model and then select the corresponding baud rate, PTZ ID (address). Please refer to the PTZ manufacturer's instruction manual for proper jumper settings to match the protocol settings to the NVR.

- 2) **Tour:** There are 4 programmable Tours. Use the [-, +] buttons to change the values [Group 1 → Group 2 → Group 3 → Group 4]
- 3) There is sub menu of each Tour group. The menus are displayed with options in the left-hand column and settings in the right hand column.
- Group List:** Each Tour Group can consist of up to 10 preset positions.
  - Preset no. :** Enter the start preset no and stop preset.
  - Dwell Time:** Set the pause between end of current preset and the start of the next preset.
  - Change:** Add, modify or clear the Tour list using this option.
  - Repeat the procedure in **step b to d** to add Tour list.

### 3. Custom Functions

Button	Function
	PTZ custom function 1; DISPLAY on remote controller
	PTZ custom function 2; ZOOM on remote controller
	PTZ custom function 3; P/T/Z on remote controller

### 4. Auto Pan / Auto Tilt / Power

Button	Function
	Auto Pan; STOP on remote controller
	Auto Tilt; REW on remote controller
	Power On / OFF; FF on remote controller

<Note> Speed has 0~8 steps

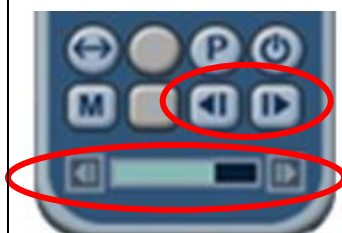

1 (Slow) – 8 (Fast)

---

# VIII.PLAYBACK /SEARCH

The NVR supports 2 playback modes; Playback and Search. The NVR offers a variety of search functions that enable you to quickly and efficiently locate and review a specific period from the database. It supports three different search modes: Date/Time, Event, Event Area and Log Search.

## 1. Playback

When the [PLAY] button is pressed, the NVR starts to play back any recorded data from the latest data, whether in live or recording mode. When the NVR reaches the end of the recorded data, it stops the playback.

During the playback, the NVR may be played back in reverse, paused, speed search up to 16 times the normal speed, or move through picture by picture.

## 2. Time Search

### 2.1 Multi Channel Playback

1. Press the  [Time Search] button to access the time search table. Day will be displayed. The data is colour-coded by category: EVENT (Red) > Normal (Yellow)

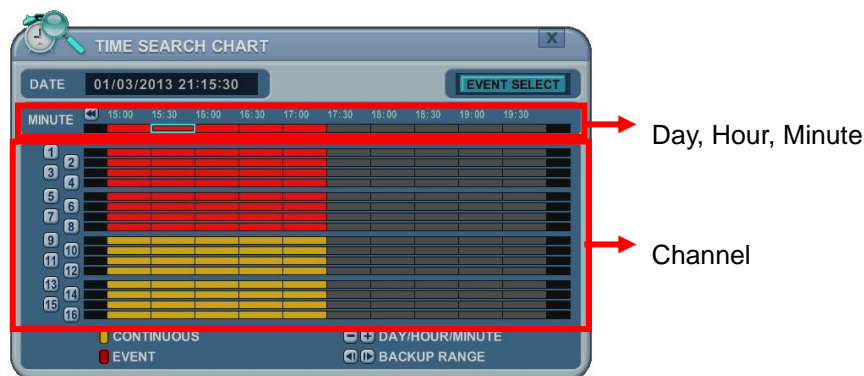

2. Use the [ + ] button to navigate to the desired **Day→Hour→Minute (5min) →Minute (30 sec)**. Use the [ - ] button to go back Minute (30sec) →Minute (5min) →Hour→Day.

When using the mouse, the wheel is used for the [ +/- ] button.

<Note> Use the [Play] button to move to the end of data

Use the [Rewind] or [Fast-forward] buttons to move to the next page.

3. To review all channels, press the [OK] button on the slot on the bar. When using

the mouse, double click.

4. The NVR starts the playback mode, displaying all channels. Any channel number or the DISPLAY button may be pressed to change the display mode.

## 2.2 Preview Search (Single Channel Playback)

The NVR allows you to quickly review a single channel of playback over a period of Day, Hour, and Minute.

1. Press the  **[Time Search]** button to access the time search table. Day will be displayed.

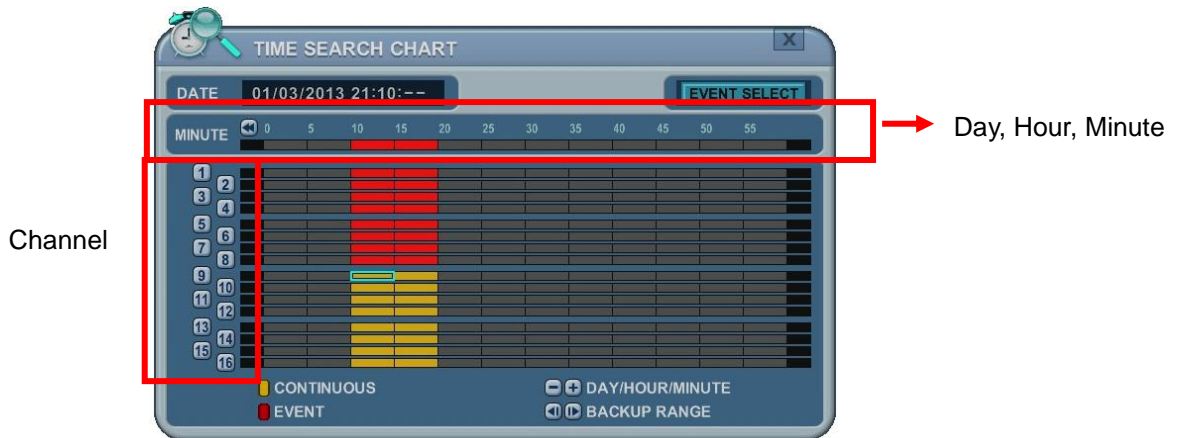

2. Choose the desired channel to review by pressing a numeric button or Click Channel number on the left.

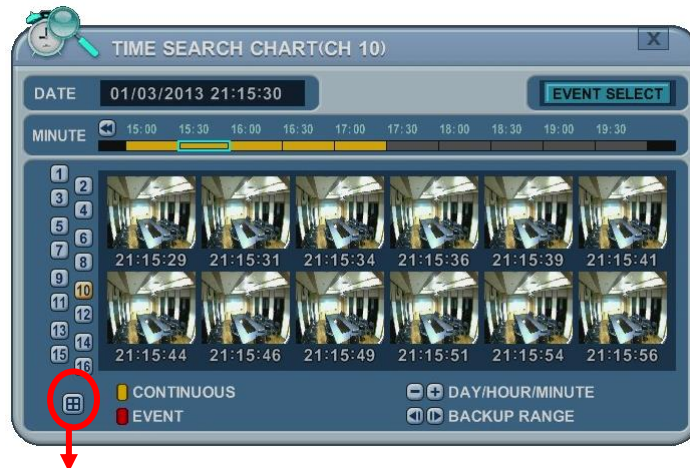

3. Use the **[+]** button to navigate to the desired **Day→Hour→Minute (5min) →Minute (30sec)**. Use the **[-]** button to go back Minute (30sec) →Minute (5min) →Hour→Day. When using the mouse, the wheel is used for **[+/-]** button.
4. While reviewing snapshot, use numeric buttons to review other channel.



5. Use the directional button to select snapshot and, press the **[OK]** button. Using mouse, double click.
6. The NVR starts the playback mode, displaying the selected channel. Any channel number, or the DISPLAY button, can be pressed to change the display mode.

### 2.3 Event Record Search

Event Record search feature allows you to search for recorded video by event. The time search table displays time events. As a default, the TIME SEARCH CHART displays CONTINUOUS recording (Yellow) and EVENT recording (Red). TIME SEARCH CHART displays different outcomes according to the SEARCH MODE below.

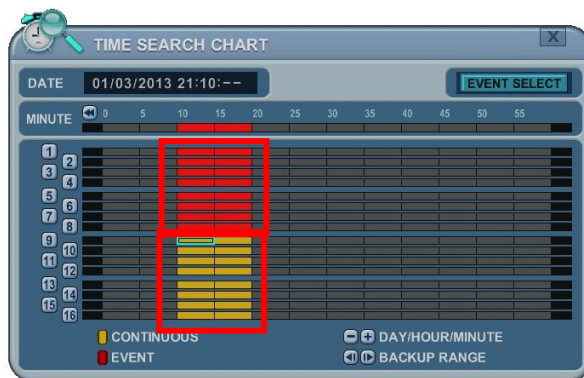

[FIGURE 1]

1. Press the “Event Select “ button to change search mode.

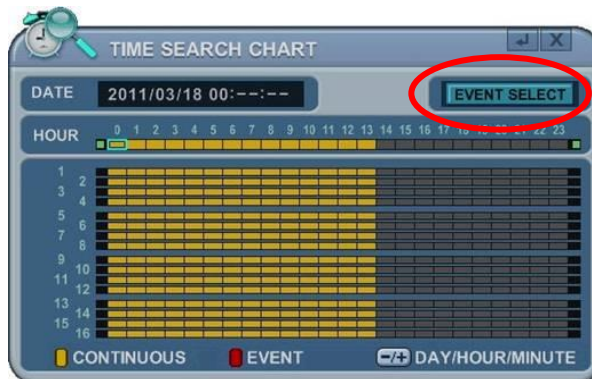

2. Press [OK] to set up. Press [+/-] button to select “event record”.



- Press [+/-] button to select "SEARCH MODE "(Event Source /Motion Area).  
By selecting Search Mode, TIME SEARCH CHART displays different outcomes.

**<Note> EVENT RECORD is set by default and makes the TIME SEARCH CHART display EVENT recording in Red as above FIGURE 1.**

## 2.4 Event Source Search

Event source search feature allows you to search the recording data for ALARM, MOTION and VLOSS events previously triggered on the NVR.

- Press [+/-] button to select "Event Source" in search mode.  
And select the event source (Alarm, Motion, Vloss) which you want to search.



- ALARM: Select Alarm Input 1~4.
- MOTION: Select the channel 1~16.
- VLOSS (Video Loss): Select the channel 1~16.
- SYSTEM: Inactivated

- Users can have multiple selections by pressing  icon, as shown below.

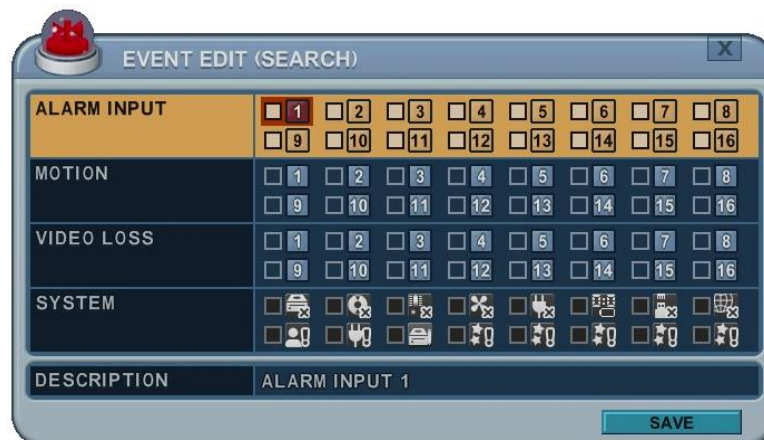



## 2.5 Motion Area Search (Single Channel Playback)

The NVR searches for recorded video that matches the search area defined by selected cells.

1. Select “MOTION AREA” (single channel playback) to search the recording data that has motion in a specific area on a certain channel.

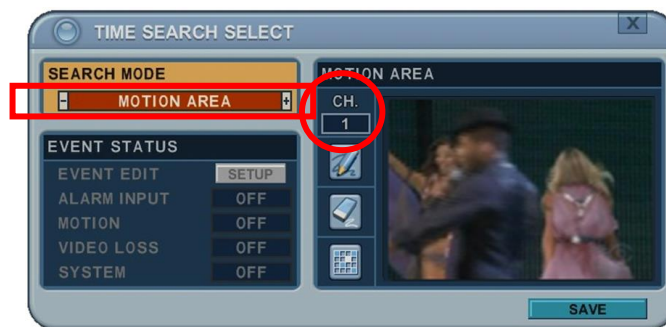

2. Press the [+/-] button to select the channel you want to search.
3. Select the motion area you want to search.

 : Select all grids

 : Deselect all grids

 : Select grids, one by one, by pressing the [+/- ] button

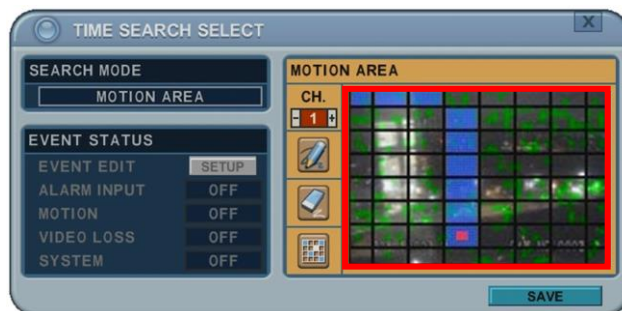

4. Press the MENU button and the TIME SEARCH CHART displays recording data, in red, to show what's happened on that channel.

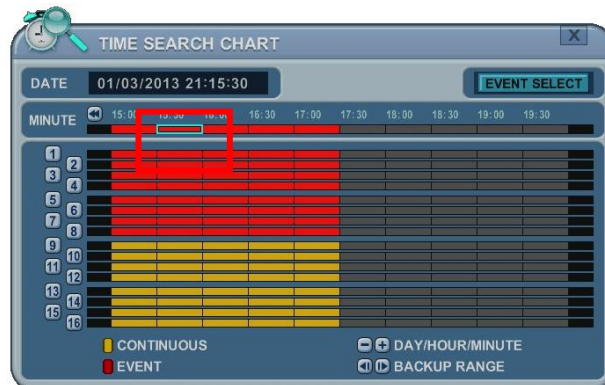

---

### 3. Go to Search



1. Press the [Time Search] button for 2 second and the [Time Input] menu pops up.
2. Set the date and time you wish to search.
3. Press [OK] or [Menu] to start searching.

## 4. Log List Search

The logs can be used to search, and to review, any point in time of the recorded data. Alarm, Motion, Video Loss and system related logs can be searched and played back directly from the time of the incident.

1. To start an Event Search, press the  [Log] button on the IR Remote and the Log List Menu pops up, as shown below.



MENU TAB	CONDITION
ALL	• A list of all events since the initial NVR power on procedure.
SYSTEM	• Shows the System List.
NETWORK	• Shows the NETWORK List.
EVENT	• Shows the Events List.
VIDEO LOSS	• Shows Video Loss List.

2. Use the Up/Down buttons [▼▲] to the desired "Time" to playback. Use the Left/Right buttons [◀▶] to move to the NEXT page.
3. Press the [OK] button to start playback.

**<Note>** 1) Log list is saved on HDD.

2) For more detailed information press 

---

# IX.BACKUP

## 1. Manual Back Up

### 1.1 External DVD- R/W

15. External USB-HDD, CD/DVD-RW is recognized within 10 seconds after plug in UBS connection cable to UBS port in DVR.

1. Plug in USB connector into the USB connection port on the front panel.
2. Press [BACKUP] button to display the backup menu.



1. Use the [-, +] buttons to change device selection: USB CD/DVD RW
2. Use the [-, +] button to select a channel. All channels are set by default.
3. Select the data for BACKUP.
  - (1) ALL Data: Normal Recording Data
  - (2) Event Only: Event Recording Data.
4. File format when saving is “.s” AVI is not supported for CD/DVD
5. Select the time range starting time and ending time.
6. Enter the numbers as required in 24-hour format, then move to **START**.
7. Press the [+ ] button to start BACKUP..

16. The progress of the backup is displayed at the bottom of the window as a percentage of the entire backup process. The OSD disappears by pressing cancel button. However, pressing the Backup button again will show the Backup status. It is recommended that playback is not performed while the NVR is in a backup session..

8. When finished, the media is ejected.

17. If there is not enough space on the media the NVR automatically ejects the disk when it's full and resume the process once new media is inserted into the drive.

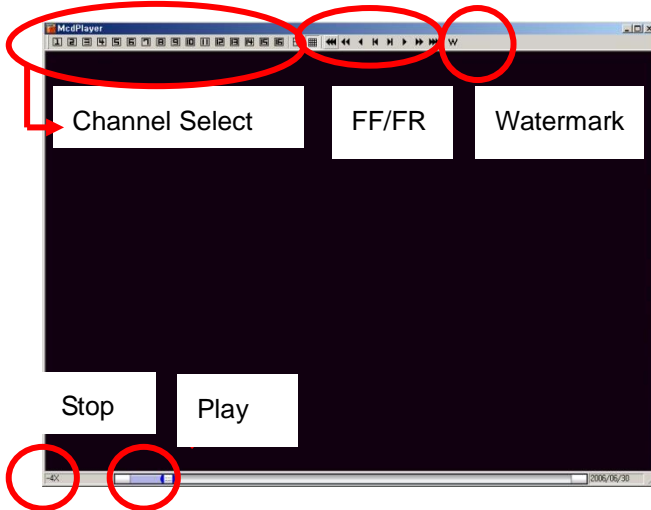

\* The CD Playback software will simply “**auto-run**” and does not require any software installation on your PC.

<Note> Please Refer to [LOCAL PLAYER] section to read about back-up devices.

<Note 2> When you back up as Multi-Section the Play List pops up instead of Auto Run.

SERIAL	BACKUP TIME	CLIP TIME
W180288	2006/07/01 15:57:02	2006/06/30 18:25:00
W180288	2006/07/01 16:00:09	2006/06/30 19:00:00
W180288	2006/07/01 16:01:57	2006/06/30 19:05:00

---

## 1.2 External USB HDD/ Memory Stick

The external drive procedure is the same as using the internal CD/DVD-RW for backup.

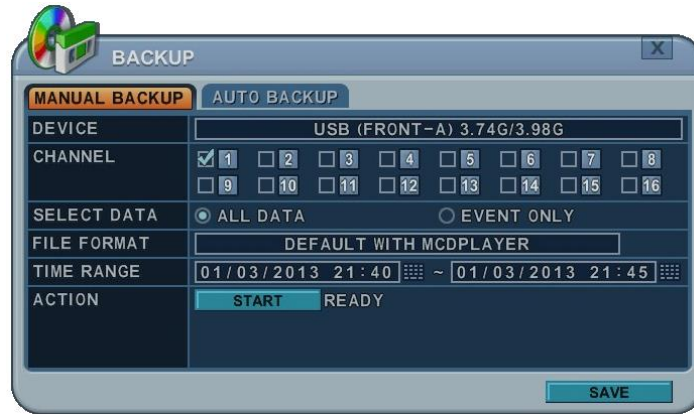

To read USB backup HDD in Window, format to FAT32 or NTFS.

To backup as an AVI File, set the file format to AVI using the [+] button.

## 1.3 Back up Range Setup

Press the [**◀**] button to set backup start time and press the [**▶**] button to set the end. Selected time changes to a Violet colour.

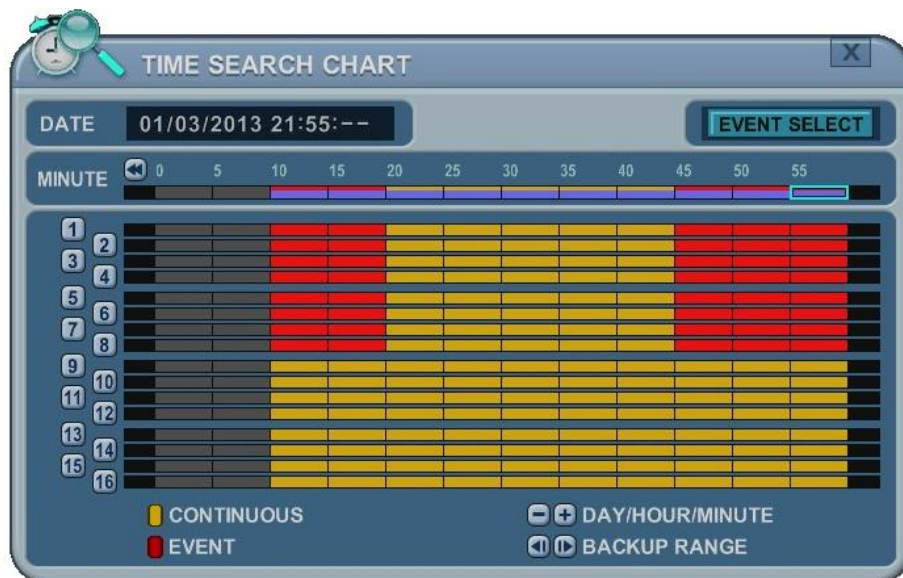

Selected backup time is displayed on the backup range.

[LOG IN/OUT] button is toggled for the range.

## 2. Auto Back Up (FTP)

1. Use the [-, +] button to change the selected device to FTP



2. Use the directional buttons to move to FTP Setup. The menus are displayed with options in the left-hand column and settings in the right hand column.



ITEM	ADJUSTMENT
Server	• Select Highlight FTP Server and then press numeric buttons to define an FTP server.
Port	• Define the port that the FTP server will communicate through.
User ID	• Enter the user ID of FTP Server.
Password	• Enter the password.
Connection	• Select PASSIVE mode or REGULAR Mode.
BACKUP PATH	• The path should be made in the FTP server in advance. Mac address is set with the default in consideration of the scenario where lots of NVR's backup files to the same FTP server.

**<Note>** Please Refer to [LOCAL PLAYER]/ [Mini-Player] section to read about back-up file



### 3. Log List Back Up

- 1 . Plug the USB memory stick into the USB port.
- 2 . Press the “Log” button to see the NVR Log List.  
( Click Log icon on the upper left by mouse)



The screenshot shows a window titled "LOG" with a USB icon in the top-left corner. The window has tabs for "ALL", "SYSTEM", "NETWORK", "EVENT", and "VLOSS". Below the tabs is a table with columns for "DATE", "TIME", "MESSAGE", and "PAGE-1". The table contains several rows of log entries, with the entry "01/03/2013 21:49:07 MANUAL BACKUP START (ADMIN)" highlighted in yellow.

DATE	TIME	MESSAGE	PAGE-1
01/03/2013	21:49:52	SNAPSHOT (192.168.9.61 ADMIN)	
01/03/2013	21:49:27	MANUAL BACKUP STOP (ADMIN)	
01/03/2013	21:49:07	MANUAL BACKUP START (ADMIN)	
01/03/2013	21:48:53	MANUAL BACKUP COMPLETE (ADMIN)	
01/03/2013	21:48:31	MANUAL BACKUP START (ADMIN)	
01/03/2013	21:48:03	MANUAL BACKUP FAIL (ADMIN)	
01/03/2013	21:48:02	MANUAL BACKUP START (ADMIN)	
01/03/2013	21:47:35	EXTERNAL DEVICE ADD (USBF-A)	
01/03/2013	21:47:10	EVENT MULTI CH (MOTION CH 1)	
01/03/2013	21:37:03	DISCONNECT (192.168.9.61)	
01/03/2013	21:36:43	SNAPSHOT (192.168.9.61 ADMIN)	
01/03/2013	21:34:05	DISCONNECT (192.168.9.61)	

- 3 . Press the “back up” button to save the log list to USB memory stick.
  - 1) Use the [-, +] buttons to select a device.
  - 2) Select type of Log List from ALL, SYSTEM, NETWORK, EVENT and VLOSS.
  - 3) Select the time range - start and end time.
  - 4) Press the [+ ] button to start the BACKUP.

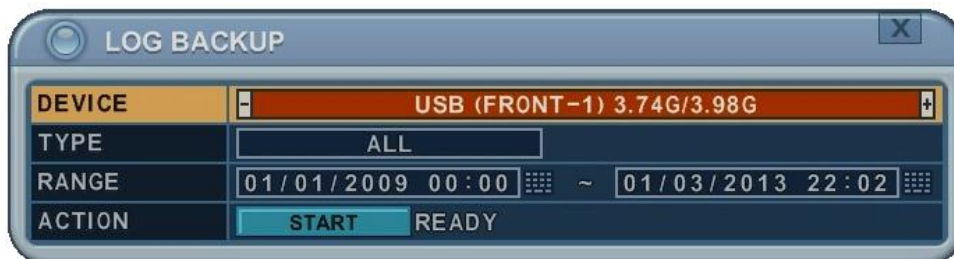

The screenshot shows a window titled "LOG BACKUP" with a USB icon in the top-left corner. The window contains a form with the following fields:

DEVICE	USB (FRONT-1) 3.74G/3.98G
TYPE	ALL
RANGE	01/01/2009 00:00 ~ 01/03/2013 22:02
ACTION	START READY



---

# X.CLIENT

All Client S.W is dedicated client program that connects and manages in real time.

Please refer to each S.W manual for more information.

1. Web server: Using Internet Explorer
2. CMS Lite: 1:1 Management S.W on the Window
3. EMS2.0 Lite: Management S.W that allows you to view and manage up to 300 DVRs.
4. iSMS: 1:1 Management S.W On the Mac
5. SMART Phone: Touch CMS lite/Pro for i phone, Android,  
MobileCMS for Blackberry

# XI.SPECIFICATION

Model No.	PNR - HD4000 Series		
	HD4004P	HD4008P	HD4K
<b>SYSTEM</b>			
Video System	NTSC / PAL (IP)		
IP Camera	4ch PoE	8ch PoE	W/O PoE
IP Resolution	D1, 720p, 1080p		
Video Output	VGA/HDMI (upto 1920x1080p)		
Audio Input / Output	1 (RCA) / 1 (RCA)		
Audio Input Level	0.5~1.4 Vp-p @ 20K Ohm		
Sensor Input / Output	4 input / 1 relay output		
External / USB Port	RS-232 / RS485 , 2 Ports (Front / Rear)		
Controller	USB mouse / IR Remote		
<b>LIVE</b>			
Display Rate	Real Time 1080p@30( 1ch full )*, 720p@30( 4 split mode ) , D1@30 (8split mode)		
<b>RECORDING</b>			
Video/Audio Compression	H.264 Codec		
Maximum Rate & Resolution	Max. 100/120 fps @ 1080p	Max. 200/240 fps @1080p	Max. 200/240 fps @1080p
Recording Frame Rate	1,2,3,4,5,7,10,15,30 (NTSC) / 1,2,3,4,5,8,12,25(PAL)		
Record Mode	Manual, Schedule, Event (motion/sensor)		
Quality	Super, High, Middle, Low (4levels)		
Pre/Post Recording	~5sec / ~300sec		
Watermark Proof	YES		
<b>PLAYBACK</b>			
Search Mode	Calendar, Time, Event, Thumb-nail, Instance		
Playback Speed	0.25x ~ 1x ~ 16x FF/REW, field by field		
<b>STORAGE</b>			
HDD Support	2 internal SATA HDDs bay (Up to 4TB)		
ODD Support	NO		
external Storage	e-SATA (1 port) / USB (2 port)		
Backup device	USB-DVD±RW / USB flash driver / Network		
<b>OSD</b>			
Display Division	1, 4, 6, 7, 9, 13, 16		
Title	Multi language / 12 characters		
GUI	YES		
Digital Zoom	2x, 4x, 8x, 16x		
<b>NETWORK</b>			
Multi Streaming	YES		
Network Compression	H.264 (from IP Camera)		
Network Users	1+10		
Client Software	client viewer / Windows (active-X) / mac PC / 3/4G mobile Phone		
EMS 2.0	Support		
Remote Notification Service	Email message TCP/IP, SMTP, DHCP, DDNS, uPnP		
<b>OTHER</b>			
Firmware Update	USB Flash Stick / Network		
Daylight Saving	YES		
Recovery	Auto Reboot		
Accounts	1 administrator / 20 users / user authority selectable		
Log	Event log (50000) / System log (20000)		
Watchdog	software / hardware watchdog		
Dimension	38 X 34 X 7 (cm)		
Power Source	12V 5A Adpater (set), 48V Adpater(PoE)		
Operation Environment	30 ~ 80% RH, 5°C ~ 40°C (41°F ~ 104°F)		

**Appendix 1: Time Zone Chart**

Standard Time	Time Zone
GMT+00:00	Standard
	European DST
GMT+01:00	Standard
	European DST
	Namibia DST
GMT+02:00	Standard
	Israel DST
	European DST
	Lebanon DST
	Jordan DST
	Russia DST
	Egypt DST
GMT+03:00	Standard
	Russia DST
GMT+03:30	Iran DST
GMT+04:00	Standard
	Azerbaijan DST
	Russia DST
GMT+04:30	Standard
GMT+05:00	Pakistan DST
	Russia DST
GMT+05:30	Standard
GMT+05:45	Standard
GMT+06:00	Standard
	Russia DST
GMT+06:30	Standard
GMT+07:00	Standard
	Russia DST
GMT+08:00	Standard
	Russia DST
GMT+09:00	Standard
	Russia DST
GMT+09:30	Standard
	Australia DST

GMT+10:00	Standard
	Russia DST
	Australia DST
GMT+11:00	Standard
	Russia DST
GMT+12:00	Standard
	New Zealand DST
GMT+13:00	Standard
GMT-01:00	Standard
	European DST
GMT-02:00	Standard
GMT-03:00	Standard
	Brazil DST
	European DST
GMT-04:00	Uruguay DST
	Chile DST
GMT-04:30	US DST
	Standard
GMT-05:00	Standard
	US DST
	Standard
GMT-06:00	Standard
	Mexico DST
	US DST
GMT-07:00	Standard
	Mexico DST
	US DST
GMT-08:00	Standard
	Mexico DST
	US DST
GMT-09:00	Standard
	US DST
GMT-10:00	Standard
GMT-11:00	Standard

<Memo>