

The Intelligent Surveillance Solution

NVS

User Manual (Remote)

Ver. 1.0.1.130326.00

Table of Contents

1.	Installation	7
1.1	Installation Process	7
2.	Settings	18
2.1	Camera Setup.....	18
2.1.1	Add Cameras by Camera Search.....	18
2.1.2	Add Cameras Manually	20
2.1.3	Modify Camera Information	21
2.1.4	Modify Camera Parameters	21
2.1.5	Set up Lens Settings.....	22
2.1.6	Set up 2nd Stream	23
2.1.7	View Camera Status	24
2.2	Recording & Event Setup.....	25
2.2.1	Recording Mode Setup	25
2.2.2	Recording Schedule / Event Setup	26
2.2.3	Camera Events and Responding Actions Setup	29
2.2.4	System Events and Responding Actions Setup.....	31
2.2.5	SMTP Server Setup.....	33
2.2.6	Add Event Contacts	34
2.3	RAID & File Settings	34
2.3.1	Create a RAID Volume	34
2.3.2	View RAID Volume Status.....	36
2.3.3	View Disk Drive Information	37
2.3.4	Modify RAID Volume	37
2.3.5	Delete a RAID Volume.....	40
2.3.6	Format.....	41
2.3.7	Modify the FTP Protocol Settings.....	41
2.4	Auto Backup	42
2.4.1	Set up Backup Schedule.....	42
2.4.2	Set up Backup Server	43
2.5	Network Setup.....	44
2.5.1	View Network Status.....	44
2.5.2	Network Settings.....	45
2.5.3	Auto Port-Forwarding	49
2.5.4	Network Service Setup.....	51
2.5.5	CMS Service Setup	52
2.5.6	findNVR.....	52

2.6	Management.....	53
2.6.1	View the List of Users	53
2.6.2	Create New Users.....	54
2.6.3	Modify User Information	55
2.6.4	Change a User’s Password	55
2.6.5	Delete Users	56
2.6.6	Online License Activation	56
2.6.7	Offline License Activation.....	57
2.6.8	View the Event Log	59
2.6.9	Save Unit Configuration.....	60
2.6.10	Load Unit Configuration / Default Settings	61
2.7	System	62
2.7.1	View System Information	62
2.7.2	Smart Fan Control	63
2.7.3	Buzzer Configuration.....	63
2.7.4	UPS Setup	64
2.7.5	Upgrade the System	64
2.7.6	System Date and Time Setup.....	65
2.7.7	Restart the Unit.....	66
2.7.8	Shut Down the Unit	66
3.	POS.....	68
3.1	Introduction	68
3.1.1	System Introduction	68
3.1.2	Hardware Installation – SCB-C31A.....	69
3.1.3	Software Installation – SCB-C31A.....	70
3.1.4	Connection via TCP Client.....	71
3.2	Software Setup	72
3.2.1	Activate POS License.....	72
3.2.2	NVR POS Setting	72
3.2.3	Insert POS Setting.....	73
3.2.4	Delete POS Device.....	75
3.2.5	Configure POS Setting.....	75
3.3	Tag Filter.....	75
3.3.1	Add New Tag Filter.....	75
3.3.2	Edit Tag Filter.....	78
3.3.3	Delete Tag Filter	78
3.3.4	Import/Export Tag Filter	79
3.4	POS Display Font.....	79

3.4.1	Live View.....	79
3.4.2	Remote Live Viewer	80
3.4.3	Playback.....	81
3.4.4	Playback System	82
3.5	POS Transaction Data Search	83
3.5.1	Search POS Transaction Data through Playback...	83
3.5.2	Search POS Transaction Data through Playback System	84
3.6	Playback Video with POS Data.....	84
3.6.1	Select Period by POS Search	85
3.6.2	Select Period by Data & Time through Playback...	85
3.6.3	Select Period by Data & Time through Playback System	85
3.7	Backup Video with POS Data.....	86
3.7.1	Backup through Internet Explorer.....	86
3.7.2	Backup through Playback System	87
3.7.3	Backup through Backup System	87
4.	Live view.....	88
4.1	Internet Explorer.....	88
4.1.1	Live View Control Panel	88
4.1.2	Live View Setting.....	91
4.1.3	General Setting	91
4.1.4	Stream Profile Setting	92
4.1.5	OSD (On-screen display) Setting	93
4.1.6	Monitor Display Setting	93
4.1.7	Notification	94
4.1.8	Set up Joystick Control.....	95
4.2	Remote Live Viewer Application.....	97
4.2.1	Remote Live Viewer Application Control Panel	97
4.2.2	Unit Connection Setting.....	100
4.2.3	General Setting	101
4.2.4	Camera Group Setting.....	103
4.2.5	Delete/ Rename Camera Groups.....	103
4.2.6	Stream Profile Setting	104
4.2.7	OSD (On-screen display) Setting	104
4.2.8	Monitor Display Setting	105
4.2.9	Notification	106
4.2.10	Set up Joystick Control	107

4.2.11	Set up Remote Live Viewer	108
5.	E-Map	109
5.1	Internet Explorer	109
5.1.1	E-Map Control Panel	109
5.1.2	Add Map	110
5.1.3	Edit Map	111
5.1.4	Delete Map	111
5.1.5	Add/Rotate Device Indicator	111
5.1.6	Delete Device Indicator	111
5.1.7	Layout Adjustment	112
5.1.8	Relative Configuration and Application	112
5.2	Remote Live Viewer Application	113
5.2.1	E-Map Control Panel	113
6.	Playback	114
6.1	Internet Explorer	114
6.1.1	Playback Control Panel	114
6.1.2	Search the Recorded Video	116
6.1.3	Play the Recorded Video	118
6.1.4	Intelligent Search	118
6.1.5	Recorded Video Enhancement	119
6.1.6	Save a Video	120
6.1.7	Save an Image	121
6.1.8	Print an Image	122
6.1.9	Backup the Recorded Video	123
6.2	Remote Playback System Application	125
6.2.1	Playback System Application Control Panel	125
6.2.2	Set up Unit Connections	125
6.2.3	Search the Recorded Video	126
6.2.4	Play the Recorded Video	127
6.2.5	Intelligent Search	127
6.2.6	Recorded Video Enhancement	128
6.2.7	Save a Video	129
6.2.8	Save an Image	130
6.2.9	Print an Image	130
6.2.10	Backup the Recorded Video	131
7.	Backup and Delete Records	132
7.1	The Backup System Application	132
7.2	Backup the Recorded Video through Windows Explorer	134

7.3	Backup the Recorded Video through FTP	135
7.4	Playback the Backup Records.....	135
7.4.1	With Playback Application.....	135
7.4.2	Without Playback Application	135
7.5	Delete the Recorded Video.....	135
7.5.1	With Backup Application	135
7.5.2	Without Backup Application	138
8.	Verification Tool.....	139
8.1	Execute Verification Tool.....	139
8.2	Verify Image / Video	140
9.	External Storage	141
9.1	Create a Volume on DAS	141
9.2	Create an External Storage.....	141
10.	Log out	143
11.	Remote PC System Requirements.....	144
12.	Troubleshooting	145
12.1	Replace a Failed Disk Drive.....	145
12.2	Respond to a Critical RAID Volume	145
12.3	Respond to a File System Error RAID Volume.....	145
12.4	Restore the Default Administrator's Password	145
12.5	Restore All Default Configuration.....	146
12.6	Install ActiveX	146
12.7	Cannot Log in to the Unit with Internet Explorer	147
Appendix – RAID System.....		148
Introduction to RAID		148
RAID 0 – Stripe		148
RAID 1 – Mirror		149
RAID 5 – Block Striping with Distributed Parity		150
RAID 10 – Mirror / Stripe.....		150
Choosing a RAID Level		151

GNU General Public License

This product includes copyrighted third-party software licensed under the terms of the GNU General Public License. Please see the GNU General Public License (GPL) for the exact terms and conditions of this license at **www.gnu.org**.

Subject to GPL, you may re-use, re-distribute and modify the GPL source code.

Note that with respect solely to the GPL Software, no warranty is provided. We do not offer direct support for the distribution.

1. Installation

1.1 Installation Process

Step 1: Unpack the Unit

This package contains the following items:

- The unit
- IR remote control, 1.5M IR extender cable
- Two type of screws for 2.5"/3.5" disk drives, SATA cable
- [Horizontal] foot pads
- 12V 4A 48W power adapter, power cord
- Quick Start Guide, CD with **Install Wizard**, **Remote Live Viewer**, **Playback System**, **Backup System**, **Verification Tool** and **Offline License Tool** application, user manual, and quick start guide



Battery spec is 1.5V, AAA, R03. Two batteries are required for a remote control.



To configure the unit, you must install the software onto a desktop/ laptop running Windows XP-SP3 32bit, Windows 7 32/64bit.

1 bay unit front view

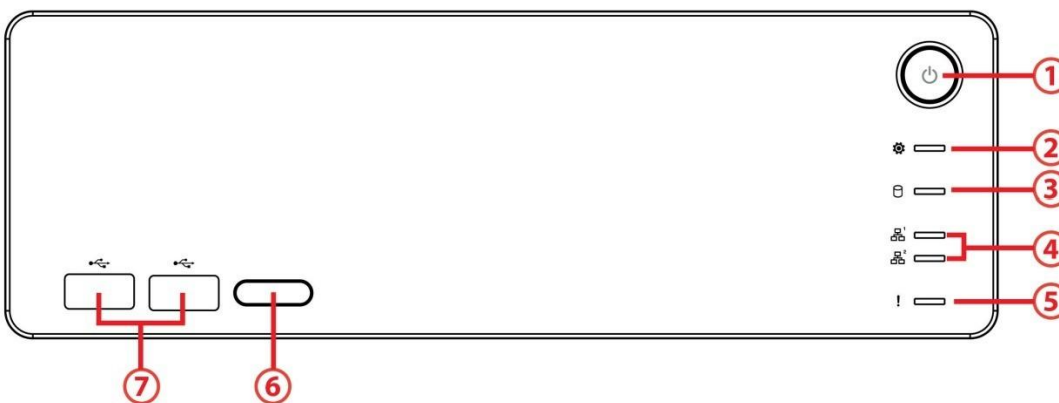

Status LED:

No.	Description	Status Notice	Remark
1	Power Status LED	<ul style="list-style-type: none"> ▶ Power-on: blue ▶ Power-off: dark 	--
2	System Status LED	<ul style="list-style-type: none"> ▶ Healthy: blue ▶ Unhealthy: orange ▶ Abnormal temperature status: orange with blinking ▶ Off: dark 	1) Orange: System is abnormal (including RAID) 2) Orange with blinking: CPU

			temperature/fan rpm is beyond the normal range 3) Blinking (200 ms On/ 200 ms Off)
3	HDD Status LED	<ul style="list-style-type: none"> ▶ Healthy: blue ▶ Failed: orange ▶ No disk: dark ▶ Rebuilding: orange with blinking 	1) LED for all disks 2) Blinking (200 ms On/ 200 ms Off)
4	Ethernet Status LED	<ul style="list-style-type: none"> ▶ Linking: blue ▶ Accessing: blue with blinking ▶ No linking: dark 	1) LED for Ethernet port (1*output for detecting connection status of switch) 2) Blinking (200 ms On/ 200 ms Off)
5	Alarm LED	<ul style="list-style-type: none"> ▶ No event happened: dark ▶ Event detected: orange with blinking 	Blinking (200 ms On/ 200 ms Off)

External Control and I/O Ports:

No.	Description
1	Power button
6	Remote control IR receiver
7	USB 2.0 connector

1 bay unit rear view

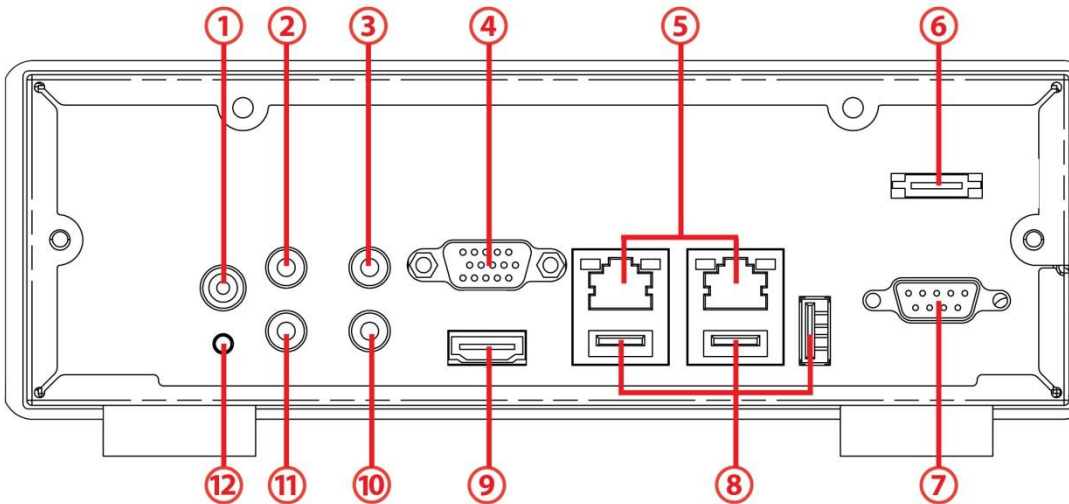

Status LED:

No.	Description	Status Notice	Remark
5	Ethernet Activity LED	<ul style="list-style-type: none"> ▶ Linking: green ▶ Accessing: green with blinking ▶ No linking: dark 	1) LED for Ethernet port 2) Blinking (200 ms On/ 200 ms Off)

External Control and I/O Ports:

No.	Description
1	DC-in power connector
2	3.5 mm mic-in (reserved)
3	3.5 mm audio out (headphone jack) (reserved)
4	VGA connector
5	RJ-45 LAN ports 1 / 2
6	eSATA connector
7	COM port (RS-232 reserved)
8	USB 2.0 connectors
9	HDMI connector
10	Connection of IR extender
11	3.5 mm line-in (reserved)
12	Reset toggle

Horizontal

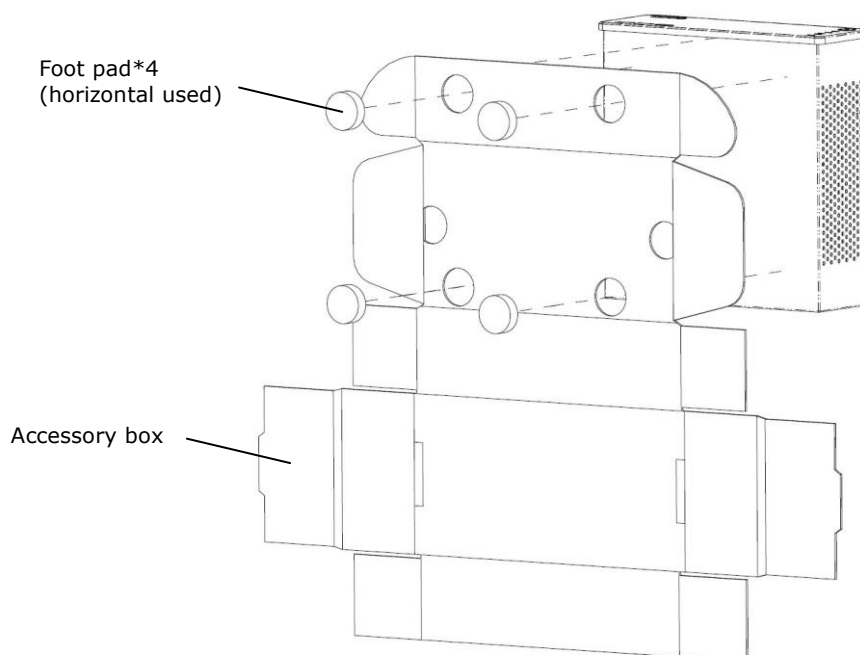

Step 2: Install Hard Drives

Refer to compatibility list and install HDDs. For optimal performance consideration, install disks with the same model and storage capacity. The available RAID level depends on the amount of disks installed.

1. Open the lid of the unit.
2. Carefully lock the disks into the HDD tray with screws. 4 screws for each disk. Lock the lid of the unit once you finished.

1 bay unit: install 3.5" HDD

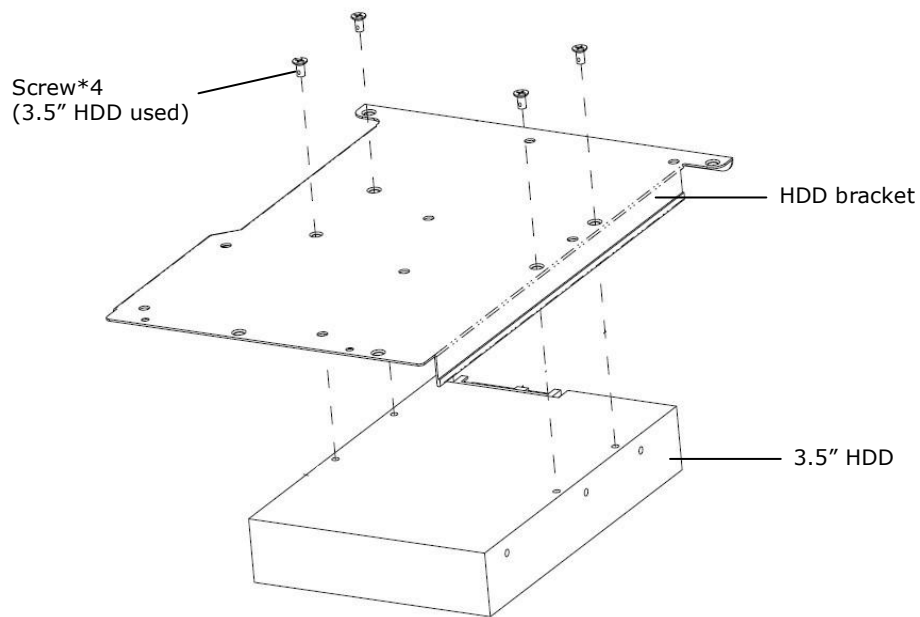

1 bay unit: install 2.5" HDD

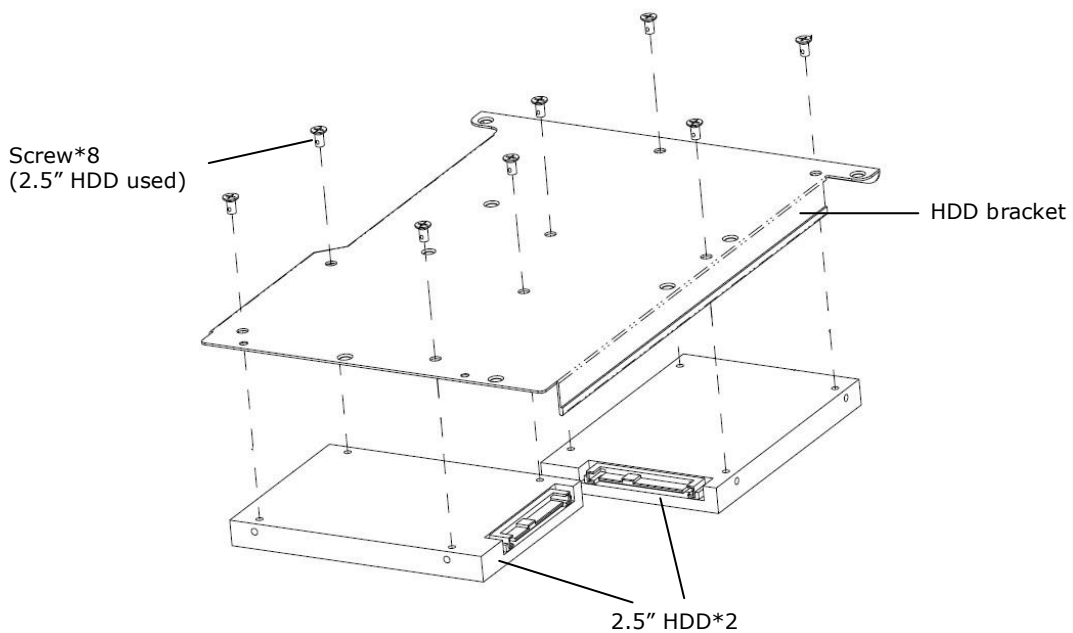

Step 3: Connect the Unit and Devices within the Network

1. Connect the unit, cameras, and router/switch.
2. If you need to make the video visible over the Internet, please connect to a "router" with Internet connection, and the unit will retrieve an IP address through DHCP by default.



The unit processes built-in DHCP service, which takes the job of router to assign IP addresses, which is suitable for the pure LAN environment.

Step 4: Connect the Monitor (Local)

1. The unit processes two display interfaces, VGA and HDMI. Connect the monitor to the unit.



The supporting display resolutions are 1920x1080, 1280x1024, 1280x720, and 1024x768. Please confirm that one of the resolutions is supported by your monitor.

Step 5: Connect the Power

1. Attach the power cord from the power source to the power adapter.
2. Connect the power adapter to the back of the unit enclosure. See the rear view figure.
3. On the front of the unit, press the power button. See the front view figure.

It takes about a minute for the unit to fully power up. Once it is powered up:

- The System Status LED turns blue. See the front view figure.
- The buzzer beeps one time.

Step 6: Install the Software

Please be noticed that you can choose to start up system on the local side or from the remote side. Here is the introduction of remote startup. If you are interested in the local part, please refer to "User Manual (Local)".

1. Insert the CD into your CDROM.
2. Double-click **Setup.exe** to begin installation.
3. Follow the instruction of **Setup.exe**, and click the **Finish** button to close the installer.

Step 7: Set up the Unit

The software **Installation Wizard** performs the setup procedures on the unit. After the procedure, you can begin using it.

1. Go to Start > NVR > NVR Install Wizard.
2. This program will show the default language setting and initiation mode.
3. Choose your preferred language and initiation mode, and then click the  button.

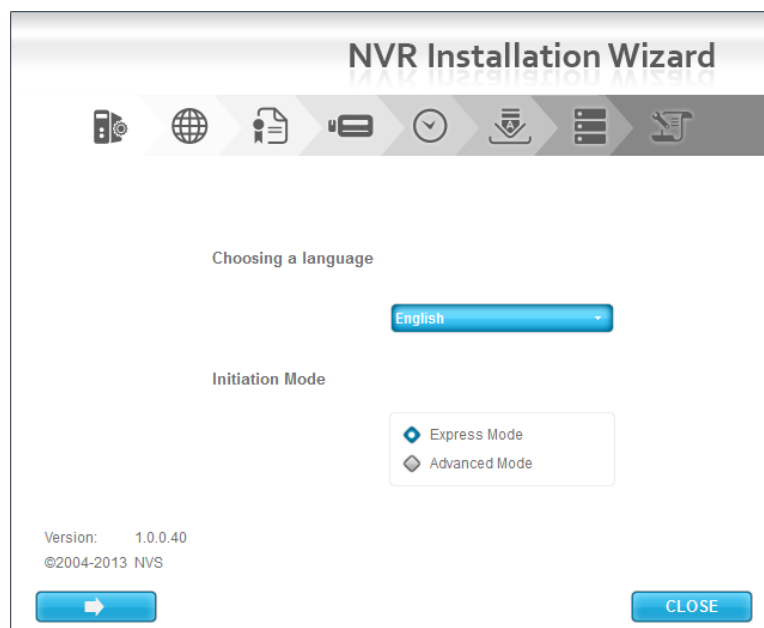



- **Express Mode**: you don't need to set up the network settings and RAID level.
 - **Advanced Mode**: configure all settings manually: network, license, camera, Date/Time, and RAID level
4. The **Installation Wizard** program starts searching for all the units on the internet currently. Choose one of them, and then click the  button.

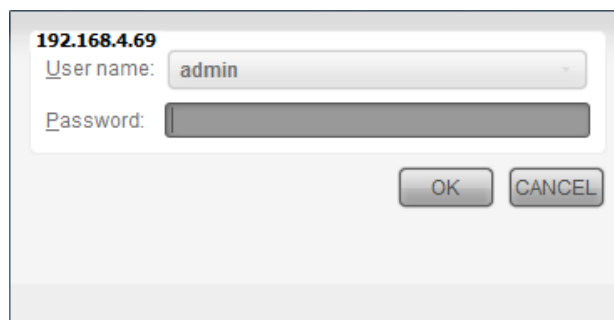

5. Type in the password, and then click the **OK** button.



 The default Administrator password is "admin".

6. Name this server and select the network type, and then click the  button.

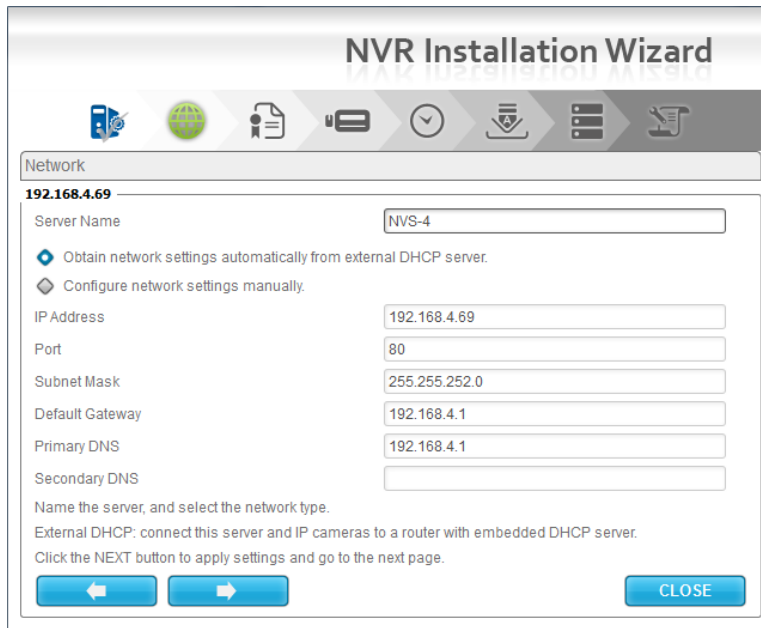

- **Obtain network settings automatically from external DHCP server:** apply all settings which are automatically generated by the DHCP server, such as IP, subnet mask, gateway, and DNS.
- **Configure network settings manually:** configure the preferred settings one by one.

7. Activate camera license to have more channel capacity, and click the  button.

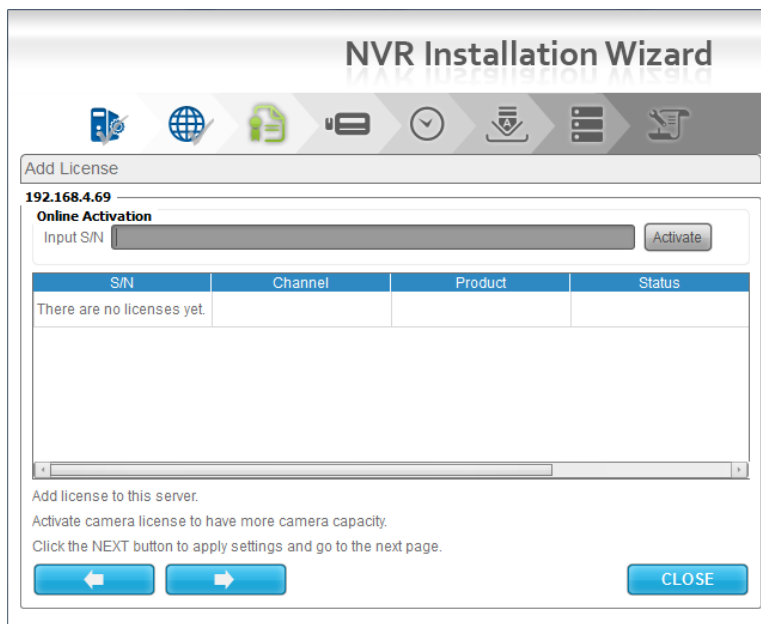

8. Add cameras for this server. There are two ways of adding cameras, selecting the searched cameras and manually configuring the cameras. Click the  button after completing camera list.

NVR Installation Wizard

Auto camera search

192.168.4.69

Selected	MAC Address	IP Address	Port	Vendor	Model	Camera Name	Video Channel	Admin

Make a camera list for this server by selecting searched cameras.
Only cameras supporting search mechanism and being equipped in subnet are searchable.
Click the NEXT button to apply settings and go to the next page.

NVR Installation Wizard

Auto camera search

192.168.4.69

Current channel capacity: 3 (Max: 4)

Selected	MAC Address	IP Address	Port	Vendor	Model	Camera Name	Video Channel	Admin
1 <input type="checkbox"/>	54-42-49-D5-EA-8B	192.168.4.88	80	Sony	SNC-CH220	<input type="text"/>	1	<input type="checkbox"/>

Make a camera list for this server by selecting searched cameras.
Only cameras supporting search mechanism and being equipped in subnet are searchable.
Click the NEXT button to apply settings and go to the next page.

NVR Installation Wizard

Manual camera setting

192.168.4.69

Camera Name	IP Address	Port	Administrator Name	Password	Vendor
1 Camera 1	192.168.4.88	80	admin	admin	Sony
2		80			-- none --
3		80			-- none --
4		80			-- none --

Make a camera list for this server by adding cameras manually.
 Click the Auto Detection button to obtain vendor/model automatically after filling in other fields.
 Click the NEXT button to apply settings and go to the next page.

- Set up the time zone, date, and time, and adjust daylight saving changes if needed. Once daylight saving function is enabled, the time change will activate automatically every year based on the recurrence you set. Click the button.

NVR Installation Wizard

Date/Time

192.168.4.69

Time Zone: (GMT+08:00) Beijing, Hong Kong, Kuala Lumpur, Perth, Singapore, Taipei, Urumqi

Date: 3/26/2013

Time: 6:29:10 PM

Adjust clock for daylight saving changes +2 hour(s) every year

Start Time: 2:00

◆ Date: 03-11 (MM-DD)

◆ Month: 1 First Sunday

End Time: 2:00

◆ Date: 11-04 (MM-DD)

◆ Month: 1 First Sunday

- Follow the following instruction and select the RAID type you want to create. Click the button.

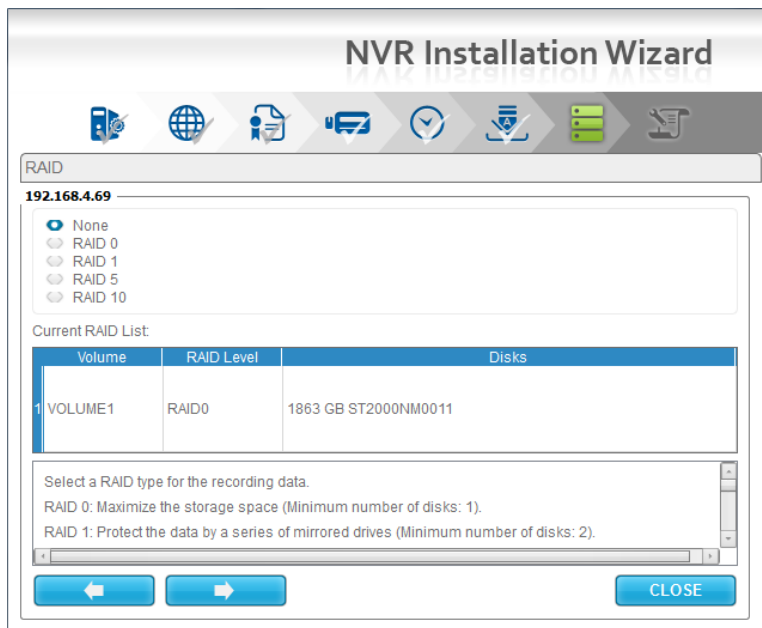

The available RAID level depends on the amount of disks installed.

11. Review your settings. If the settings are correct, click the **Finish** button to exit the settings procedure and activate the system.

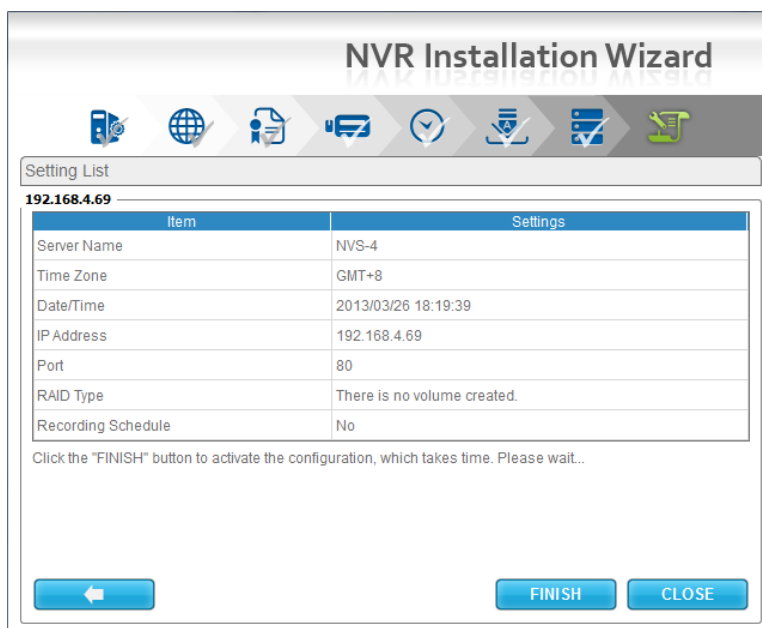

Once the "FINISH" button is clicked, the unit will start working. In order to ensure the stability of the unit, never pull any disks out when the system is running.

2.Settings

After setting up the unit, log in to the system by entering its IP address in the browser (Internet Explorer 8 and 9). When connecting, choose your language, enter the username and password, and then begin using this system.

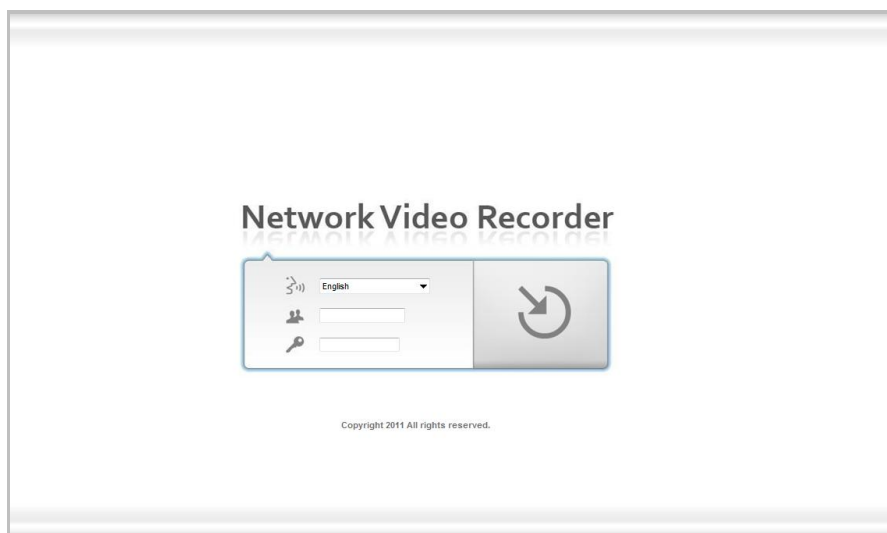

There are four main functions of this unit: settings, live view, playback, and logout. They will be shown on the top of the page. Current firmware version and free storage capacity are shown above the function list.



2.1 Camera Setup

2.1.1 Add Cameras by Camera Search

The function enables user to automatically search and add cameras in the same network. There are two search mechanisms, one is UPnP, another is camera search tool. Before searching UPnP cameras, make sure that the cameras possess UPnP function.

1. Open Internet Explorer and log in to the unit.
2. Click **IP Camera/ Camera Settings**.
3. Click the **Camera Search** tab.

4. Click the **Search** button.

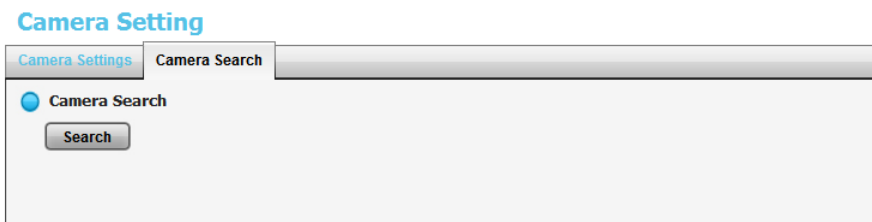

5. The system will list all the currently available cameras. The inserted cameras are shown in blue. Click the  icon to add a camera into your camera list.

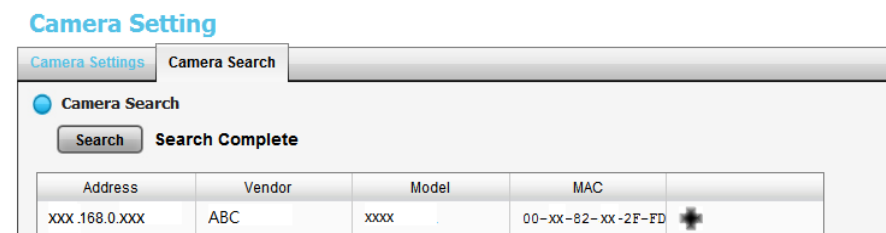

6. After clicking the  icon, the camera setting page will pop up. Click the item to which you want to add a camera.

7. Insert the camera name, username, and password.

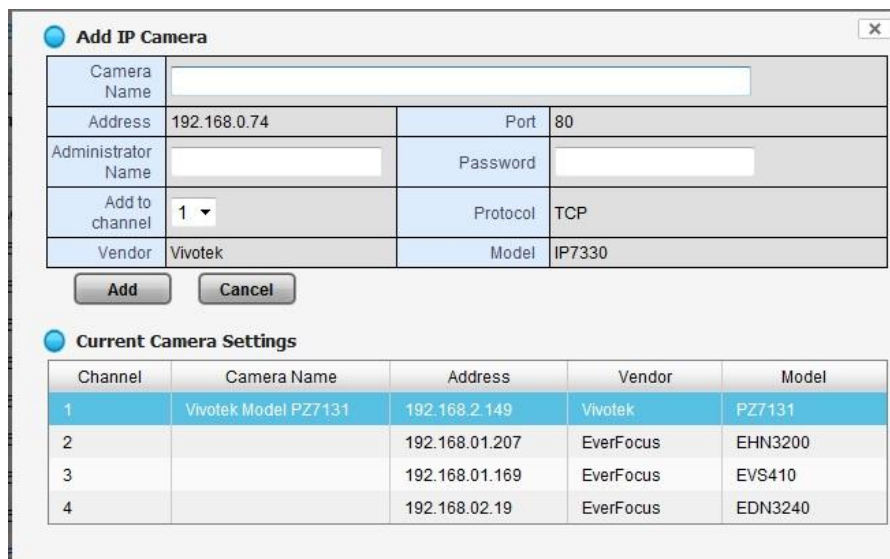

To have better compatibility between camera and system, please make sure the privilege of camera credential is admin-level.

8. Click the **Add** button to add it.

9. After clicking the **Add** button, the updated camera list will be displayed in

the **Camera Setting** tab.

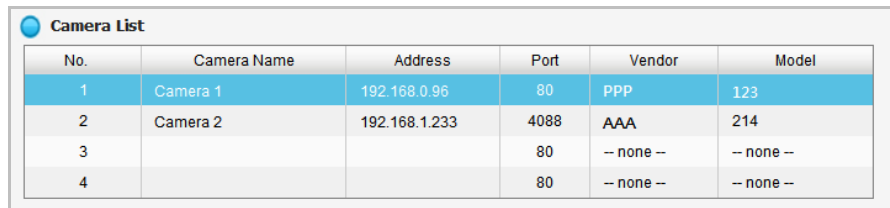

No.	Camera Name	Address	Port	Vendor	Model
1	Camera 1	192.168.0.96	80	PPP	123
2	Camera 2	192.168.1.233	4088	AAA	214
3			80	-- none --	-- none --
4			80	-- none --	-- none --

2.1.2 Add Cameras Manually

1. Open Internet Explorer and log in to the unit.
2. Click **IP Camera / Camera Settings**.
3. Click the **Camera Settings** tab, and the camera list will be displayed on the bottom of the page.
4. Click on the camera list for the channel you want to add and enter the camera's information.

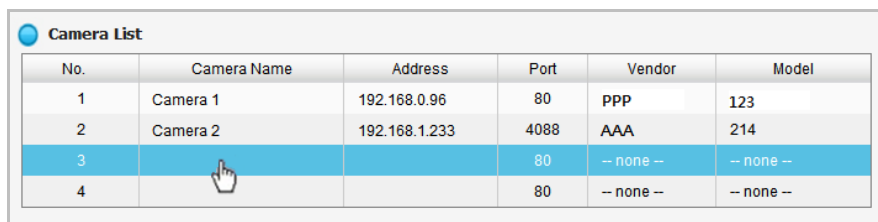

No.	Camera Name	Address	Port	Vendor	Model
1	Camera 1	192.168.0.96	80	PPP	123
2	Camera 2	192.168.1.233	4088	AAA	214
3			80	-- none --	-- none --
4			80	-- none --	-- none --

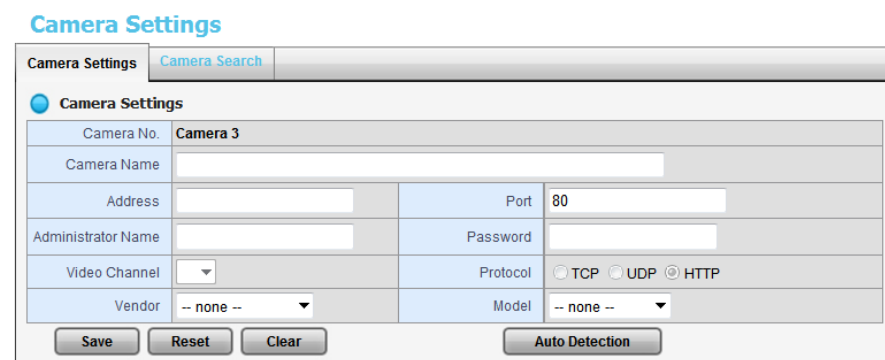

Camera Settings

Camera No. **Camera 3**

Camera Name

Address Port

Administrator Name Password

Video Channel Protocol TCP UDP HTTP

Vendor Model

- **Camera name**: The name of the camera.
- **Address**: The IP address.
- **Port**: The transmission port.
- **Administrator Name**: Login username.
- **Password**: Login password.
- **Video Channel**: Select the number of analog cameras supported by one

video server or select the number of IP cameras possessing multiple lens/channels.

- **Protocol**: Data transmission protocol.
- **Vendor**: Camera vendor name.
- **Model**: Camera model name.



To have better compatibility between camera and system, please make sure the privilege of camera credential is admin-level.

5. Click the **Save** button.

- **Save**: Save the information of this camera.
- **Reset**: Return to the latest saved settings of the selected camera.
- **Clear**: Set all the settings to default value.
- **Auto Detection**: After inserting IP address, port, username, and password, click this button to automatically detect other camera information, including Channel, Protocol, Vendor, and Model.

2.1.3 Modify Camera Information

1. Open Internet Explorer and log in to the unit.
2. Click **IP Camera / Camera Settings**.
3. Click the **Camera Settings** tab.
4. Click the camera which you want to modify.
5. Modify the information of this camera.
6. Click the **Save** button.
7. Use the same method to replace a camera if needed.

2.1.4 Modify Camera Parameters

1. Open Internet Explorer and log in to the unit.
2. Click **IP Camera / Camera Parameters**.
3. Click the **Camera Parameter** tab.
4. Click the camera which you want to modify on the camera list.
5. Modify the information of this camera.
6. Click the **Save** button.

Camera Parameter

The screenshot shows the 'Camera Parameter' configuration page with the 'Lens Settings' tab selected. The 'Camera Parameter' section is active, showing the following settings:

Camera Name	Camera 1
Video Format	<input checked="" type="radio"/> Motion JPEG <input type="radio"/> MPEG4 <input type="radio"/> H.264
Frame Rate	5
Resolution	640x480
Quality	1 Fine
Audio	<input type="checkbox"/> Enable Audio

Buttons for 'Save' and 'Reset' are located at the bottom of the form.

- **Camera Name:** The name of the camera.
- **Video Format:** Choose the type of format which this camera supports.
- **Frame rate:** Select the frame rate of the camera.
- **Resolution:** Select the resolution of the camera.
- **Quality:** Select the image quality of the camera.
- **Audio:** Check the **Enable Audio** option to view and enable audio recording.

2.1.5 Set up Lens Settings

1. Open Internet Explorer and log in to the unit.
2. Click **IP Camera / Camera Parameters**.
3. Click the **Lens Settings** tab.
4. Click the camera which you want to modify in the camera list.
5. Modify the information of this camera.
6. Click the **Save** button.

Camera Parameter

The screenshot shows the 'Camera Parameter' configuration page with the 'Lens Settings' tab selected. The 'Lens Settings' section is active, showing the following settings:

Camera Name	Location 1 (immervision lens)
Lens Type	ImmerVision IMV1-1/3
Lens	<input checked="" type="radio"/> Enable <input type="radio"/> Disable
Camera Position	Wall

A 'Save' button is located below the settings.

The 'Camera List' section shows a table with the following data:

No.	Camera Name	ImmerVision Lens	Camera Position
1	Location 1 (immervision lens)	Enable	Wall
2	Location 2	Disable	-- none --
3	Location 3 (Vivotek FE8171)	Enable	Ceiling
4		Disable	-- none --

- **Camera Name:** The name of the camera.
- **Lens Type:** There are two types of lens currently, ImmerVision and Vivotek (FE8171V). You are not allowed to select type so far, type depends on camera model.

- **Lens:** Enable or disable lens function.
- **Camera Position:** Select the position of the camera.



If users enable the lens while lens is not installed correctly or not even installed, a warning message will pop up as a notification if users are trying to operate lens on liveview page.

2.1.6 Set up 2nd Stream

Stream profile is designed for mobile client and lower fps live stream display. Without stream profile integration, users cannot watch live video on mobile client nor select lower fps stream on liveview. Further, for performance consideration, we fix the resolution and frame rate for each brand/series.

1. Open Internet Explorer and log in to the unit.
2. Click **IP Camera / Camera Parameters**.
3. Click the **2nd Stream Settings** tab.

Camera Parameter

Camera Parameter | Lens Settings | **2nd Stream Settings**

2nd Stream Settings

Channel: 1

Camera Name: Camera 1

Stream Profile: Enable Disable

Stream Profile

Low Profile

Format	MJPEG
Frame Rate	2
Resolution	CIF

Minimum Profile

Format	MJPEG
Frame Rate	1
Resolution	CIF

Camera List

Channel	Camera Name	Camera Vendor	Camera Model	Sub-Streaming
1	Camera 1	PPP	123	Disable













- **Stream Profile:** If you want mobile client user to access to this camera, you can select **Enable** (default), and click **Save** button in the middle of the page.
- **Low Profile:** The stream profile, under 300kbps, is designed for mobile client single-view.
- **Minimum Profile:** The stream profile, under 100 kbps, is designed for mobile client multi-view.

2.1.7 View Camera Status

1. Open Internet Explorer and log in to the unit.
2. Click **IP Camera / Camera Status**.

Camera Status

Camera Status







No.	Name	Address	Connection Status	Rec. Status	Frame Rate	Bit Rate
1	Location 1	192.168.4.47	 		5.0 fps	1973.5 Kbps
2	Location 2	192.168.1.106	 		0.0 fps	0.0 Kbps
3			 		0.0 fps	0.0 Kbps
4			 		0.0 fps	0.0 Kbps
						1973.5 Kbps

Estimated Remaining Recording Time: **6 day(s) 1 hour(s)**



If your total bit rate becomes **red**, it means that the system load is too heavy

Last Update at Thursday, October 04, 2012 7:55:03 PM

- **Conn. Status:** The status of the connection. Click the **Connect** or **Disconnect** button to change the connection status.

	Status	Icon
Connection Status	Connected	
Connection Status	Disconnected	
Connection Status	Connecting	
Connection Button	Connected: Normal	
	Connected: Over	
Connection Button	Disconnected: Normal	
	Disconnected: Over	

- **Rec. Status:** The set recording schedule of this camera in this time.

	Status	Icon
Recording Status	No Recording	
Recording Status	Always Recording – Recording	

Recording Status	Always Recording – Stopped	
Recording Status	Schedule Recording – Recording	
Recording Status	Schedule Recording – Stopped	

- **Frame Rate**: The frame rate of this camera.
- **Bit Rate**: The transmission bit rate of this camera.
- **Estimated Remaining Recording Time**: Estimated remaining recording time is dividing the current free capacity by dynamic total bit rate.



If your total bit rate becomes red, it means that the loading of the system is too heavy.

2.2 Recording & Event Setup

2.2.1 Recording Mode Setup

1. Open Internet Explorer and log in to the unit.
2. Click **Recording & Event / Recording settings**.
3. Click the **Recording Mode** tab.
4. If selecting **Always Record**, the chosen cameras will begin to record immediately.

Recording Settings

Recording Mode | **Recording Schedule** | Motion | Input

Recording Mode

Recording Mode

No Recording

Record by Schedule

Always Record

All Camera 1 Camera 2 Camera 3 Camera 4

Automatic Recycle Enable

Keep Video Keep Video Days

Save Reset

- **No Recording**: Turn off the recording.
- **Recording by Schedule**: Recording by schedule.
- **Always Record**: Permanently turn on the chosen cameras.
- **Automatic Recycle**: Check the **Enable** option to recycle disk space automatically when the disk space is full.

- **Keep Video**: Set a period during which the recorded video clips will be kept intact. (max: 365)



The privilege of automatically recycle is higher than keep video if you select both.

2.2.2 Recording Schedule / Event Setup

Instead of **Always Record**, you can begin the recording by setting the **Recording Schedule**.

1. Open Internet Explorer and log in to the unit.
2. Click **Recording & Event / Recording Settings**.
3. Click the **Recording Schedule** tab.
4. Check the **Day** or **Week** mode.
 - **Day**: Schedule the recording to turn the recorder on and off at the same time every day according to your setting.
 - **Week**: Schedule the recording for each day of the week differently.
5. Click the schedule of the camera which needs to be modified.
6. Click the column at the bottom of the page.

Recording Settings

Recording Mode Recording Schedule Motion Input

Recording Schedule

Day Week

Camera List

- Camera 1
- Camera 2
- Camera 3
- Camera 4

Camera	00	01	02	03	04	05	06	07	08	09	10	11	12	13	14	15	16	17	18	19	20	21	22	23	24
Cam1	Red	Red	Red	Red	Red	Red	Red	Red	Red	Red	Red	Red	Red	Red	Red	Red	Red	Red	Red	Red	Red	Red	Red	Red	Red
Cam2	Red	Red	Red	Red	Red	Red	Red	Red	Red	Red	Red	Red	Red	Red	Red	Red	Red	Red	Red	Red	Red	Red	Red	Red	Red
Cam3	Red	Red	Red	Red	Red	Red	Red	Red	Red	Red	Red	Red	Red	Red	Red	Red	Red	Red	Red	Red	Red	Red	Red	Red	Red
Cam4	Red	Red	Red	Red	Red	Red	Red	Red	Red	Red	Red	Red	Red	Red	Red	Red	Red	Red	Red	Red	Red	Red	Red	Red	Red

Insert Delete Configure Copy

Start Time	End Time	Record
00:00	24:00	Always

Save Reset

Before setting record on motion, remember to enable the motion detection function in the camera web first.

- **Insert**: Insert new schedules.
- **Delete**: Delete the selected schedule.
- **Configure**: Modify the schedule and recording mode settings.
- **Copy**: Copy current **Day Schedule** to other channel(s); copy current **Week Schedule** to other day(s) of a week or other channel(s).

Copy Day Schedule

Apply current Day Schedule to other channels

channel 1 channel 2 channel 3 channel 4

Select: all none

OK Cancel

Copy Week Schedule

Copy Current Schedule

Apply current Week Schedule to other weeks

Sunday Monday Tuesday Wednesday

Thursday Friday Saturday

Apply all Week Schedule to other channels

channel 1 channel 2 channel 3 channel 4

Select: all none

OK Cancel

7. The default setting of the camera's recording schedule is from 00:00 to 24:00. If you want to modify the time slot, click the **Configure** button to modify the default settings first.

Schedule Configuration

Time

Start Time: 00 : 00

End Time: 24 : 00

Mode

Always Record

Motion

Digital Input

OK Cancel

8. Choose the recording mode.

Schedule Configuration

Time

Start Time: 00 : 00

End Time: 24 : 00

Mode

Always Record

Motion

Digital Input

OK Cancel

- **Always Record**: Always record.
- **Motion**: Record when camera motion is detected. Go to the "Motion" tab to define which camera's motion detection to associate with this channel

of camera to start recording.

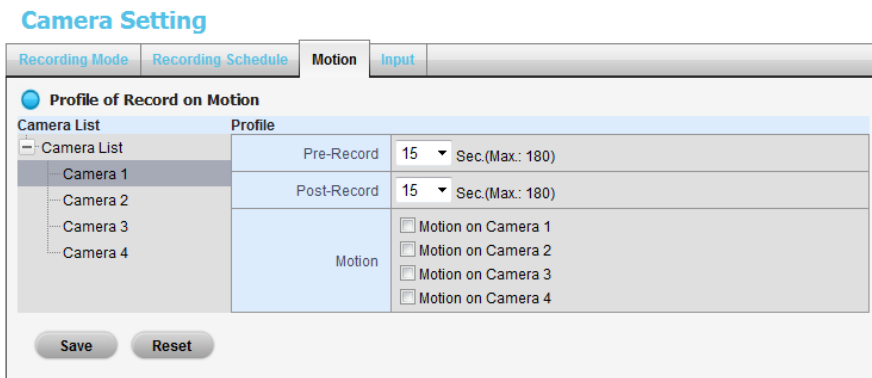

- **Digital Input:** Record when digital input is triggered. Go to the "Input" tab to define which input triggering to associate with this channel of camera to start recording.

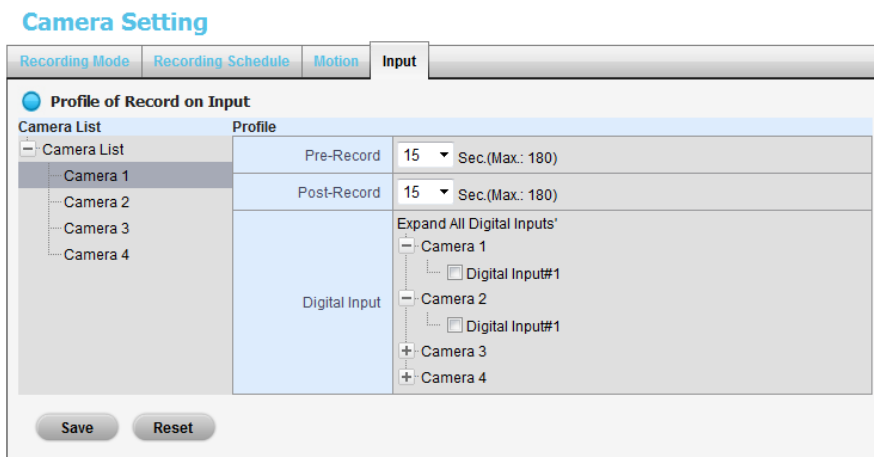

When setting the event Motion, please first ensure that the motion detection function of the camera has been enabled.

9. If you want to add another new schedule, click the **Insert** button to add a new one.

Recording Settings

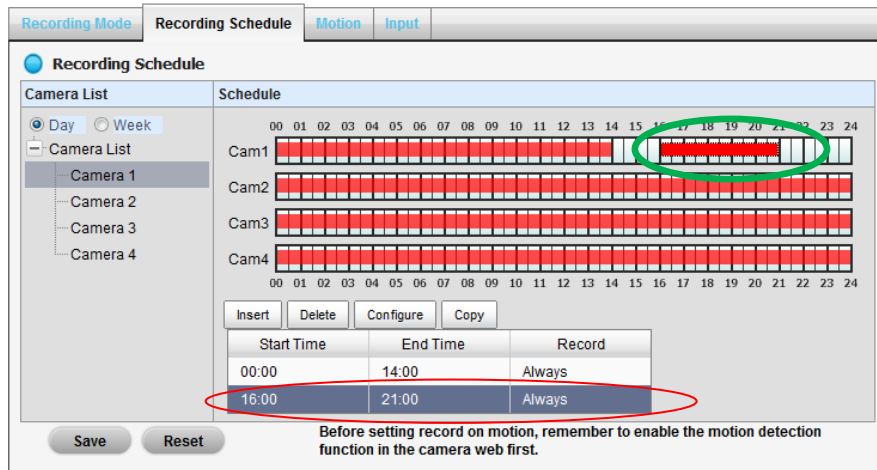

Recording Schedule

Camera List: Day (selected), Week

Cam1 Schedule: 00 01 02 03 04 05 06 07 08 09 10 11 12 13 14 15 16 17 18 19 20 21 22 23 24

Start Time	End Time	Record
00:00	14:00	Always
16:00	21:00	Always

Buttons: Insert, Delete, Configure, Copy

Buttons: Save, Reset

Before setting record on motion, remember to enable the motion detection function in the camera web first.

10. Click the **Save** button.



When changing the motion detection settings of a camera, make sure to disconnect your unit and that camera first. Once you have finished, re-connecting them will update the settings in your unit.



There is another way to set the schedule. If you want to change the recording time length, drag the end of the time bar from 24:00 back to the length you wish, and then drag the beginning of the time bar to the point at which you would like it to commence recording. (You may also click the **Insert** button to add new schedules.)

2.2.3 Camera Events and Responding Actions Setup

1. Open Internet Explorer and log in to the unit.
2. Click **Recording & Event / Event & Action Management**.
3. Choose the camera, and then select one of the events. The event list depends on camera its own ability.

Event & Action Management

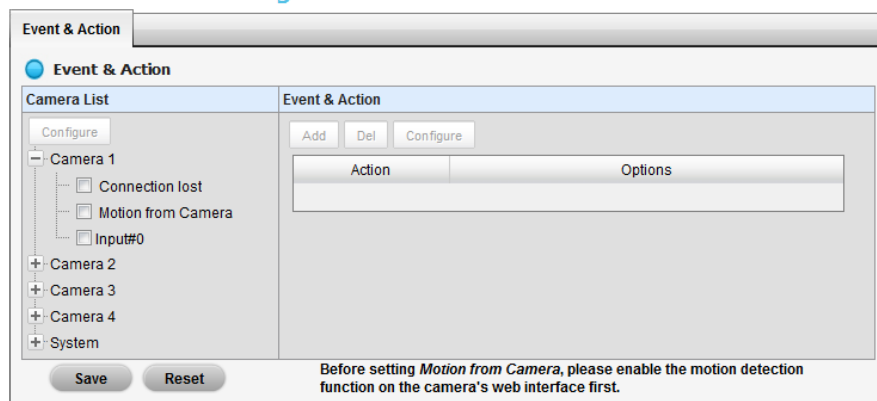

Event & Action

Camera List: Camera 1 (selected)

- Connection lost
- Motion from Camera
- Input#0

Camera 2, Camera 3, Camera 4, System

Buttons: Save, Reset

Before setting Motion from Camera, please enable the motion detection function on the camera's web interface first.

- **Connect lost**: When a connection between the camera and this unit is lost, the system will trigger an action.
- **Motion from Camera**: When video motion is detected, the camera triggers an action.
- **Input**: Any external input can trigger an action.



When setting the event ***Motion from Camera***, make sure to set up the camera's motion detection function first. Besides, event log will be recorded only if event is selected on this page.

4. Click the **Configure** button to enable the event and select the active period.

The screenshot shows a dialog box titled "Event Configuration". It has a close button (X) in the top right corner. Inside the dialog, there is a checkbox labeled "Enable Event". Below it is a section titled "Active Period" containing two radio buttons: "Always Active" (which is selected) and "Active only in the following period". Under the second radio button, there are two time input fields separated by "to", both showing "00:00". Below the "Active Period" section is another section titled "IO Type" with two radio buttons: "N/O" (selected) and "N/C". At the bottom right of the dialog are "OK" and "Cancel" buttons.

- **Always Active**: The selected event is always active.
- **Active only in the following period**: The selected event is only active in the designated time, which able to cover two days e.g. from 18:00 to 09:00.
- **I/O Type**: Check one of the options of I/O type. N/O means normal open, while N/C means normal close.

5. Click the **Add** button to set up the responding actions of this event.

Event & Action Management

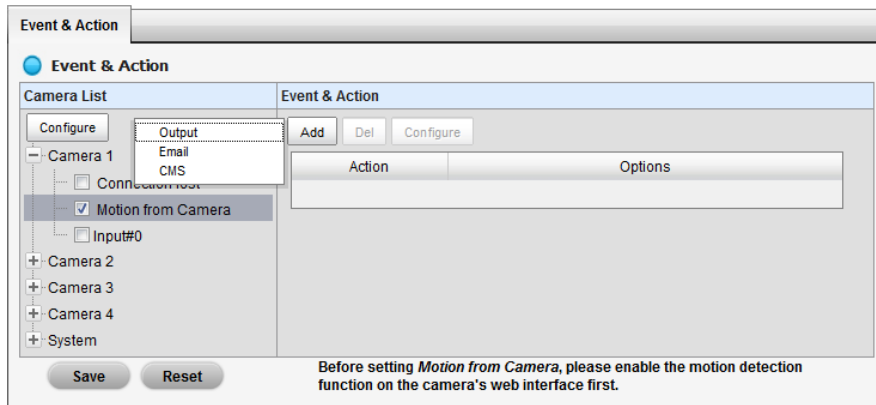

- **Output:** When an event occurs, the system will send an output signal to other connected devices.
- **Email:** When an event occurs, the system will send Email notifications. Make sure to add an Email address first.
- **CMS:** When an event occurs, the system will send out a signal to CMS. CMS will highlight this event.

6. Click the action, and then click the **Configure** button to modify the details of that action if necessary.
7. Click the **Save** button.



After selecting camera events, the event information will display on the screen when it's triggered.

2.2.4 System Events and Responding Actions Setup

1. Open Internet Explorer and log in to the unit.
2. Click **Recording & Event / Event & Action Management**.
3. Click the **Event & Action** tab.
4. Click **System** to unfold the list of system events, and then select one of the five events.

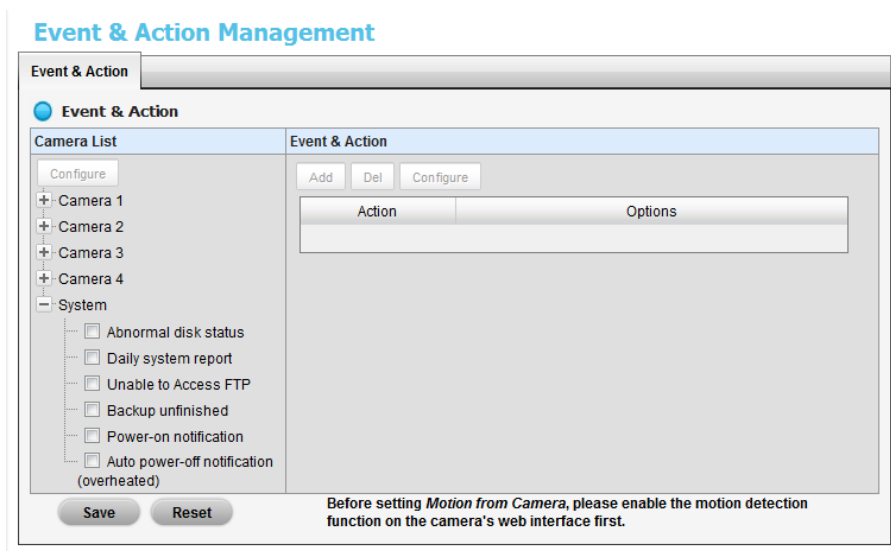

- **Abnormal disk status**: When there is no enough disk space for recording or when disk is abnormal for accessing, the system will trigger an action.
 - **Daily system report**: Enable users to know the system information, HDD usage, and Disk status everyday through Email without accessing to the unit to check.
 - **Unable to access FTP**: The action will be triggered when the connection between the unit and FTP server is lost.
 - **Backup unfinished**: If there is any file which the system didn't complete the backup process, the file(s) name will be listed and send out through Email after finishing the last file of this backup schedule.
 - **Power-on notification**: Record the time as power was turning on.
 - **Auto power-off notification**: If overheat was happened, users will be notified that power is auto off via Email.
5. Click the **Add** button to set up the responding actions of this event. Follow the steps in the previous section.
 6. Click the **Save** button.



Email is the only action to the event **Daily system report**, **Unable to access FTP**, **Backup unfinished**, **Power-on notification** and **Auto power-off notification (overheat)**. In addition to select a contact, remember to insert the time of sending daily system report.

The image shows a dialog box titled "Daily System Report Configuration". It has two main sections: "Automatically Send Daily System Report" with a time input field set to "00:00", and "Contact List" with a checked checkbox next to "Guard <guard@xxx.com>". At the bottom right, there are "Ok" and "Cancel" buttons.

2.2.5 SMTP Server Setup

1. Open Internet Explorer and log in to the unit.
2. Click **Recording & Event / Email**.
3. Click the **SMTP Server** tab.

The image shows the "Email" configuration interface with the "SMTP Server" tab selected. The "SMTP Server" section is active, showing fields for "Server Address", "Port" (set to 465), and "use SSL" (checked). The "Sender" field is empty, and the "Subject" is "NVR Event". The "Body" field contains the text: "Some issue occurred! Please check the NVR server in B Block." Below this, there is an "SMTP Authentication" section with a checked checkbox, and fields for "Username" and "Password". At the bottom, there are "Save", "Reset", and "Send Test Mail" buttons.

- **Server Address:** SMTP (Simple Mail Transport Protocol) server IP address.
- **Port:** SMTP port.
- **Sender:** Sender information.
- **Subject:** The subject of the mail.
- **Body:** Email content.
- **SMTP Authentication:** Before sending out an Email, enter the username and password for SMTP authentication.
- **Username**
- **Password**

4. Click the **Send Test Mail** button and the system will send a test mail to the sender. Check it after testing.

5. Click the **Save** button.

2.2.6 Add Event Contacts

1. Open Internet Explorer and log in to the unit.
2. Click **Recording & Event / Email**.
3. Click the **Contacts** tab.

The screenshot shows a web interface titled "Email" with two tabs: "SMTP Server" and "Contacts". The "Contacts" tab is active. Below the tabs, there is a "Contact" section with a blue header and a radio button. It contains two input fields: "Name" and "Email". Below these fields is an "Add Contact" button. Underneath is a table with three columns: "Name", "Email", and "Delete". At the bottom of the form are "Save" and "Reset" buttons.

- **Add Contact:** Add this new contact into the contact list. (Maximum: 40 contacts)
- **Reset:** Return to the latest saved settings of the contact list.
- **Save:** Save this time modification of the contact list.

4. Insert the name of a new contact.
5. Insert the Email address of this new contact.
6. Click the **Add Contact** button.
7. Click the **Save** button to save this modification of the contact list.

2.3 RAID & File Settings

2.3.1 Create a RAID Volume

In this system, the term RAID volume refers to one or more disk drives working together as a RAID logical drive. You must create a RAID volume before starting to record.

1. Open Internet Explorer and log in to the unit.
2. Click **RAID & File System / RAID Management**.
3. Click the **Create** tab.

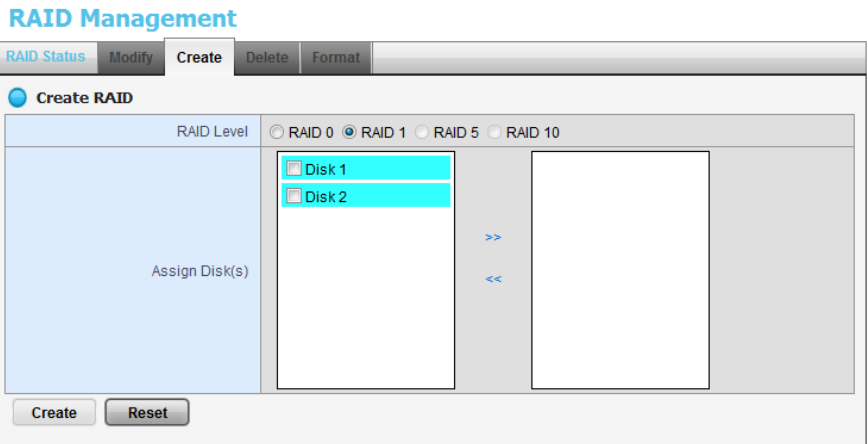

4. Choose the RAID level you prefer for your disk array.
5. Check boxes of disks and click the >> button to assign disk drives for this volume.
6. Click the **Create** button.
7. A confirmation dialog pops up. Check the **Yes, I want to create volume with those disk(s)** box, and click the **Yes, create it** button.

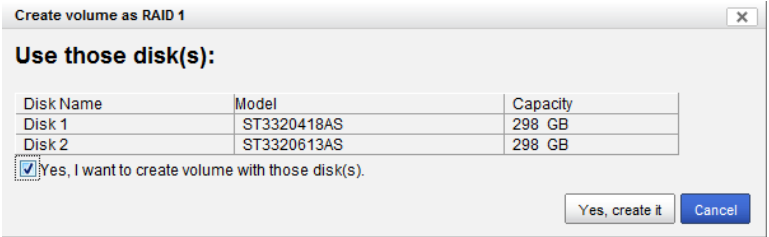

8. Creating RAID volume takes a while, depending on the size of disks and the RAID level you choose. You can start recording during RAID creation.

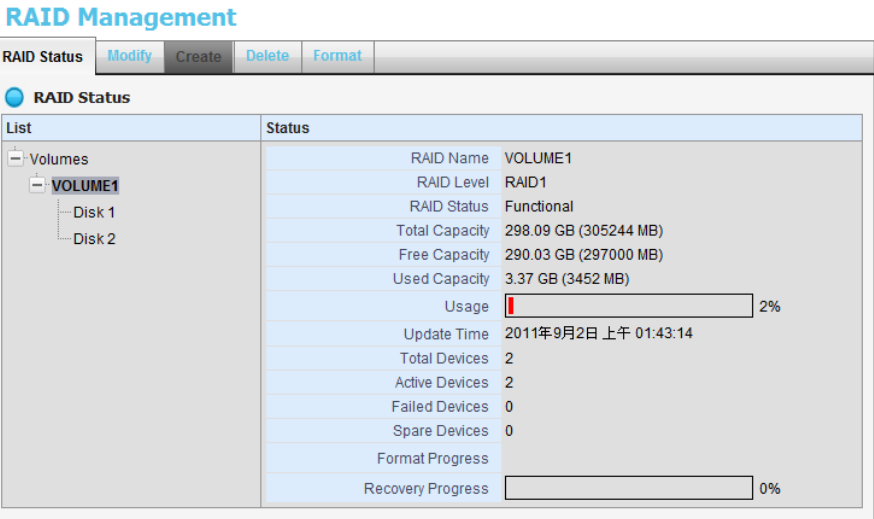



The RAID Volume will be functional on another unit if **all** disks of this volume are moved to the unit.



After setting RAID level, you are not allowed to change neither the RAID level nor the number of disks containing in this volume.



To reduce the possibility of having problems to access public folder via My Network Places, before creating new disk volume or modifying volume, please delete the invalid volume if any.



If you choose Express Mode when using the **Installation Wizard**, the disk(s) will be set to RAID 0 automatically unless the number of disks is not enough for this RAID level.

2.3.2 View RAID Volume Status

RAID status refers to the disk drives on your unit and how they are arranged into a RAID volume.

1. Open Internet Explorer and log in to the unit.
2. Click **RAID & File System / RAID Management**.
3. Click the **RAID Status** tab to view the status of your RAID Volume.

The screenshot displays the RAID Management interface. At the top, there are tabs for RAID Status, Modify, Create, Delete, and Format. The RAID Status tab is selected. Below the tabs, there is a tree view on the left showing Volumes, with VOLUME2 expanded to show Disk 2 and VOLUME1 expanded to show Disk 1. The main area shows the RAID Status for VOLUME2, including RAID Name, RAID Level, RAID Status, Total Capacity, Free Capacity, Used Capacity, Usage (2%), Update Time, Total Devices, Active Devices, Failed Devices, Spare Devices, Format Progress, and Recovery Progress.

List	Status
Volumes	RAID Name VOLUME2
VOLUME2	RAID Level RAID0
Disk 2	RAID Status Functional
VOLUME1	Total Capacity 298.08 GB (305244 MB)
Disk 1	Free Capacity 289.87 GB (296832 MB)
	Used Capacity 3.53 GB (3620 MB)
	Usage <input type="text" value="2%"/>
	Update Time 2011年9月2日 下午 06:34:32
	Total Devices 1
	Active Devices 1
	Failed Devices 0
	Spare Devices 0
	Format Progress
	Recovery Progress

- **RAID Name:** Name of your RAID, automatically assigned when it was created.

- **RAID Level:** RAID 0, 1, 5, or 10, specified when it was created.
- **RAID Status:** **Functional** is normal. **Critical** means there are some problems on RAID volume, but the recording status is normal. **Offline** means that no volume is found, so recording is stopped and you cannot access your data either. **File system error** means that RAID volume is existed but unmounted, so recording is stopped and you cannot access your data either.
- **Capacity:** Total, free, used data capacity of the RAID volume.
- **Update Time:** The time of volume created/updated.
- **Devices:** Total number of disks and the number of active, failed, spare disks.
- **Format Progress:** The status of RAID format
- **Recovery Progress:** The status of RAID recovery

2.3.3 View Disk Drive Information

1. Open Internet Explorer and log in to the unit.
2. Click **RAID & File System / RAID Management**.
3. Click the **RAID Status** tab.
4. Click on a disk directly to view the information.

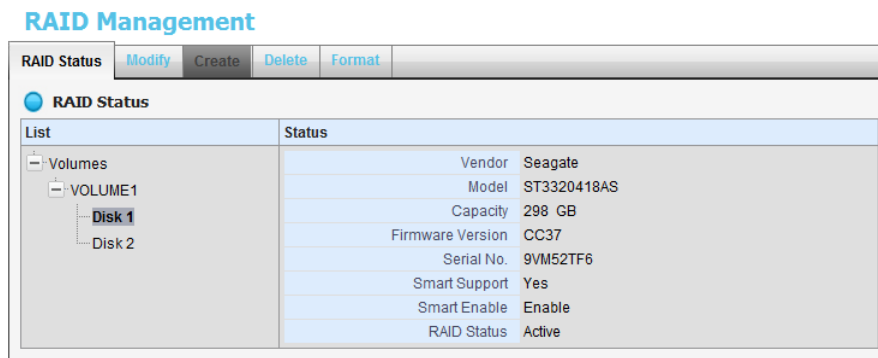

2.3.4 Modify RAID Volume

This function is designed for replacing a broken hard drive with a new one, instead of modifying RAID level.

In the condition of critical RAID status, it's a warning to show that one of disks of this RAID volume may be damaged. Even though it's no impact on the recording function, you'd better to replace a new disk to make sure the volume with data protection mechanism.



This function is not applied to RAID 0, since there is no data protection mechanism by its nature.



In case of any unexpected damage, we recommend users to unplug running HDD by this method, which can be viewed as security hard drive remove.

1. Open Internet Explorer and log in to the unit.
2. Click **RAID & File System / RAID Management**.
3. Click the **Modify** tab.

RAID Management

RAID Status **Modify** Create Delete Format

RAID List

Volume	RAID Level	RAID Capacity	RAID Status	Details
VOLUME1	RAID1	298.09 GB	Critical	Details

Free Disk List

Disk Name	Model	Capacity	Details
Disk 2	ST3320613AS	298 GB	Details

Modify Volume

RAID Name	
RAID Level	
Capacity	
RAID Status	
Actions	<input type="radio"/> Remove Disk <input type="radio"/> Add Disk

Modify Reset

4. Click on the volume you want to modify. The information of this volume will be displayed under the **Modify Volume** section.

RAID Management

RAID Status **Modify** Create Delete Format

RAID List

Volume	RAID Level	RAID Capacity	RAID Status	Details
VOLUME1	RAID1	298.09 GB	Critical	Details

Free Disk List

Disk Name	Model	Capacity	Details
Disk 2	ST3320613AS	298 GB	Details

Modify Volume

RAID Name	VOLUME1
RAID Level	RAID1
Capacity	298.09 GB
RAID Status	Critical
Actions	<input type="radio"/> Remove Disk <input checked="" type="radio"/> Add Disk <input checked="" type="radio"/> Disk 2: 298 GB ST3320613AS

Modify Reset

5. After removing the damaged disk. Add a free disk to replace the damaged, and click the **Modify** button.
6. A confirmation dialog pops up. Check the **Yes, I want to modify this volume** box, and click the **Yes, modify it** button.

Modify Volume ✕

Are you sure to modify this volume?

RAID Name	VOLUME1
RAID Level	RAID1
Capacity	298.09 GB
RAID Status	Functional
Assigned Disks	Disk 1 298 GB ST3320418AS Disk 2 298 GB ST3320613AS

Action for modifying volume:

Remove Disk

Disk 2 298 GB ST3320613AS SD22 9SZ0KN70 Active

Yes, I want to modify this volume.

Yes, modify it Cancel

7. Modifying RAID volume takes a while, depending on the size of disks you choose. Recording won't be stopped during the modification, and the data of this RAID volume is fully accessible.

RAID Management

The screenshot shows the RAID Management interface with the 'RAID Status' tab selected. The 'RAID Status' section displays the following information:

Property	Value
RAID Name	VOLUME1
RAID Level	RAID1
RAID Status	Functional
Total Capacity	298.09 GB (305244 MB)
Free Capacity	289.87 GB (296832 MB)
Used Capacity	3.53 GB (3620 MB)
Usage	2%
Update Time	2011年9月2日 下午 06:26:54
Total Devices	2
Active Devices	1
Failed Devices	0
Spare Devices	1
Format Progress	
Recovery Progress	8%

2.3.5 Delete a RAID Volume

1. Open Internet Explorer and log in to the unit.
2. Click **RAID & File System / RAID Management**.
3. Click the **Delete** tab.

RAID Management

The screenshot shows the RAID Management interface with the 'Delete' tab selected. The 'RAID List' section displays the following table:

	Volume	RAID Level	RAID Capacity	RAID Status	Details
<input checked="" type="radio"/>	VOLUME2	RAID0	298.08 GB	Functional	Details
<input type="radio"/>	VOLUME1	RAID0	298.08 GB	Functional	Details

Buttons: Delete, Reset

4. Click the option button beside the RAID Volume you want to delete.
5. Click the **Delete** button.
6. A confirmation dialog pops up. Check the **Yes, I want to delete this volume** box, and click the **Yes, delete it** button.

The screenshot shows a 'Delete Volume' confirmation dialog box with the following content:

Are you sure to delete this volume?

Volume	VOLUME1		
Assigned Disks	Disk Name	Model	Capacity
	Disk 1	ST3500514NS	465 GB

Yes, I want to delete this volume.

Buttons: Yes, delete it, Cancel

7. System will restart automatically after RAID volume is deleted



When you delete a RAID Volume, all the folders in the RAID volume and all the data saved in the folders will be deleted. Backup any important data before deleting a RAID Volume.

2.3.6 Format

Neither pressing reset button nor loading default setting, the data of RAID volume won't be deleted, which implies that format is the only way to clean the RAID information from disks.

1. Open Internet Explorer and log in to the unit.
2. Click **RAID & File System / RAID Management**.
3. Click the **Format** tab.

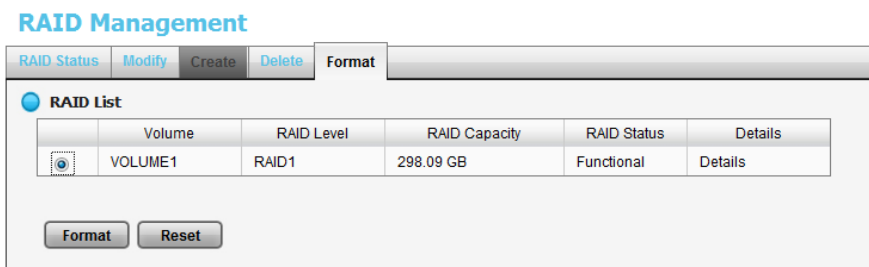

4. Click the option button beside the RAID Volume you want to format.
5. Click the **Format** button.
6. A confirmation dialog pops up. Check the **Yes, I want to format this volume** box, and click the **Yes, format it** button.

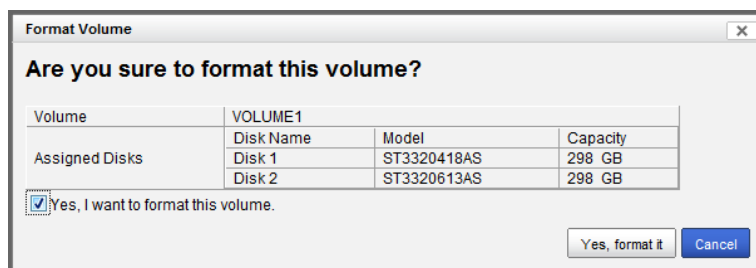

7. System will restart automatically after volume format is complete.

2.3.7 Modify the FTP Protocol Settings

1. Open Internet Explorer and log in to the unit.
2. Click **RAID & File System / Protocol Control**.

3. Click the **FTP Sharing** tab.
4. Check and enter the settings of this unit.
5. Click the **OK** button.

Protocol Control

FTP Sharing

FTP Settings

Services	<input type="radio"/> Enable <input checked="" type="radio"/> Disable
Command Port	21
Passive Ports	1024 ~ 65535

OK Cancel

- **Services:** Whether users can access this unit through FTP or not.
- **Command Port:** The port for commands between a server and a client.
- **Passive Ports:** The data transmission port of passive mode.

2.4 Auto Backup

This feature enables you to automatically backup the recorded video of the previous date to FTP site. There are two steps to enable the function, one is **Set up Backup Schedule**, another is **Set up Backup Server**.

2.4.1 Set up Backup Schedule

1. Open Internet Explorer and log in to the unit.
2. Click **RAID & File System / Auto Backup Management**.
3. Click the **Backup Schedule** tab.
4. Set up backup schedule, select the backup channels, and check the **Enable** option to enable **Auto Backup**.

Auto Backup Management

Backup Schedule Backup Server

Backup Schedule

Auto Backup	<input checked="" type="checkbox"/> Enable
Daily Backup Time	00 : 00
Video Start Time	07 : 00
Video End Time	18 : 00
Camera	select: all / none <input checked="" type="checkbox"/> Camera 1 <input checked="" type="checkbox"/> Camera 2 <input checked="" type="checkbox"/> Camera 3 <input checked="" type="checkbox"/> Camera 4

Current Event Settings

Unable to access FTP	disable
Backup Unfinished	disable

Save Reset

- **Auto Backup**: Check the **Enable** option to enable this function.
- **Daily Backup Time**: The daily scheduled time to start backup process.
- **Video Start Time**: The start time of recorded video of the previous date.
- **Video End Time**: The end time of recorded video of the previous date.
- **Camera**: Select the channel(s) to backup.

5. **Current Event Settings** shows the condition of the events of auto backup – enable or disable. Follow the steps of **System Events and Responding Actions Setup** to configure the event & action.



The system backs up recorded video files one by one. If the connection between the unit and FTP server is normal, but some problems of FTP causes the system unable to write files on FTP, the system would try each file three times before starting to backup the next file. If the connection is lost, the system would wait for the connection, so no file would be skipped.

2.4.2 Set up Backup Server

1. Open Internet Explorer and log in to the unit.
2. Click **RAID & File System / Auto Backup Management**.
3. Click the **Backup Server** tab.
4. Set up the FTP server and create a folder for backup files. The folder format is "FolderName", "FolderName/SubFolderName", and so on.

For example: AutoBackup/NVR

Auto Backup Management

Backup Schedule | **Backup Server**

Backup Server

FTP Site	test.dnsalias.com
FTP Port	21
Username	ABC
Password	••••••
Backup to Remote Folder	AutoBackup/NVR

Save Reset Test FTP

5. After setting up all the information, click the **Test FTP** button and the system will create a folder to FTP. Check it after testing. In this case, the route of the tested file will be:

ftp://test.dnsalias.com/AutoBackup/NVR/NVR_ComputerName

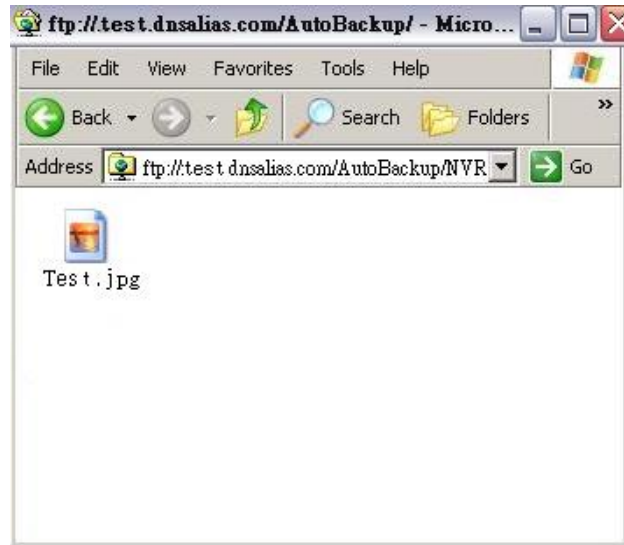

6. Click the **Save** button.



Make sure the FTP account with privileges of administrator who is able to upload, rewrite, delete files, and create new folder. Besides, make sure the FTP server has enough space for auto backup.



To avoid the failure of auto backup, please check the normality of FTP server regularly (e.g., enough space for video, system conditions.)

2.5 Network Setup

2.5.1 View Network Status

1. Open Internet Explorer and log in to the unit.
2. Click **Network Setup / Network Setup**.
3. Click the **Information** tab to view the unit's network information.

Network Setup

Information	Setup	DDNS Setup	UPnP Port Forwarding
Common Information			
Server Name	NVS-4		
Ethernet Adapter 1 Information			
IP Address	192.168.4.137		
Subnet Mask	255.255.252.0		
Default Gateway IP Address	192.168.4.1		
Primary DNS	192.168.4.1		
Secondary DNS			
Ethernet Adapter 2 Information			
IP Address			
Subnet Mask			
Default Gateway IP Address			
Primary DNS			
Secondary DNS			
Built-in DHCP Information			
Setting/Status	Always disable (Disable)		
IP Address	192.168.4.137		

2.5.2 Network Settings

1. Open Internet Explorer and log in to the unit.
2. Click **Network Setup / Network Setup**.
3. Click the **Setup** tab to set up the network settings of your unit.

Network Setup

Information
Setup
DDNS Setup
UPnP Port Forwarding

Common Setting

Server Name	<input type="text" value="solo_1040"/>
-------------	--

Ethernet Adapter 1 Setting

Internet Protocol	<input type="radio"/> Obtain an IP address automatically <input checked="" type="radio"/> Specify an IP address
IP Address	<input type="text" value="192.168.4.96"/>
Subnet Mask	<input type="text" value="255.255.252.0"/>
Default Gateway IP Address	<input type="text" value="192.168.4.1"/>
Primary DNS	<input type="text" value="192.168.4.1"/>
Secondary DNS	<input type="text"/>

Ethernet Adapter 2 Setting

Internet Protocol	<input checked="" type="radio"/> Obtain an IP address automatically <input type="radio"/> Specify an IP address
IP Address	<input type="text" value="192.168.2.100"/>
Subnet Mask	<input type="text" value="255.255.255.0"/>
Default Gateway IP Address	<input type="text" value="192.168.2.1"/>
Primary DNS	<input type="text" value="192.168.2.1"/>
Secondary DNS	<input type="text"/>

Built-in DHCP Setting

Setting	<input type="radio"/> Smart enable <input checked="" type="radio"/> Always disable
IP Address	<input type="text"/>
Subnet Mask	<input type="text"/>
Default Gateway IP Address	<input type="text"/>
Primary DNS	<input type="text"/>
Secondary DNS	<input type="text"/>
Starting IP Address	<input type="text"/>
Ending IP Address	<input type="text"/>

Network Setup

Information	Setup	DDNS Setup	UPnP Port Forwarding
Common Setting			
Server Name	NVS-4		
Ethernet Adapter 1 Setting			
Internet Protocol	<input checked="" type="radio"/> Obtain an IP address automatically <input type="radio"/> Specify an IP address		
IP Address	192.168.1.100		
Subnet Mask	255.255.255.0		
Default Gateway IP Address	192.168.1.1		
Primary DNS	192.168.1.1		
Secondary DNS			
Ethernet Adapter 2 Setting			
Internet Protocol	<input checked="" type="radio"/> Obtain an IP address automatically <input type="radio"/> Specify an IP address		
IP Address	192.168.2.100		
Subnet Mask	255.255.255.0		
Default Gateway IP Address	192.168.2.1		
Primary DNS	192.168.2.1		
Secondary DNS			
Built-in DHCP Setting			
Setting	<input type="radio"/> Smart enable <input checked="" type="radio"/> Always disable		
IP Address			
Subnet Mask			
Default Gateway IP Address			
Primary DNS			
Secondary DNS			
Starting IP Address			
Ending IP Address			
OK Cancel			

- **Server Name:** Name your unit.



Because of the internal data modifications required, it takes a few seconds to change the name of your unit. Log in again after configuration activated.

- **Internet Protocol:** Choose to obtain an IP address from external DHCP server automatically, or configure the IP address manually.
- **IP Address:** IP address of this unit.

- **Subnet Mask:** Subnet mask address.
- **Default Gateway IP Address:** Gateway IP address.
- **Primary DNS:** Primary DNS (Domain Name System) address.
- **Secondary DNS:** Secondary DNS address.



The unit specifies two Giga LANs. We recommend using them under the scenario of two subnets, one is for cameras/devices, and the other is for remote access. If you deploy two LANs on the same subnet, it's likely to make parts of camera disconnected as either one of LAN is disconnected.

- The unit possesses built-in DHCP service, which enables the system to dynamically assign IP addresses to the connected camera clients within the same subnet.
 - **Setting:** Two options of built-in DHCP service, smart enable and always disable. When you have router in your network, we strongly recommend choosing "always disable" to avoid any IP conflicts. If you are not sure if there is any router in your network, please choose "smart enable", which detects the network environment then decide to enable or disable the service.
 - **Starting IP Address:** The IP address for the built-in DHCP to start assigning from.
 - **Ending IP Address:** The end of the IP address that the built-in DHCP assigns.
- If you are using findNVR service. You can skip the DDNS setup. For more information, please refer to [findNVR](#).
- Click the **DDNS Setup** tab to enable Dynamic Domain Name Server function, allowing you to connect unit with dynamic IP address.

Network Setup

Information Setup **DDNS Setup** UPnP Port Forwarding

Dynamic DNS Setting

DDNS	<input type="checkbox"/> Enable
Provider	DynDns
User name	<input type="text"/>
Password	<input type="password"/>
Host name	<input type="text"/>
Update Period	16 minutes

Save Reset

2.5.3 Auto Port-Forwarding

If you are using findNVR service. You can skip this section. For more information, please refer to [findNVR](#).

This function is designed for saving time in port configuration on router if users want to access the unit (in LAN) from WAN. Once enabling UPnP Service on router, users can do port-forwarding for setting page (default: 80), liveview (default: 5150), playback (default: 5160), and CMS (default: 5170) automatically.

1. Open Internet Explorer and log in to the unit.
2. Click **Network Setup / Network Setup**.
3. Click the **UPnP Port-Forwarding** tab.
4. Click the **Search** button, and the searched routers will be listed.

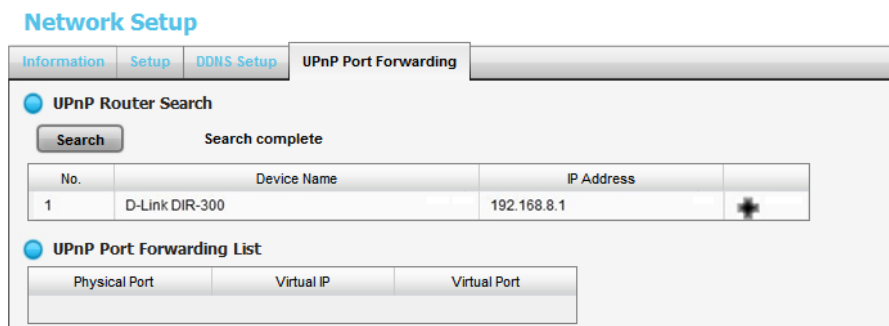

5. Select the searched router, and all UPnP ports configured on this router will show under the **UPnP Port Forwarding List**.

Network Setup

Information Setup DDNS Setup **UPnP Port Forwarding**

UPnP Router Search

Search Search complete

No.	Device Name	IP Address	LAN	
1	D-Link DIR-300	192.168.8.1	LAN1 (192.168.8.82)	+
2	D-Link DAP-1360		LAN1 (192.168.8.82)	+

UPnP Port Forwarding List

Physical Port	Virtual IP	Virtual Port
18403	192.168.9.55	80
554	192.168.9.55	554
80	192.168.9.159	80
26674	192.168.8.226	26673
1938	192.168.8.50	5868
33561	192.168.8.198	33561
33561	192.168.8.198	33561
7800	192.168.8.238	6663
65133	192.168.8.222	65133
14860	192.168.8.205	14860
14860	192.168.8.205	14860
26673	192.168.8.226	26673
26673	192.168.8.226	26673

6. After selecting one of searched routers, click the  icon to set up port-forwarding to this router automatically. You will find ports of setting, liveview, playback and CMS are listed.

Network Setup

Information Setup DDNS Setup **UPnP Port Forwarding**

UPnP Router Search

Search Search complete

No.	Device Name	IP Address	LAN	
1	D-Link DAP-1360		LAN1 (192.168.8.82)	+

UPnP Port Forwarding List

Physical Port	Virtual IP	Virtual Port
18910	192.168.8.238	18910
18910	192.168.8.238	18910
14861	192.168.1.190	14860
554	192.168.9.55	554
18403	192.168.9.55	80
33561	192.168.8.198	33561
33561	192.168.8.198	33561
26673	192.168.8.226	26673
26673	192.168.8.226	26673
14860	192.168.8.205	14860
14860	192.168.8.205	14860
64315	192.168.8.222	64315
64315	192.168.8.222	64315
8126	192.168.1.234	8126
8126	192.168.1.234	8126
80	192.168.8.82	80
5150	192.168.8.82	5150
5160	192.168.8.82	5160
5170	192.168.8.82	5170



For security reason, the privilege of UPnP port-forwarding is LOWER than port-forwarding configured on router. Therefore, if the ports have been used on router, we are unable to know before finding out access failure.



UPnP port-forwarding is for temporarily use only. Most of UPnP router will clean up all UPnP ports after router reboots. Furthermore, for some routers, if the port you want to add has already been used for other devices in the same way (UPnP port forwarding), this “enable” action will cover over the settings.

2.5.4 Network Service Setup

1. Open Internet Explorer and log in to the unit.
2. Click **Network Setup / Network Service**.
3. Click the **Web Service** tab
4. Set up a port for this unit and click the **Save** button.

Network Service

Web Service | **Live View & Playback Service** | CMS Service

Web Server

Management Port: 80

Save Reset

5. Click the **Live View & Playback Service** tab.

Network Service

Web Service | **Live View & Playback Service** | CMS Service

Live Streaming Server

Port: 5150

Maximum Connections: 16

Playback Server

Port: 5160

Maximum Users: 4

Log Access: Enable

Black/White List

White List: Enable

Black List: Enable

IP Range: [] to []

Add to White List Add to Black List

Index	IP	Access	Delete

Save Reset

- **Live Streaming Server**
 - **Port**: Live streaming transmission port.
 - **Maximum Connections**: Maximum connections from remote access. (Max: 64)
- **Playback Server**

- **Port**: Playback transmission port.
- **Maximum Users**: The number of users who can access playback functions at the same time. (Max: 8)
- **Log Access**: Check to record playback access information on NVR Log page, including access time, playback video channels, and time frame.
- **Allowed/ Blocked List**
 - **Allowed List**: Only IP addresses from the allowed list are allowed to log in.
 - **Blocked List**: IP addresses from the blocked list will be unable to log in.



When setting Maximum Connections in Live Streaming Server settings, 1 connection means that one user connects to one camera. If the maximum connections value is set to 16, and each user connects to 4 cameras, the allowed connections per user will become 4, rather than 16.

2.5.5 CMS Service Setup

1. Open Internet Explorer and log in to the unit.
2. Click **Network Setup / Network Service**.
3. Click the **CMS Service** tab.

Network Service

Web Service | Live View & Playback Service | **CMS Service**

● **CMS Server**

CMS Server	<input type="checkbox"/> Enable
Port	5170
Maximum Connections	8

Save Reset

- **CMS Server**: Check the **Enable** option to enable CMS service.
- **Port**: the port number through which the CMS connects to this unit.
- **Maximum Connections**: The maximum number of allowed CMS connections.

2.5.6 findNVR

findNVR is designed to truly simplify the process of establishing Internet access to NVR systems. It eliminates the need for setting up port forwarding and configuring DDNS. Simply register a server ID on the setting page, then go to findNVR website or sign in iSecurity App to watch live videos and playback from wherever you are.

1. Open Internet Explorer and log in to the unit.
2. Click **Network Setup / findNVR Registration**.
3. Click the **Registration** tab.

4. Enter a desired server ID in the Server ID field.
5. Click the **Test** button to check the availability of the desired server ID.
6. Click the **Save** button.
7. Now you can login to www.findnvr.com on a web browser to configure, watch live videos and playback with any other settings, such as port forwarding or DDNS setup. All you need to know is the server ID, username and password. What's more, you can also sign in to mobile app iSecurity to watch live videos and playback from everywhere you are.



To support to access to the NVR system via mobile app iSecurity, you have to upgrade the iSecurity to v3.0 or above.

2.6 Management

2.6.1 View the List of Users

1. Open Internet Explorer and login the unit.

2. Click **Management/ User Management**.
3. Click the **Create New Users** tab.
4. The list will be displayed on the bottom of the page.

No.	Name	Group	Live View	Playback	Local Sign-in	Local Configuration	Backup Data	Delete Data
1	supervisor	power user	1,2,3,4	1,2,3,4	O	O	O	O
2	guard	user	1,2,3,4	1,2,3,4	O	X	O	X
3	temp	guestuser	1,2,3,4		X	X	X	X

2.6.2 Create New Users

1. Open Internet Explorer and login the unit.
2. Click **Management/ User Management**.
3. Click the **Create New Users** tab.

User Management

Create New Users Modify Users Change Password

Create User

Username	<input style="width: 90%;" type="text"/>
Password	<input style="width: 90%;" type="password"/>
Group	power user ▾
Live View Access	<input checked="" type="checkbox"/> All <input checked="" type="checkbox"/> Channel 1 <input checked="" type="checkbox"/> Channel 2 <input checked="" type="checkbox"/> Channel 3 <input checked="" type="checkbox"/> Channel 4
Playback Access	<input checked="" type="checkbox"/> All <input checked="" type="checkbox"/> Channel 1 <input checked="" type="checkbox"/> Channel 2 <input checked="" type="checkbox"/> Channel 3 <input checked="" type="checkbox"/> Channel 4
Local Privilege	<input checked="" type="checkbox"/> Local Sign-in <input checked="" type="checkbox"/> PTZ Control <input checked="" type="checkbox"/> Configuration
Remote Privilege	<input checked="" type="checkbox"/> PTZ Control <input checked="" type="checkbox"/> IO Control <input checked="" type="checkbox"/> E-map Settings <input checked="" type="checkbox"/> Backup Data <input checked="" type="checkbox"/> Delete Data

Create New User Clear

4. Insert the username of this new user.
5. Insert the password of this new user.
6. Choose the group of this user.
 - **Power user**: Power user can do all the settings except the **Network Settings, RAID Settings, and Management function**.
 - **User**: User just can change his/her password and do the live view and playback functions.
 - **Guest user**: User can do live view and playback function only.
7. Select the live view cameras which this user can access.
8. Select the playback channels which this user can access.
9. Check whether this user can backup or delete recorded data.
10. Click the **Create New User** button to finish it.



The Administrator will be the only user who can use all of the functions. There is a default administrator account in the system, and you cannot create neither another "Administrator" account, nor another username named "admin".

2.6.3 Modify User Information

1. Open Internet Explorer and log in to the unit.
2. Click **Management / User Management**.
3. Click the **Modify Users** tab.
4. Click one of the users in the User List on the bottom of this page.

User Management

Create New Users **Modify Users** Change Password

Modify Users

Username: guard

Group: user

Live View Access: All Channel 1 Channel 2 Channel 3 Channel 4

Playback Access: All Channel 1 Channel 2 Channel 3 Channel 4

Local Privilege: Local Sign-in PTZ Control Configuration

Remote Privilege: PTZ Control IO Control E-map Settings
 Backup Data Delete Data

Modify User Clear

User List

No.	Name	Group	Live View	Playback	Local Sign-in	Local Configuration	Backup Data	Delete Data	
1	supervisor	power user	1,2,3,4	1,2,3,4	O	O	O	O	
2	guard	user	1,2,3,4	1,2,3,4	O	X	O	X	
3	temp	guestuser	1,2,3,4		X	X	X	X	

5. Change the group of this user.
6. Select the live view cameras which this user can access.
7. Select the playback channels which this user can access.
8. Check whether this user can backup or delete recorded data.
9. Click the **Modify User** button to finish it.

2.6.4 Change a User's Password

1. Open Internet Explorer and log in to the unit.
2. Click **Management / User Management**.
3. Click the **Change Password** tab.

User Management

Create New Users Modify Users **Change Password**

Change Password

Username: guard

New Password:

Retype Password:

OK Clear

4. Choose the user.
5. Enter a new password.
6. Enter this new password again.
7. Click the **OK** button.

2.6.5 Delete Users

Except for the administrator, you can delete any users with the following steps.

1. Open Internet Explorer and log in to the unit.
2. Click **Management / User Management**.
3. Click the **Modify Users** tab.
4. Click the Delete icon of the user you want to delete.

No.	Name	Group	Live View	Playback	Local Sign-in	Local Configuration	Backup Data	Delete Data
1	supervisor	power user	1,2,3,4	1,2,3,4	O	O	O	O
2	guard	user	1,2,3,4	1,2,3,4	O	X	O	X
3	temp	guestuser	1,2,3,4		X	X	X	X

5. In the confirmation box, click the **OK** button.

2.6.6 Online License Activation

There are two types of license currently, camera license and POS license. With the camera license upgrade, the 4ch-device will possess up to 8ch capacity. With the POS license upgrade, users can use **POS function**.

There are two ways to activate license, online and offline.

1. Open Internet Explorer and log in to the unit.
2. Click **Management / License Management**.

License Management

Activate

Online Activation

S/N Type Input S/N:

Activate

Offline Activation

Step 1: Export server information file

Export

Step 2: Copy exported offline.reg to PC connected to the Internet, and execute "OffLineTool.exe" to activate license and get the offline license file

Step 3: Import offline license file

S/N Type Import license file: **Import...**

Import

License List

S/N	Channel	Product	Status
* There are no licenses yet.			

3. Select **Online** as the Activation Type, input serial number, and click the **Activate** button.
4. The license will be updated in License List if activated successfully. System will reboot automatically.

License List

S/N	Channel	Product	Status
XXXX-XXXX-XXXX-XXXX	2	NVS	Activated

2.6.7 Offline License Activation

If the device is set up in Intranet (Local LAN) without Internet connection, there is another way to activate license.

1. Open Internet Explorer and log in to the unit.
2. Click **Management / License Management**.

License Management

The screenshot shows the 'License Management' window with the 'Activate' tab selected. It features three main sections: 'Online Activation', 'Offline Activation', and 'License List'. The 'Online Activation' section has a radio button selected for 'Input S/N:' and an 'Activate' button. The 'Offline Activation' section includes instructions for exporting server information, copying the file to another PC, and importing the license file, with an 'Export' button. The 'License List' section shows a table with columns for S/N, Channel, Product, and Status, and a message stating 'There are no licenses yet.'

3. Click the **Export** button under the section of **Offline** Activation to export the information of this unit.
4. Download dialog pops up. Save the request file and take it to other PC which is connected to the Internet. Furthermore, the PC should be installed **OffLineTool.exe** which can be found from NVR toolkit.

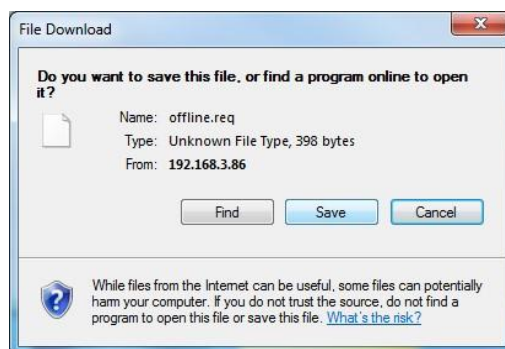

5. Execute the OffLineTool.exe in that PC with Internet connection, and select the request file **offline.req**.

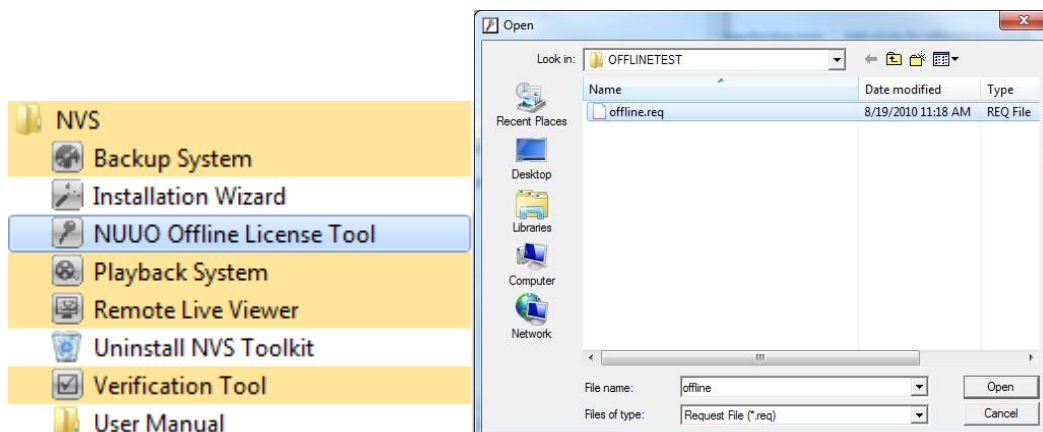

- Input the serial number, click the **Activate** button, and save the .dll file **offline_license.dll**.

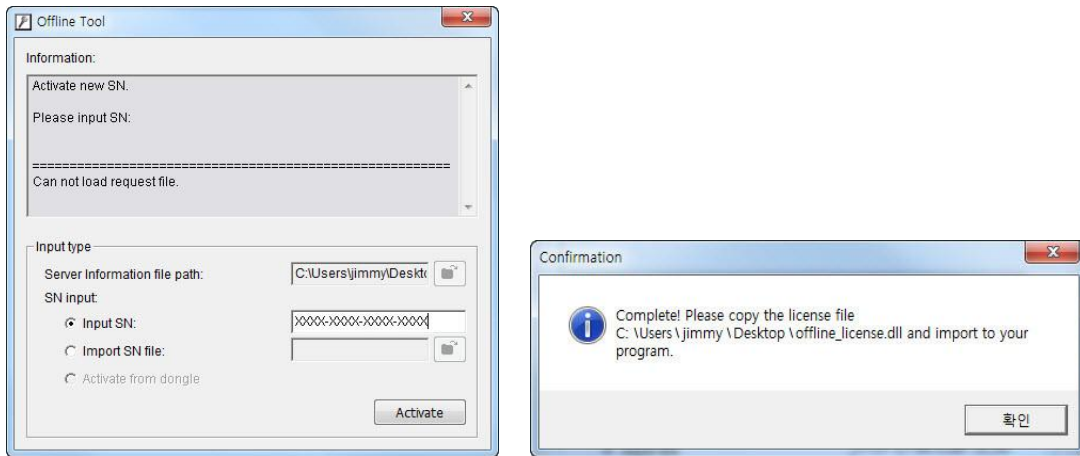

- Import the license file to the unit.

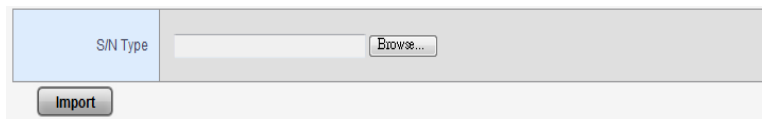

- The license will be updated in License List if activated successfully. System will reboot automatically.

License List			
S/N	Channel	Product	Status
XXXX-XXXX-XXXX-XXXX	2	NVS	Activated

2.6.8 View the Event Log

- Open Internet Explorer and log in to the unit.
- Click **Management / Log System** to find the event list of your unit.

Log System

Hardware Log	NVR Log	NVR Event Log	Export and Backup Log
Hardware Log List			
Last 20 100 500 1000 all logs			
<< < 1 > >>			
Date / Time	Level	Message	
2011/08/25 (Thu) 05:16:51	info	Time zone settings has been changed	
2011/08/25 (Thu) 05:16:51	info	Date/time settings has been changed	
2011/08/22 (Mon) 18:38:56	info	NVR system starts	
2011/08/22 (Mon) 18:38:56	info	VOLUME1 is ready	
2011/08/22 (Mon) 18:38:55	info	RAID info of Disk1: level 0, uuid b4de1c93:f0169959:af6a7864:2c28b940, 1 device(s)	
2011/08/22 (Mon) 18:38:55	info	Disk1 is found	

There are four kinds of event which will be listed on this page.

- **Hardware Log**: The log information of the operations to your unit, such as reboot or shut down.
- **NVR Log**: The log information of the NVR system, such as system, recording, user access information, POS and auto backup.
- **NVR Event Log**: The log information of the "Event & Action Management", such as motion detection or camera connection lost.
- **Backup and Export Log**: The log information of the track of video data exported and backup.



The NVR Event Log will be recorded only if event is selected on **Event & Action Management** page. As for user access information, please go to **Network Service** to check **Log Access** box to enable this function.

2.6.9 Save Unit Configuration

Save configuration can let you save the settings of this unit. These settings can be applied to other units, which will let you set other units more easily.

1. Open Internet Explorer and log in to the unit.
2. Click **Management / Save / Load Configuration**.
3. Click the **Save Configuration** tab.

Save/Load Configuration

The screenshot shows the 'Save Configuration' tab of the 'Save/Load Configuration' dialog. It features a 'Save Configuration' radio button, a 'Save' button, and optional checkboxes for 'E-Map Settings' and 'POS Settings'. The text below the radio button reads: 'Click the Save button to save the configuration of Camera Settings, Recording Settings, Event & Action Settings, E-Mail Settings and Server Settings.'

4. Check the box of **E-Map Settings** or **POS Settings** if you want to keep the configuration.
5. Click the **OK** button.
6. The configuration file will be generated into the chosen folder.



User account won't be exported as saving configuration, which implies the user list of push notification won't be saved as well.

2.6.10 Load Unit Configuration / Default Settings

Load configuration can let you apply another unit's settings to the current unit; Load Default Settings will revert all of the unit's settings back to the default factory settings.

1. Click **Management / Save / Load Configuration**.
2. Click the **Load Configuration** tab.

Save/Load Configuration

The screenshot shows the 'Load Configuration' tab of the 'Save/Load Configuration' dialog. It features a 'Load Default Settings' radio button with a 'Load' button below it, and a 'Load Configuration' radio button with a 'File Name' field, a 'Browse...' button, and a 'Load' button below it. The text below the 'Load Default Settings' radio button reads: 'Click the Load button to load default factory settings. Uncheck the following box if you want to keep the network settings.' The 'Optional' section for 'Load Default Settings' has a checked checkbox for 'Network Settings'. The 'Optional' section for 'Load Configuration' has unchecked checkboxes for 'E-Map Settings' and 'POS Settings'.

3. Follow the direction to **Load Default Settings** or **Load Configuration**. For the former, uncheck the box of **Network Settings** to keep the IP address; for the latter, check the box of **E-Map Settings** or **POS Settings**

- if you want to restore the configuration.
- Click the **Load** button.
 - A confirmation dialog pops up. Click the **OK** button to begin to load the settings into your unit.



If there is POS database existed in the unit, loading configuration with different POS application config is likely to make the original POS data unsearchable.



If the saved configuration is without E-map or POS settings, selecting loading configuration with E-map/POS settings will lead you get the default. The original E-map/POS settings (if any) are covered and untraceable.



User account and privilege will be kept even if loading default settings, while camera settings, recording schedule, event & action settings, Email setting and server settings won't be. **RAID information** will always be kept whether loading default settings or loading configuration.

2.7 System

2.7.1 View System Information

- Open Internet Explorer and log in to the unit.
- Click **System / System Information**.

System Information

System Information	
● Information	
Operating System	Linux
NVR Version	01.00.0104.0215
Device Pack Version	02.08.0000.0011
CPU	ARMv7 Processor rev 0 (v7l)
MAC Address 1	08:7D:21:00:A0:3C
MAC Address 2	08:7D:21:00:A0:3D
CPU Temperature	37.000 °C
System Fan Speed	3110 RPM
Locate	<input type="button" value="Locate"/>

The system information includes the following items.

- **Operating System**: Embedded Linux
- **NVR Version**: NVR system version
- **Device package version**: Camera package version
- **CPU**: CPU model number
- **CPU Loading**: The approx. CPU loading of this unit

- **MAC Address:** MAC address of this unit
- **CPU Temperature**
- **System Fan Speed**
- **Locate:** Click to trigger the buzzer to let you know where the unit is

2.7.2 Smart Fan Control

1. Open Internet Explorer and log in to the unit.
2. Click **System / System Settings**.
3. Click the **Fan Control** tab.

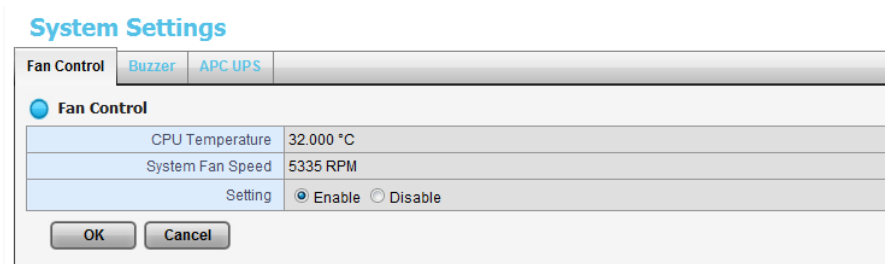

4. Check the **Enable** or **Disable** option.
5. Click the **OK** button.

2.7.3 Buzzer Configuration

There is a buzzer in the unit. When the unit finishes booting or when a problem is detected, this buzzer will sound. This buzzer is enabled by default. You can disable/enable this buzzer with the following steps. (We recommend that this buzzer should be enabled.)

1. Open Internet Explorer and log in to the unit.
2. Click **System / Settings**.
3. Click the **Buzzer** tab.

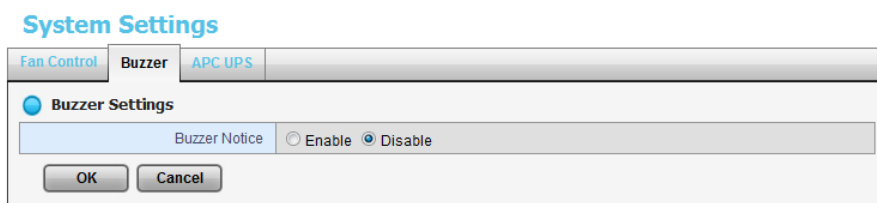

4. Check the **Enable** or **Disable** option.
5. Click the **OK** button.

2.7.4 UPS Setup

This feature enables you to tell your unit how long to run on APC Uninterruptable Power Supply (UPS) battery power and when to shut down, after power failure.

1. Attach the APC UPS to one of the unit's USB ports.
2. Open Internet Explorer and log in to the unit.
3. Click **System / Settings**.
4. Click the **APU UPS** tab.
5. Check one of the options:

The screenshot shows the 'System Settings' window with the 'APC UPS' tab selected. It is divided into two sections: 'Information' and 'Power Failure Action'. The 'Information' section contains a table with the following data:

Manufacturer	APC
Product Name	Smart-UPS 3000 FW:655.18.D USB FW:7.4
Serial Number	JS0939022759
Service Status	ON

The 'Power Failure Action' section has three radio button options:

- Disable
- System shutdown as power of the UPS remains %
- System shutdown as power of the UPS remains Min.

At the bottom, there are 'OK' and 'Cancel' buttons. A tooltip is visible over the third option, displaying the text 'System shutdown as power of the UPS remains'.

- **Disable**: Run until the UPS battery is depleted
- **System shutdown as power of the UPS remains ___ %**: Run until the UPS battery remains this percentage.
- **System shutdown as power of the UPS remains ___ min.:** Run until the UPS battery remains the certain period of time.

6. Fill in the specific value if you choose the last two options.
7. Click the **OK** button.

2.7.5 Upgrade the System

1. Open Internet Explorer and log in to the unit.
2. Click **System / Upgrade**.
3. Click the **Firmware Upgrade** tab.

System Upgrade

Firmware Upgrade

Upgrade

Current NVR Version	01.00.0104.0215
Current Device Pack version	02.08.0000.0011
Select file	<input type="text"/> <input type="button" value="Browse..."/>

4. Browse the FW for upgrading and click the **OK** button.
5. A confirmation dialog pops up. Click the **OK** button to start upgrade process.
6. After upgrade, the system will restart. You need to re-access the unit again after this.



To make sure the future function expansion and upgrading quality, from version v1.6.1, users are only allowed to update system as RAID volume created. What's more, there must be at least 300MB free space of this volume.

2.7.6 System Date and Time Setup

1. Open Internet Explorer and log in to the unit.
2. Click **System / Date/Time**.

Date/Time

Setup

Time Zone

Time Zone: (GMT) Coordinated Universal Time, Greenwich Mean Time: Dublin, Lisbon, London

Date/Time List

Year	2012
Month	10
Day	5
Time	17 : 55 : 30

Daylight Saving Time

Daylight Saving Time: Adjust the clock for daylight saving changes +2 hour(s)

Start Time	<input checked="" type="radio"/> March 25 1:00	<input type="radio"/> January First Sunday 1:00
End Time	<input checked="" type="radio"/> October 28 2:00	<input type="radio"/> January First Sunday 1:00

NTP Setup

Network Time	<input checked="" type="checkbox"/> Enable
Time Server	pool.ntp.org (e.g. pool.ntp.org)
Update Time Interval	Every week Saturday 23:00

3. Choose the time zone.
4. Configure the year, month, day and time manually, or enable NTP server to synchronize time automatically. When NTP server enabled, the date/time settings will be grayed out.
5. Check the **Adjust clock for daylight saving changes** option and select the time change of daylight saving time in your location. Choose the start time and end time of recurrence.
6. Click the **OK** button to restart system to activate the changes.



Clicking the **Update Now** button will save the settings automatically before restarting system.

2.7.7 Restart the Unit

1. Open Internet Explorer and log in to the unit.
2. Click **System / Reboot/Shut down**.

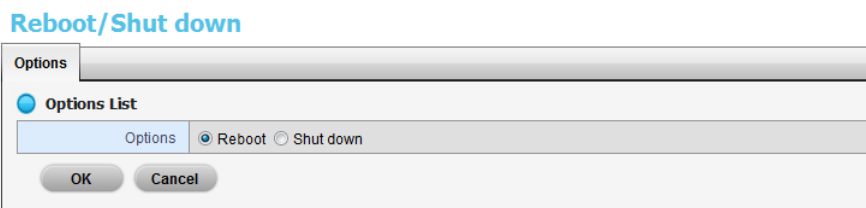

3. Check the **Reboot** option.
4. Click the **OK** button.
5. A confirmation dialog pops up. Click the **OK** button to reboot the unit.

The restart procedure runs automatically. When the unit is fully online:

- The System Status LED turns blue.
- The buzzer beeps one time (if the buzzer is enabled).



During system restart, none of your files will be accessible from your desktops/laptops.

2.7.8 Shut Down the Unit

The only time you need to shut down the unit is to replace the disk drive cooling fan or the power supply. During and after the shut \down, none of your files will be accessible from your desktops/laptops. There are two ways to shut

down the unit.

- **Shut down by Software**

1. Open Internet Explorer and log in to the unit.
2. Click **System / Reboot / Shut down**.

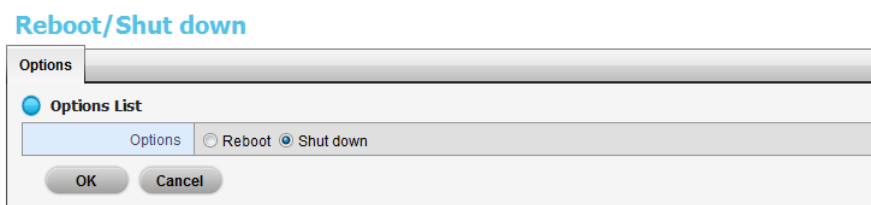

3. Check the **Shut down** option.
4. Click the **OK** button.
5. A confirmation dialog pops up. Click the **OK** button to shut down the unit.

- **Direct Shutdown**

1. Open the lid of the unit.
2. Press and hold the power button for 2 seconds and release your hands when the buzzer is beeping once.
3. System will begin the shutdown process, which takes about 30 seconds to few minutes depends on number of recording channels and other factors.



If the system is crashed and stocked, you can press the power button and hold it for 10 seconds to force to cut off the power directly. We don't recommend to do it if the system work properly.

3.POS

3.1 Introduction

3.1.1 System Introduction

POS, a Point of Sales Systems based on NVS provides financial transaction’s surveillance solution in one central system. The architecture is as below; POS transaction data flows to NVS by Ethernet. Each Cash Register with an external receipt printer is connected by DB9 cable. The transaction information delivered in R232 format can be converted to Ethernet through SCB-C31A POS data capture converter.

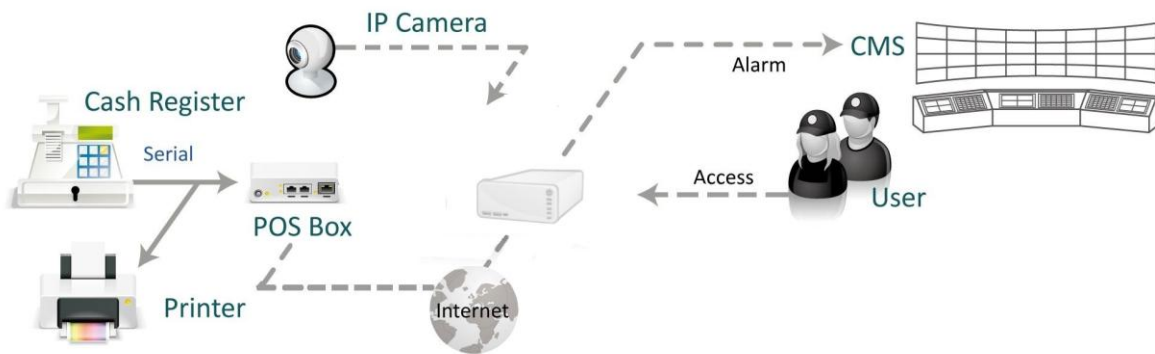

Definition of Terms

Terms	Definition
POS Original Data	Original data from POS. Usually with a lot of symbols and no line feed.
POS Transaction	Filtered result by user-defined tag-filter.

Product Specification

POS Box SCB-C31A	
Input	RS232
Output	Ethernet
DC In	DC +10V to +15V
Power consumption	500 mA
Operating Temperature	-20 to 65°C
Operating Humidity	0-90 % Non-Condensing

Baud Rate	110 bps to 230.4 kbps
Data Bits	5, 6, 7 or 8
Stop Bits	1, 1.5 or 2
Parity	None, Even, Odd, Mark, Space
Flow Control	None, RTX/CTS, XON/XOFF, DTR/DSR

3.1.2 Hardware Installation – SCB-C31A

To connect Cash Register, Printer, and SCB-C31A POS data capture converter together, please follow below steps:

Step 1: Please refer the user manual to setup Cash Register and printer.

Step 2: Using a “Y-shape” DB-9 cable, one DB-9 female connect to POS system and one DB-9 male connect to the receipt printer Y-shape (provided by Printer vendor).

Step 3: Using another DB-9 female connect to SCB-C31A POS Data Capture R232/Ethernet converter with Null modem.



There are two kinds of serial cable: Straight pass-through and Null-Modem. The connection between SCB-C31 POS Data capture box and Y-cable must be null modem (in package).

Step 4: Check the system switch of the SCB-C31A is switched to OFF-OFF position.

Step 5: Connect SCB-C31A with power source.

Step 6: Connect SCB-C31A with internet port by RJ45 LAN cable.

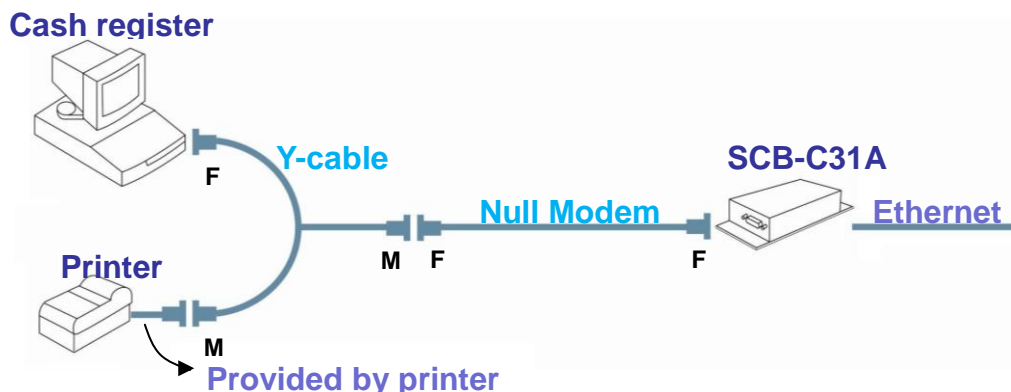

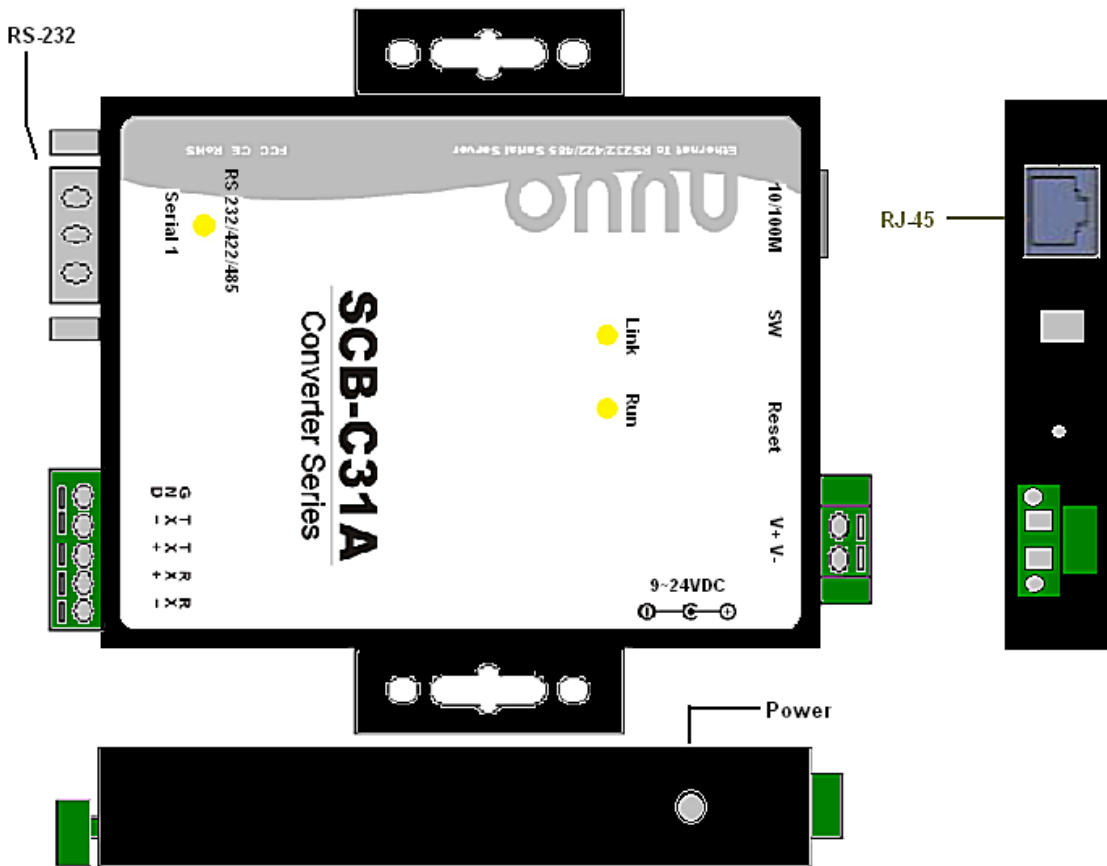

The LED Indicators:

LINK LED: Ethernet cable connection and data active.

RUN LED: System is ready (Blinking).

Serial 1: Transmitting/Receiving Indicator.

3.1.3 Software Installation – SCB-C31A

Step 1: Use IE-browser to setup SCB-C31A, the default IP address is **192.168.1.1**

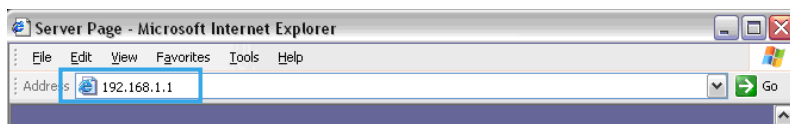

Step 2: Setup IP address and password in **Server** page, and click the **Save** button.



Each time you switch the page of the web, please click Save at first. If you leave this page without saving, all changes will be ignored.

Step 3: Setup Password if needed. Password is only using to activate a security feature on the serial server. Once a password is entered it will be required to access the menu and make change of configuration when access.



Please write down the Serial number and MAC address, these two parameters are necessary when user forget your password.

SCB-C31A Web Configuration - SCB-C31A

Note: If you leave this page without saving, all changes will be ignored!

Server	Server name:	SCB-C31A
Serial Port	Serial number:	00814
Operation	Version & Date:	1.8.30 & 050910
	Password:	
	DHCP:	Enable
	IP address:	192.168.1.29
	Netmask:	255.255.252.0
	Gateway:	192.168.1.1
	MAC address:	00:0B:B4:81:12:B8
	Link status:	100/Full Duplex
	Hardware ID:	FP-1001-A2

Save Default Running Reset

Step 4: Setup according to your POS or Cash Register. Usually all devices are default setting, you can reserve your time to pass this step.

Step 5: Please **restart/reset** the box after changing configurations to active setup.

To reset the unit manually apply power, insert a small plastic tool, and press lightly depressing reset located between the switch. Hold for 3 seconds and release. The Link and Run light will go out and turn back on. The SCB-C31A will revert to the last setting.



Every time you change the configuration of SCB-C31, please check above setting, especially maximum connection and Remote IP address to avoid connection fail.

3.1.4 Connection via TCP Client

If the cash register possess network, please install system according to following diagram and purchase a POS license to activate this function.

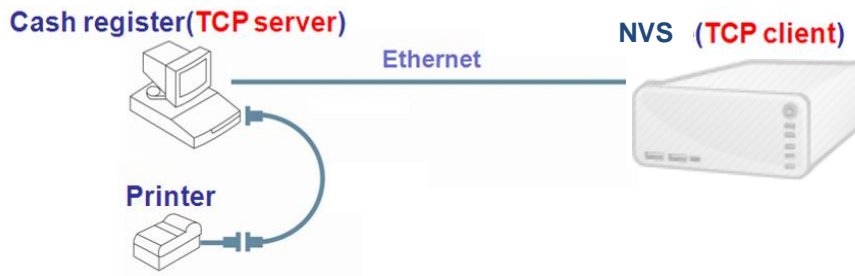

3.2 Software Setup

3.2.1 Activate POS License

If you are not the SCB-C31 user, you need to activate POS license before starting the following settings, please refer to **License Activation** for details.



3.2.2 NVR POS Setting

1. Open Internet Explorer and log in to the unit.
2. Click **POS & I/O / POS Settings**.

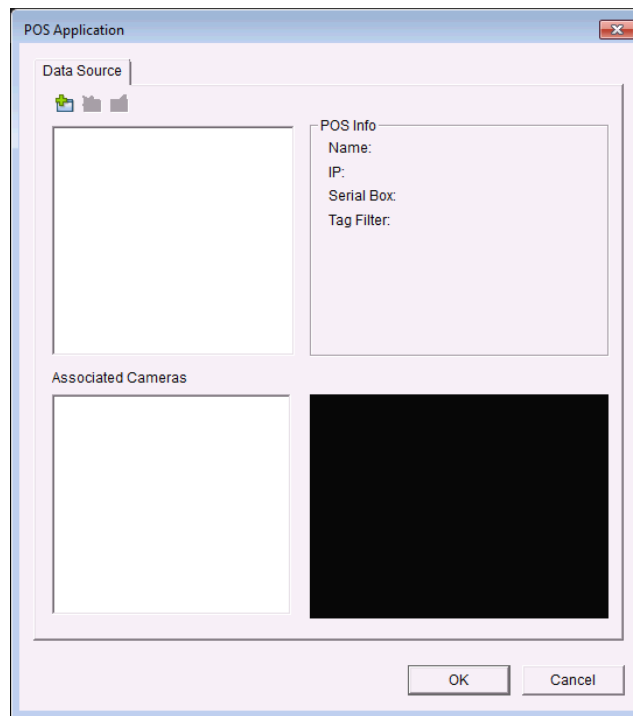

3. Click the **Settings** tab to set POS application.



- **Data Source:** List of all the data sources.
 -  **Insert:** Click to insert POS and do the POS settings. See **Insert POS Setting** for details.
 -  **Delete:** Click to remove the selected POS from the list. See **Delete POS Device** for details.
 -  **Configure:** Click to configure the selected POS and modify the POS settings. See **Configure POS Setting** for details.
- **POS info:** The setting information of the selected POS on this window.
 - **Name:** Name of the POS data source.
 - **IP:** IP of the POS data source.
 - **Serial Box:** The serial box data source used.
 - **Tag Filter:** Tag type to filter the data from POS. See **Tag Filter** for details.
- **Associated Cameras:** List of all the associated cameras of the selected POS.

4. Click the OK button to finalize the modification.

3.2.3 Insert POS Setting

1. Click  **Insert** button to open the **POS Setting** window.
2. Set up basic data source, including **Name**, **Model**, **IP address**, and **Port**. There are three types of models.

- **SCB-C31**: The device possesses one POS license, and should be equipped with the cash register not working as TCP server.
- **SCB-C31A**: The difference from SCB-C31 is not possessing one POS license, so user should activate POS license.
- **TCP Client**: Cash register possesses with network, so no need to have SCB-C31A as a converter. POS license is needed.

3. After setting, click **Test Connection** to test POS device connection.

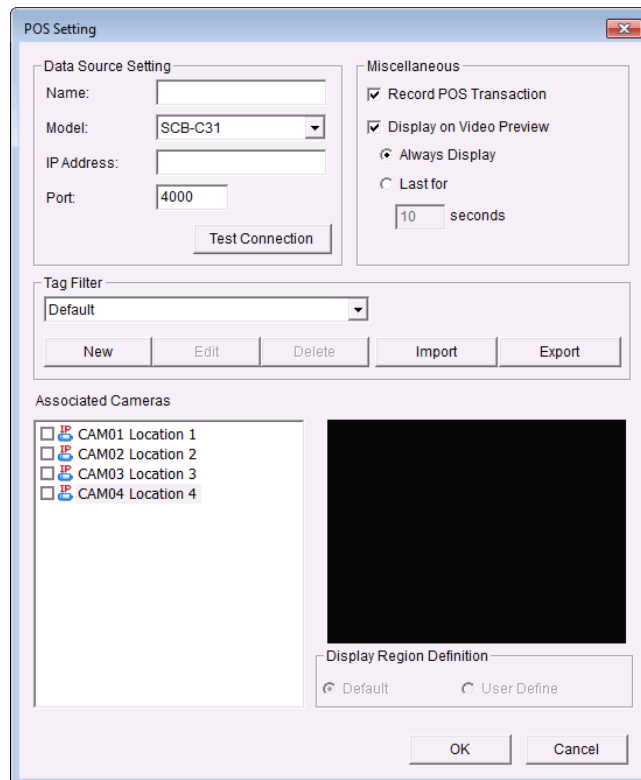

4. Set up Miscellaneous options, including **Record POS Transaction** and **Display on Video Preview**.

- **Record POS Transaction**: Select this checkbox to record POS transaction data. Users are allowed to search the POS data.
- **Display on Video Preview**: Select this checkbox to display POS transaction overlay on associated camera live video. Two types of transaction data display time:
 - **Name**: Name of the POS data source.
 - **Always**: Keep transaction data on video until receiving next transaction date.
 - **Last for ___ seconds**: Each transaction data only lasts on video for ___ seconds after receiving the last data of transaction.

5. Select **Tag Filter**. See **Tag Filter** for details.
6. Select the camera of **Associated Cameras** to display POS transaction data overlay on live video.
7. Set up display area for each camera video in **Display Region Definition**.
 - **Default**: The default display area is in the upper left corner of video image.
 - **User Define**: Enable **User Define**, and define display area by dragging rectangle
8. Click the **OK** button to save.

3.2.4 Delete POS Device

1. Choose POS device.
2. Click  **Delete** button to remove this POS device from the system.



3.2.5 Configure POS Setting

1. Choose POS device.
2. Click  **Configure** button to open the POS Setting window.
3. Refer to **Insert POS Setting** to modify configuration.

3.3 Tag Filter

The original transaction data from POS system is hard to read. Users can define filters to make the POS strings meaningful. The system also provides a simple default tag filter to filter out same common EPSON commands, users can base on this default tag filter to edit their customized filters.

3.3.1 Add New Tag Filter

1. Click  **Insert** button or choose a device and click  **Configure** button to open the **POS Setting** window.
2. Click **New** to open tag filter window.
 - **General**: Name of Tag Filter and Connect button.
 - **Original Data**: Original transaction data from POS device.
 - **Filtered Data**: Filtered data after definition.
 - **Filter Function**: Tool used for defining filter type.
 - **Filter List**: List of all filters.
 - **Data Tool**: Clear/import/export buttons to clear/import/export the

original and filtered data.

- **Filter Tool:** Upper/down buttons to arrange the priority of each filter; remove button to remove the filter from list.

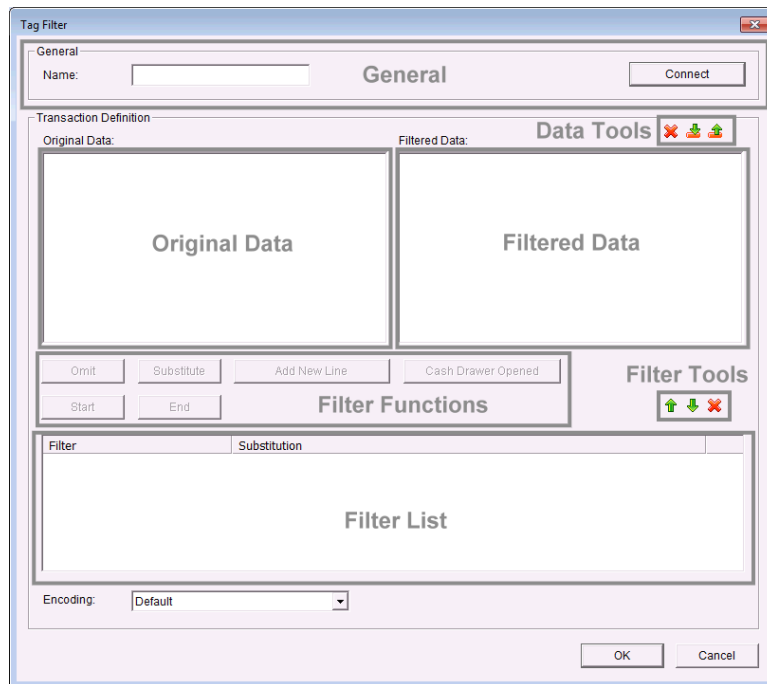

3. Enter name of this tag filter.
4. Click **Connect** button to capture POS transaction data from POS device. The original transaction data will be shown on the left window.



If you don't want the data keep importing when editing filter, click **Disconnect** button to stop connecting.

5. Data Tools

- **Clear:** Remove data from Original Data window and Filtered Data window.
- **Import:** Reload exported binary data.
- **Export:** Capture and export original binary data.

6. Start to edit tag filters. Click and drag to select text from Original Data window, and then use the below six buttons to define filters. The filtered transaction data will be shown on the right window.

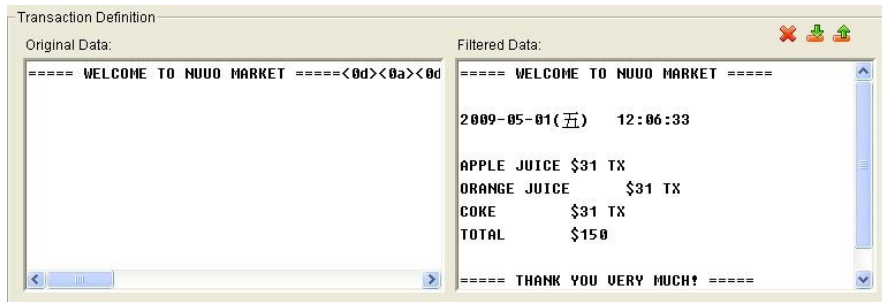

- **Omit:** Neglect the selected text which is meaningless or not important. The text will disappear on the right window.



- **Substitute:** Use another word(s) to replace the selected text. The system will pop up a substitution panel for replacing word(s) users want. The replaced text will be shown on the right window.



- **Add New Line:** Define the selected text as the symbol for changing to new line. The result will be shown on the right window.

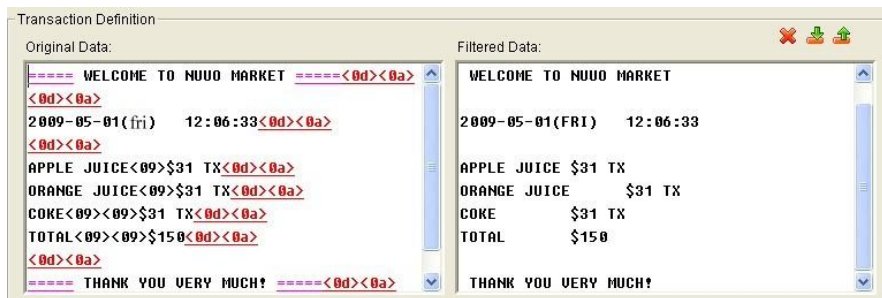

- **Start:** Define the selected text as the symbol for transaction beginning. The filtered data will be separated line as below.



- **Cash Register Opened:** Define the selected text as the symbol for opening cash register. The filtered data will be shown the **<Cash Drawer Open>** mark as below.

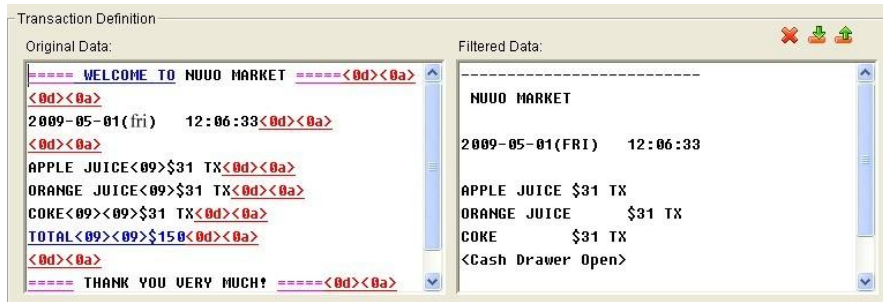

- **End**: Define the selected text as the symbol for transaction ending. The filtered data will be separated line as below.

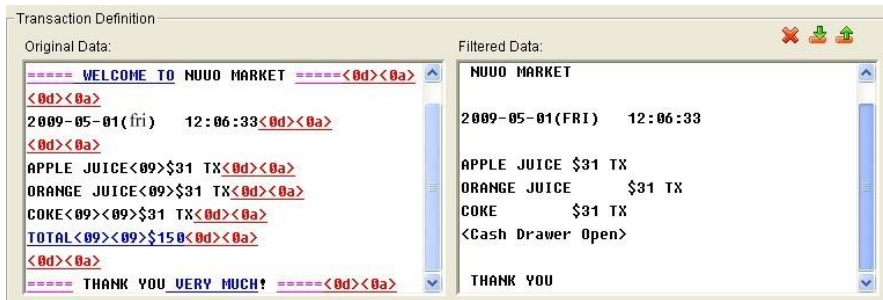

7. Filter Tools

- **Up**: Move a tag filter up; the upper filter will be operated earlier.
- **Down**: Move a tag filter down; the lower filter will be operated later.
- **Delete**: Remove a filter from this tag filter list.

Filter	Substitution
=====	
fri	FRI
<0d><0a>	<New Line>
WELCOME TO	<Transaction Start>
TOTAL<09><09>\$150	<Cash Drawer Open>
VERY MUCH	<Transaction End>

8. Click the **OK** button to save.

3.3.2 Edit Tag Filter

1. Select Tag Filter name from drop-down menu.
2. Click **Edit** button.
3. Configure the Tag Filter window.
4. Click the **OK** button to save.

3.3.3 Delete Tag Filter

1. Select Tag Filter name from drop-down menu.

2. Click **Delete** button to delete it.

3.3.4 Import/Export Tag Filter

1. Click **Import/Export** button and select Import/Export URL.
2. Click **Open/Save** to Import/Export Tag Filter.
3. After importing tag filters, users can simply select tag filter from drop-down menu without editing new tag filter.

3.4 POS Display Font

The system allows users to set up the fonts of POS transaction data on live view video and playback video.

3.4.1 Live View

1. Open Internet Explorer and log in to the unit.
2. Click the **Live View**.
3. Click the **General Setting** button to open **Live View Setting** window.

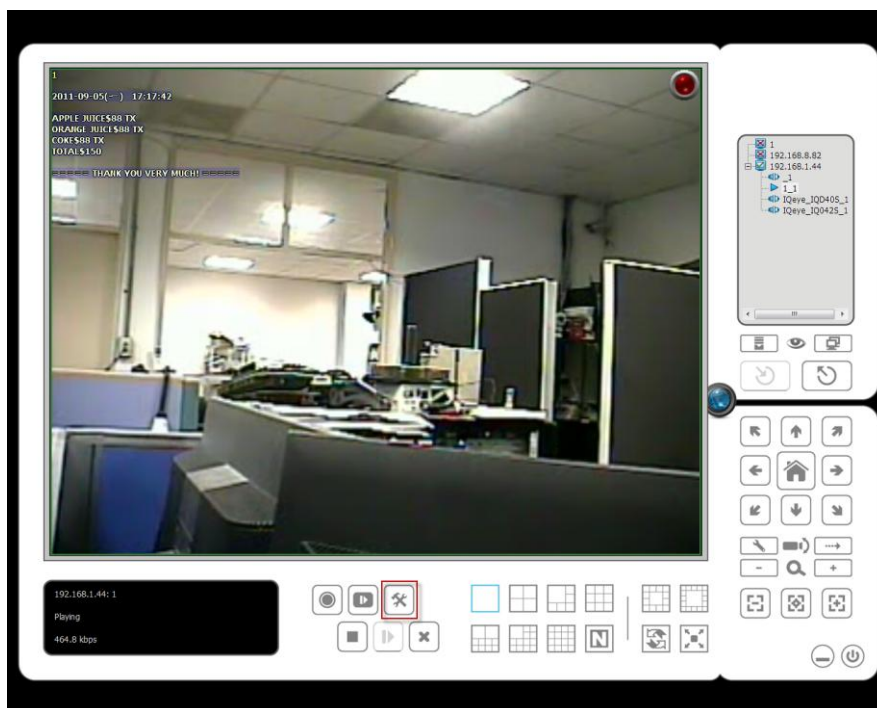

4. Select the font, font size, font color and background for the POS transaction data overlaid the video.

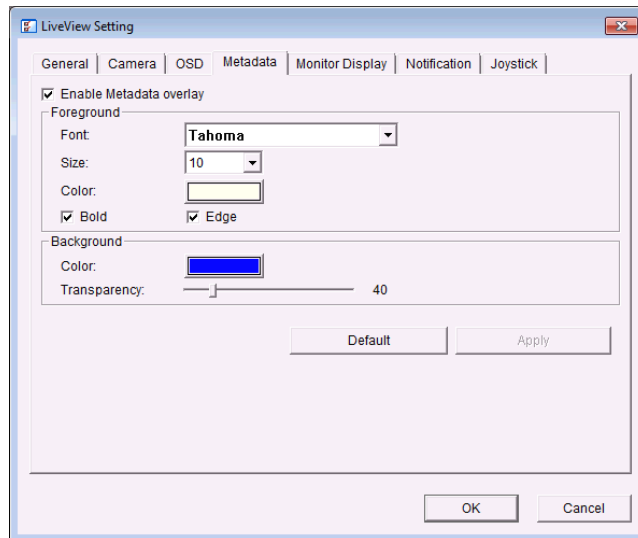

5. Click the **OK** button to save.

3.4.2 Remote Live Viewer

1. Startup > NVS > Remote Live Viewer
2. Click the **General Setting** button to open **Live View Setting** window.

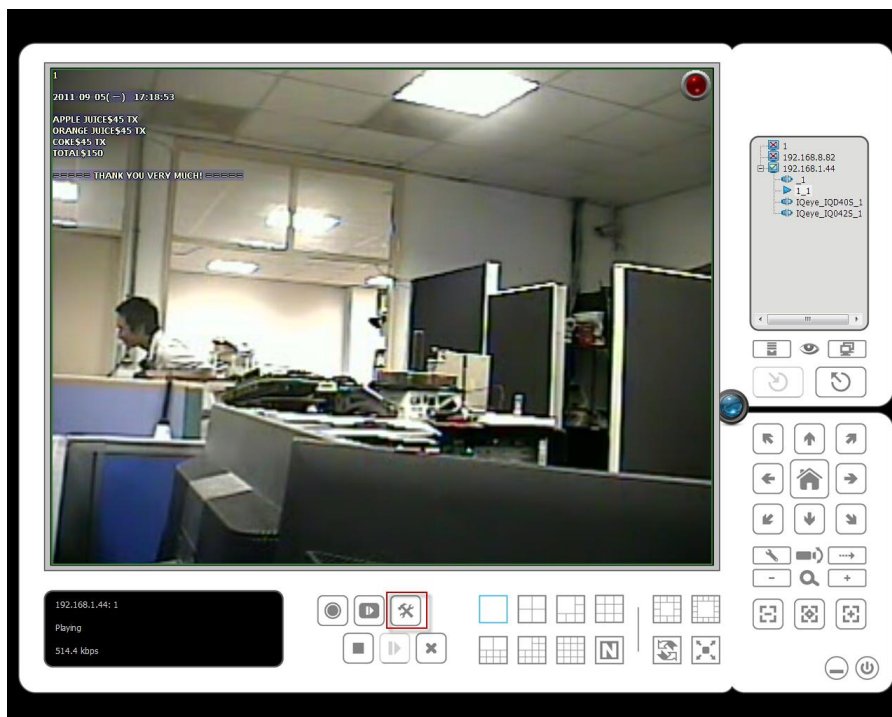

3. Select the font, font size, font color and background for the POS transaction data overlaid the video.

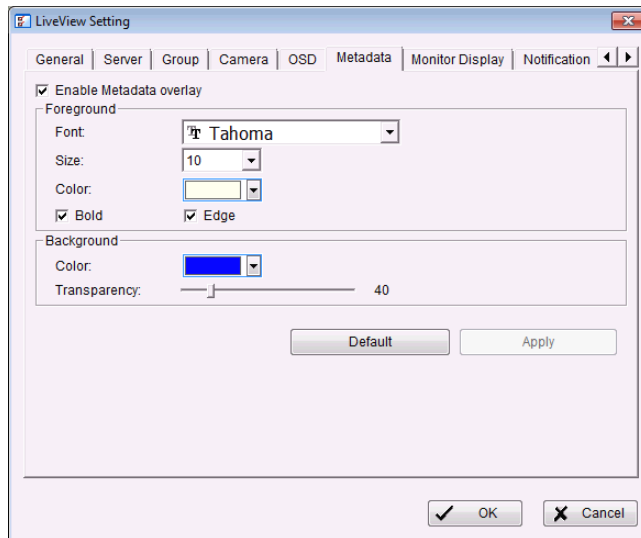

4. Click the **OK** button to save.

3.4.3 Playback

1. Open Internet Explorer and log in to the unit.
2. Click the **Playback** button.
3. Click the **Setting** button to open **Setting** window.

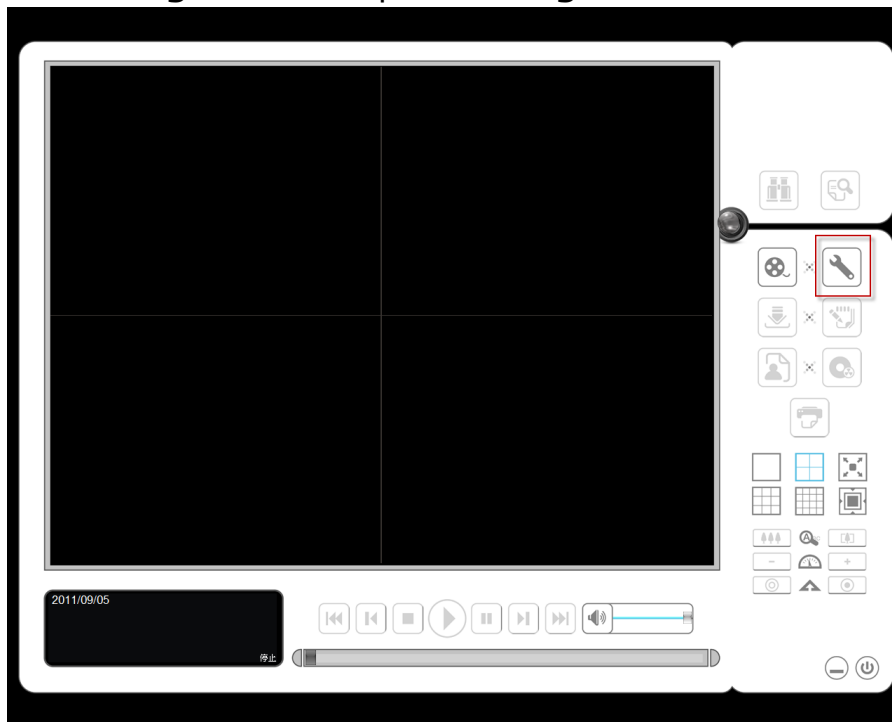

4. Select the font, font size, font color and background for the POS transaction data overlaid the video. Also, select the type of transaction data display time.

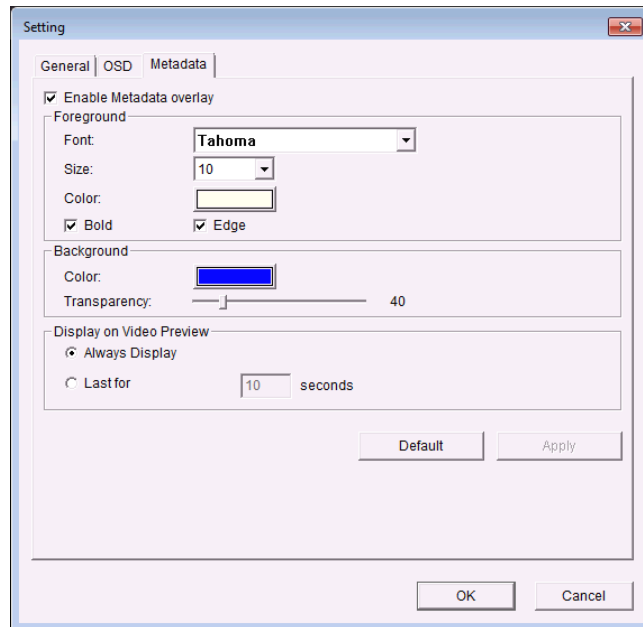

3.4.4 Playback System

1. Startup > NVS > Playback System
2. Click the **Setting** button to open **Setting** window.

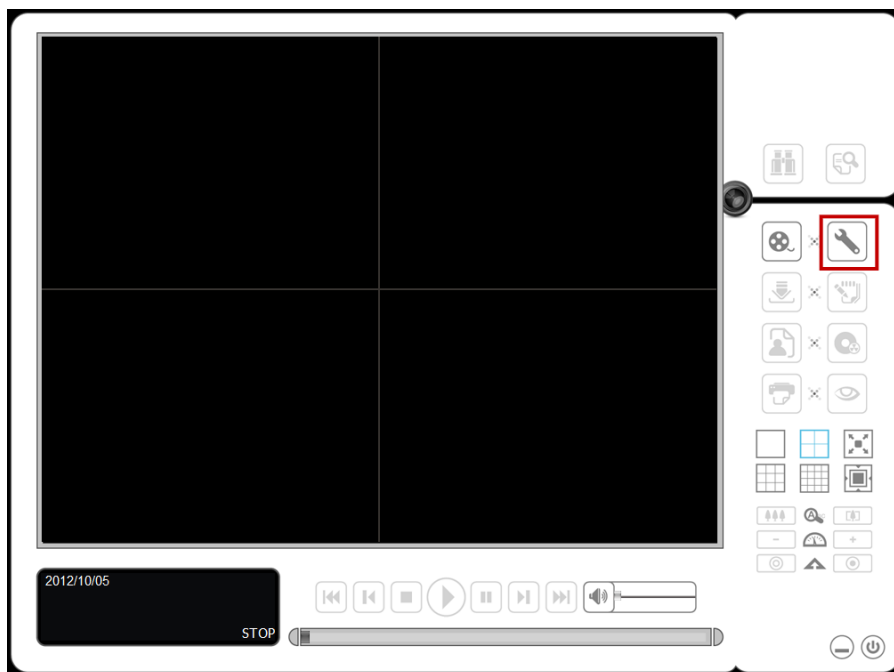

3. Select the font, font size, font color and background for the POS transaction data overlaid the video. Also, select the type of transaction data display time.

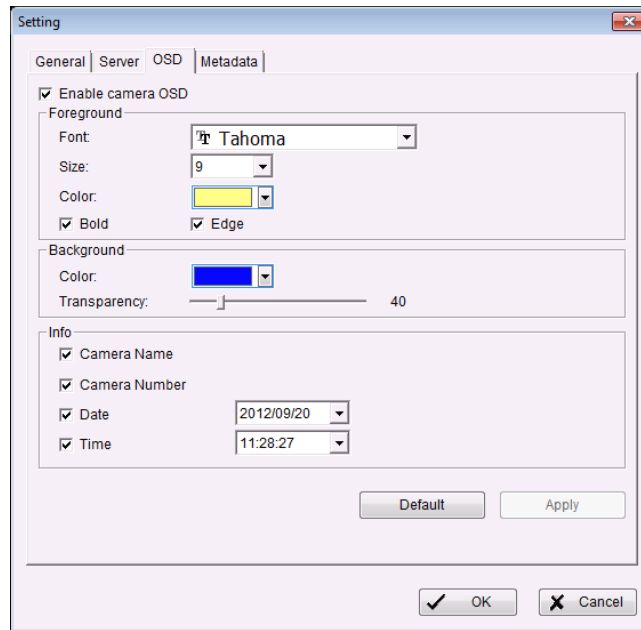

3.5 POS Transaction Data Search

POS Search tool is used to search key word of all transaction data.

3.5.1 Search POS Transaction Data through Playback

1. Open Internet Explorer and log in to the unit.
2. Click the **Playback** button.
3. Click the **Open Record** button to open **Data Time Search Dialog** window.

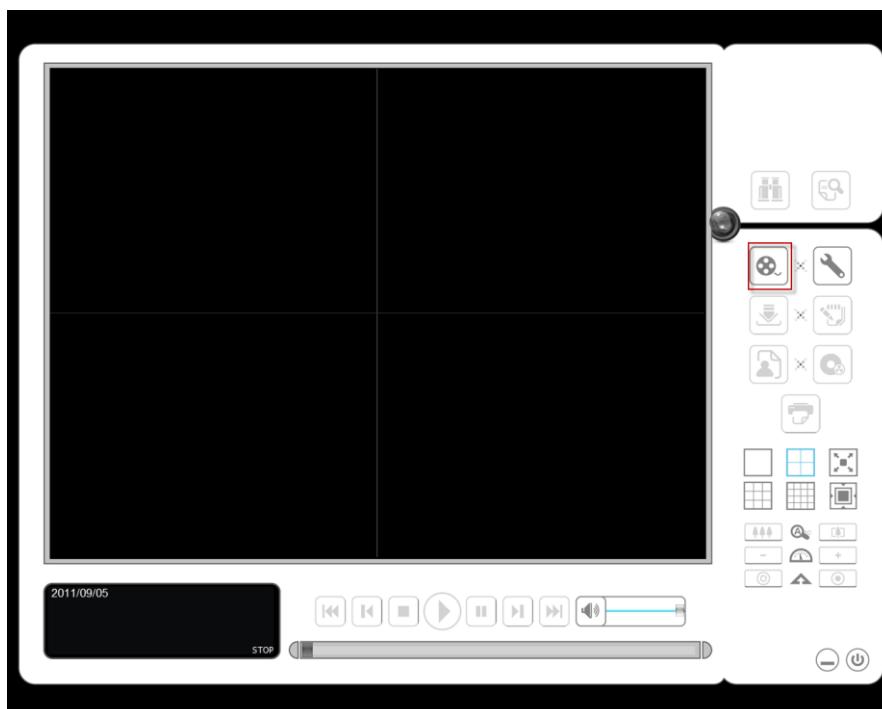

- Click the **POS Search** button  to open **POS Search Dialog** window.

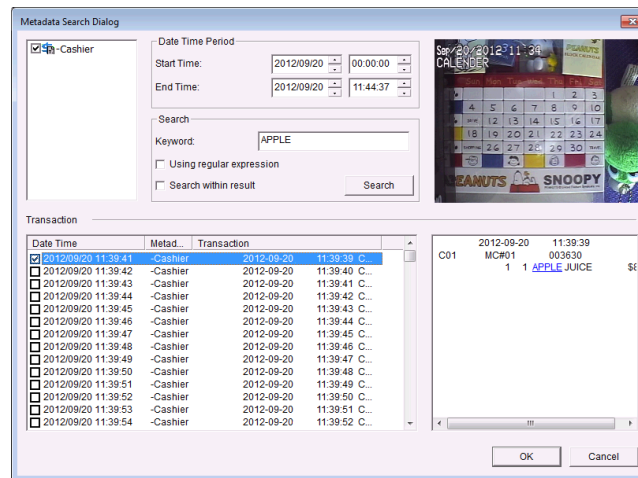

- Select a POS device(s) from the POS list.
- Set up Start Time and End Time in **Data Time Period** section.
- Enter the keyword you want to search.
- Click the **Search** button, the results will be shown in Transaction table.
- Select an item from Transaction table, the transaction detail will be shown in the table of lower right corner, and the recorded video of associated camera will be shown in the upper right corner.
- Select the checkbox of **Search within result**, and enter a keyword, you can search the data within the results.

3.5.2 Search POS Transaction Data through Playback System

- Startup > NVS > Playback System.
- Click the **Open Record** button to open **Data Time Search Dialog** window.
- Click the **Remote Server Site**  icon on the top of the window to select the server users want to access.
- Follow the step 4 through 10 of **Search POS Transaction Data by Playback** to search the data.

3.6 Playback Video with POS Data

Enable POS overlay in **Setting** window to view recorded video with POS transaction data (Refer to **POS Display Font**). If the option is enabled, the system will auto display transaction data when playing recorded video. There are two modes to select video period.

3.6.1 Select Period by POS Search

1. Refer to **POS Transaction Data Search**.
2. Select the transaction data from the result list, and click **OK**.

Date Time	Metad...	Transaction	
<input checked="" type="checkbox"/> 2012/09/20 11:39:41	-Cashier	2012-09-20 11:39:39 C...	
<input type="checkbox"/> 2012/09/20 11:39:42	-Cashier	2012-09-20 11:39:40 C...	
<input type="checkbox"/> 2012/09/20 11:39:43	-Cashier	2012-09-20 11:39:41 C...	
<input type="checkbox"/> 2012/09/20 11:39:44	-Cashier	2012-09-20 11:39:42 C...	
<input type="checkbox"/> 2012/09/20 11:39:45	-Cashier	2012-09-20 11:39:43 C...	
<input type="checkbox"/> 2012/09/20 11:39:46	-Cashier	2012-09-20 11:39:44 C...	
<input type="checkbox"/> 2012/09/20 11:39:47	-Cashier	2012-09-20 11:39:45 C...	
<input type="checkbox"/> 2012/09/20 11:39:48	-Cashier	2012-09-20 11:39:46 C...	
<input type="checkbox"/> 2012/09/20 11:39:49	-Cashier	2012-09-20 11:39:47 C...	
<input type="checkbox"/> 2012/09/20 11:39:50	-Cashier	2012-09-20 11:39:48 C...	
<input type="checkbox"/> 2012/09/20 11:39:51	-Cashier	2012-09-20 11:39:49 C...	
<input type="checkbox"/> 2012/09/20 11:39:52	-Cashier	2012-09-20 11:39:50 C...	
<input type="checkbox"/> 2012/09/20 11:39:53	-Cashier	2012-09-20 11:39:51 C...	
<input type="checkbox"/> 2012/09/20 11:39:54	-Cashier	2012-09-20 11:39:52 C...	

3. The period you select from POS search results will be selected automatically.

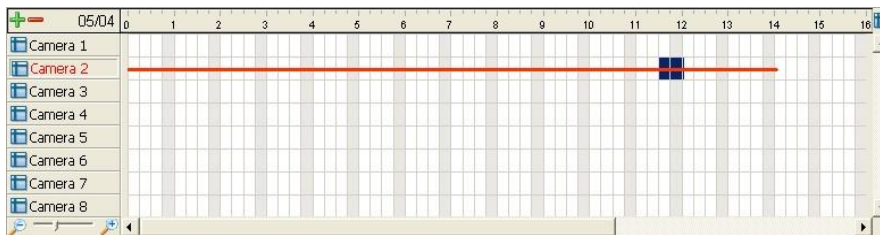

4. Click **OK** to playback videos.

3.6.2 Select Period by Data & Time through Playback

1. Open Internet Explorer and log in to the unit.
2. Click the **Playback** button.
3. Click the **Open Record** button to open **Data Time Search Dialog** window.
4. Highlight the video clip you want to review by left-clicking and dragging the time period. You may also utilize the Start Time and End Time in **Date Time Period** section after choosing cameras.
5. Click **OK** to playback videos.

3.6.3 Select Period by Data & Time through Playback System

1. Startup > NVS > Playback System.
2. Click the **Open Record** button to open **Data Time Search Dialog** window.
3. Click the **Remote Server Site**  icon on the top of the window to select the server users want to access.

4. Highlight the video clip you want to review by left-clicking and dragging the time period. You may also utilize the Start Time and End Time in **Date Time Period** section after choosing cameras.
5. Click **OK** to playback videos.

3.7 Backup Video with POS Data

There are three ways to backup video with POS transaction data.

3.7.1 Backup through Internet Explorer

1. Open Internet Explorer and log in to the unit.
2. Click the **Open Record** button to select data.
3. Click the **Backup** button.

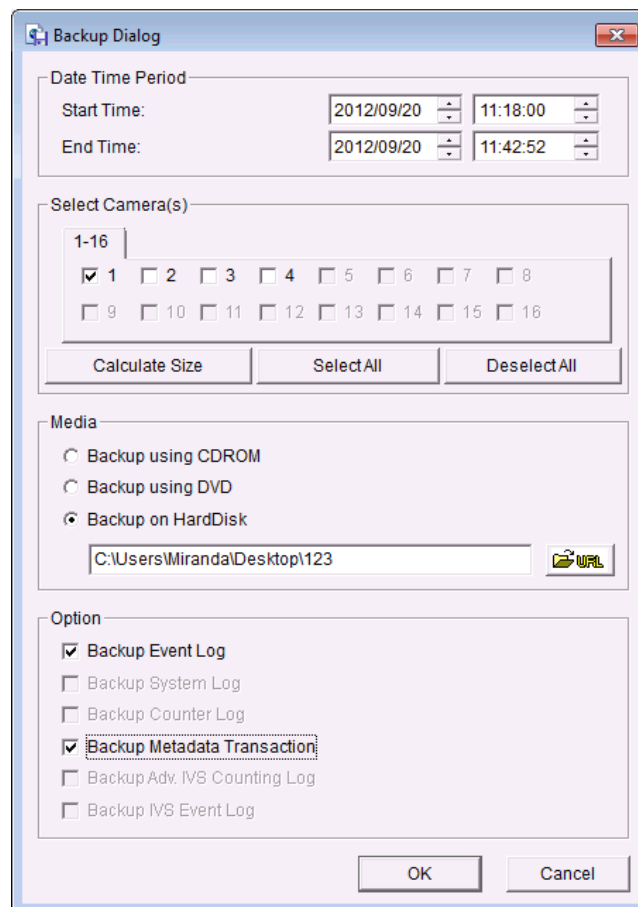

4. Check the **Backup POS Transaction** option.
5. Set the Start Time and End Time you want to backup.
6. Select the cameras you want to backup.
7. Select the directory you want to save the backup data.
8. Click the **Backup** button.

9. The system will then begin backup process automatically.

3.7.2 Backup through Playback System

1. Startup > NVS > Playback System.
2. Click the **Open Record** button to select data.
3. Click the **Backup** button.
4. Check the **Backup POS Transaction** option.
5. Set the Start Time and End Time you want to backup.
6. Select the cameras you want to backup.
7. Select the directory you want to save the backup data.
8. Click the **Backup** button.

3.7.3 Backup through Backup System

Please refer to step 1 to 14 of the content of **Backup and Delete Records**, and check the **Backup POS Transaction** option.



4. Live view

There are two ways to execute the live view function: with Internet Explorer or with the **Remote Live Viewer** application.

4.1 Internet Explorer

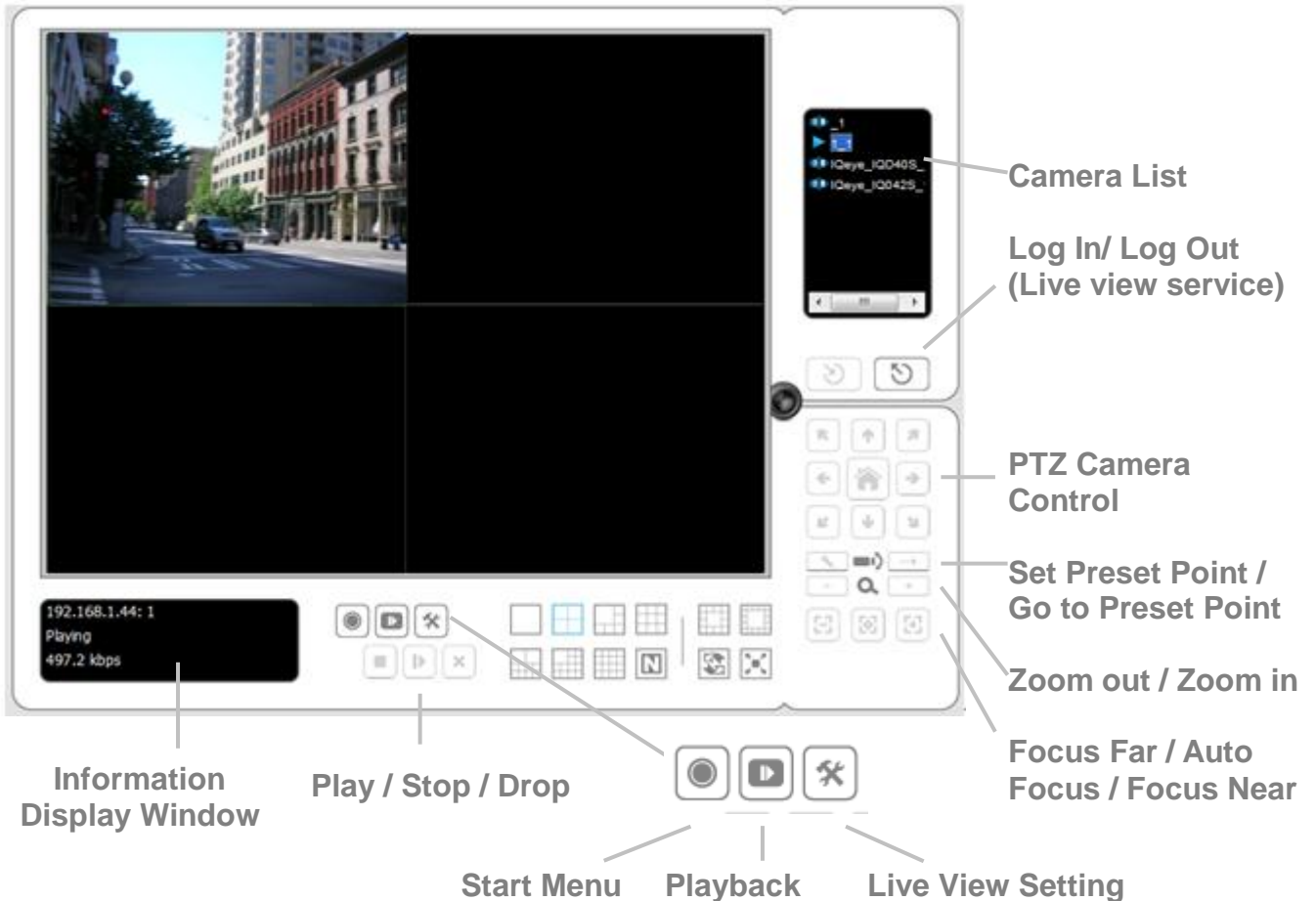
4.1.1 Live View Control Panel



- **PTZ Camera Control:** You may control the camera view by using the PTZ camera control panel to adjust the camera's view. This is only available with cameras that support the PTZ function.
- **Set Preset Point / Go to Preset Point:** Adjust the camera view and click the  button to set up this view as preset point. Repeat the process to add more preset points. Click the  button to see the preset view.
- **Zoom:** Click the **+** or **-** button to zoom in or zoom out the view.
- **Play / Stop / Drop:** Select a camera / video and click this button to play/stop/disconnect a particular channel.
- **Information Display Window:** Display video information including

- server name, video current status, and bit rate for a selected channel.
- **Start Menu > E-Map**: Upload map and drag camera or I/O on it to track device location and alarm status with instant response when an event occurred. See details in the chapter of **E-Map**.
- **Start Menu > I/O Control Panel**: Utilize I/O device function remotely. User can remotely adjust the Output Pins by turning it on or off.

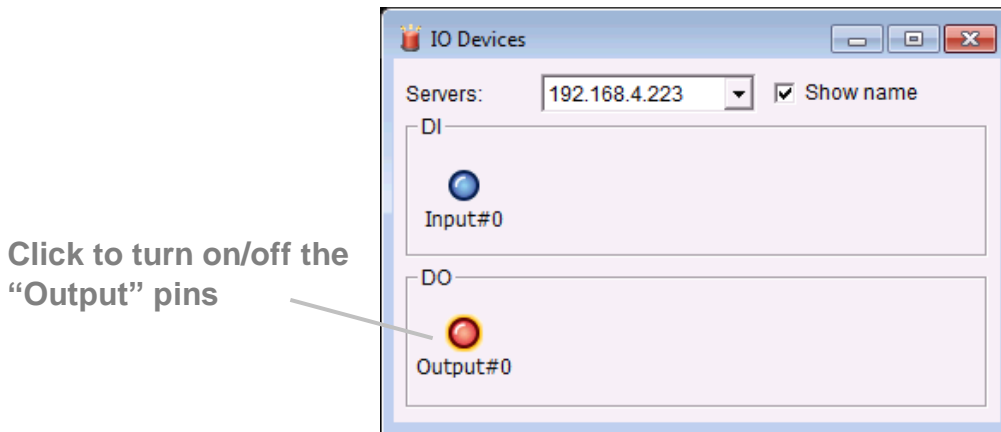

- **Playback**: View playback video remotely.
- **Auto Scan**: Activate auto scan to rotate the channels on the display screen. For instance, you may select to show only 4-split screen on the liveview, while connecting 16 channels to the system. With auto scan function, you are able to see all 16 channels by turns.
- **Layout**: Click to change the multiple-split layout.

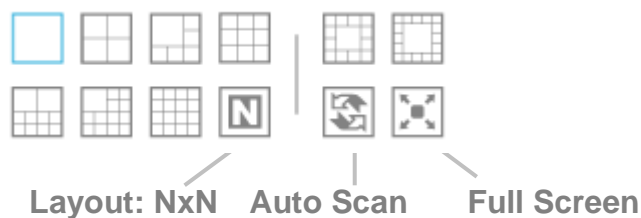

You can right click on the camera screen to enable the following function.

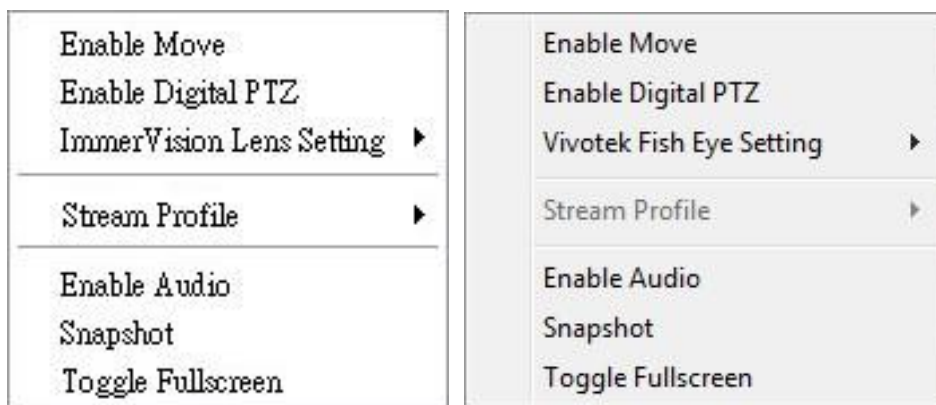

- **Enable Move**: Adjust the current view of camera which supports PT function by dragging the  button on the display screen.
- **Enable Digital PTZ**: Click the + or – button to zoom in or zoom out the view. The lower right square flashing on the video grid indicates the correspondent view of the camera.
- **ImmerVision Lens Setting**: Select the mode of lens, original, PTZ mode, Quad mode and Perimeter mode.
- **Vivotek Fisheye Setting**: Select the mode of lens, Original, Rectilinear mode, Full-view panorama mode, Dual-view panorama mode. Type of modes depends on lens location.
- **Stream Profile**: Select the stream profiles, original, low, minimum.
- **Enable Audio**: Enable audio on active channel(s).
- **Snapshot**: Select the snapshot function to capture a specific video image immediately.
- **Toggle Fullscreen**: Select it to view cameras with full screen. Press “Esc” or right click un-select full screen to go back to the original view.

Also, right click on camera list to duplicate and connect/disconnect designate cameras, and do other functions.



- **Duplicate Camera**: Select the duplicate camera function to create multiple views. The duplicated camera will be shown with green indicator as the right picture. Combine this function with digital PTZ, users are allowed to enlarge different spots and view them in different channels without failing to record the whole view.
- **Connect / Disconnect**: Click to connect or disconnect the designate camera.
- **Login / Logout Server**: Click to login or logout.
- **Connect All / Disconnect All**: Click to connect or disconnect all cameras.

4.1.2 Live View Setting

1. Open Internet Explorer and log in to the unit.
2. Set the cameras.
3. Click the **Live View** button on the top of the page.
4. Select a camera(s) from the camera list on the right and then drag it to where you wish the image to be displayed.

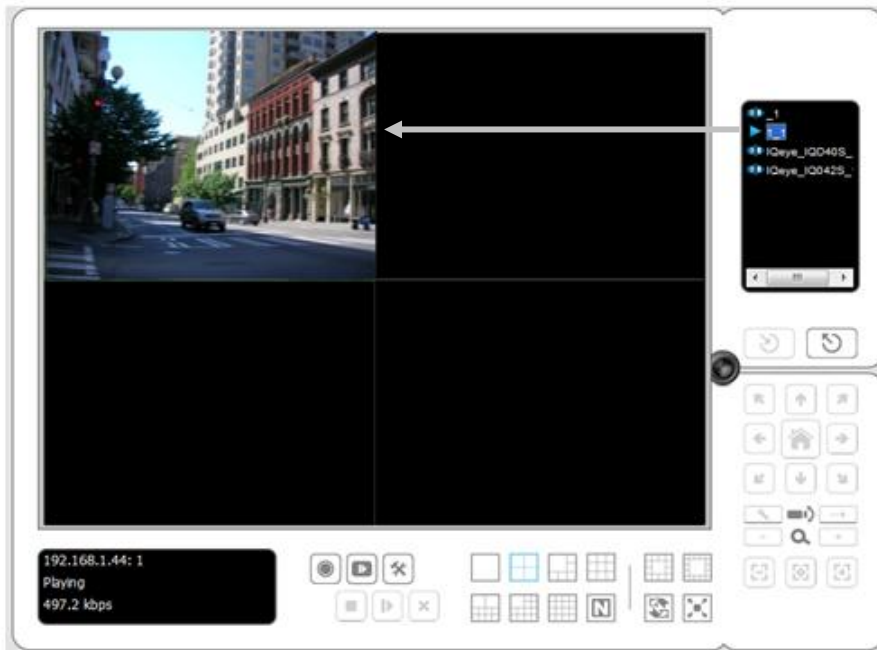

When running Internet Explorer, do not use the function "Open in New Window". Using this function may cause Internet Explorer to become unstable.

4.1.3 General Setting

1. Open Internet Explorer and log in to the unit.
2. Click the **Live View** button on the top of the page.
3. Click the **General Setting** button.
4. Click the **General** tab.

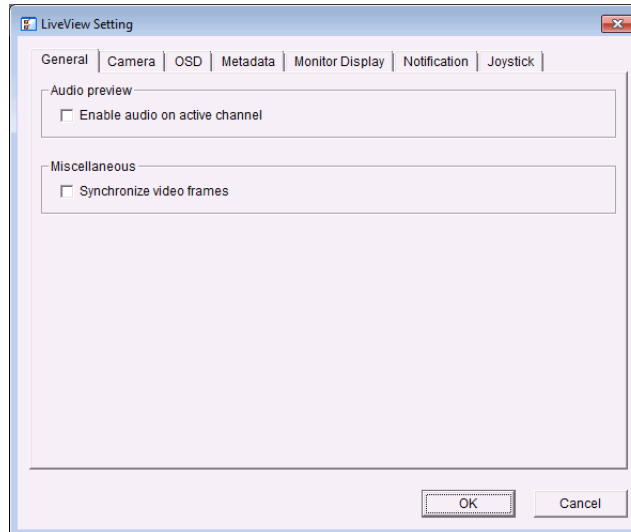

5. Check the **Enable audio on active channel** option to enable audio streaming on active channel. This function synchronizes with right click on camera to enable audio.
6. Check **Synchronize video frames** to avoid the tearing problem occurring in video display while increasing the CPU loading.
7. Click the **OK** button.

4.1.4 Stream Profile Setting

Select the preferred stream type of each camera as default live view profile.

1. Open Internet Explorer and log in to the unit.
2. Click the **Live View** button on the top of the page.
3. Click the **General Setting** button.
4. Click the **Camera** tab.

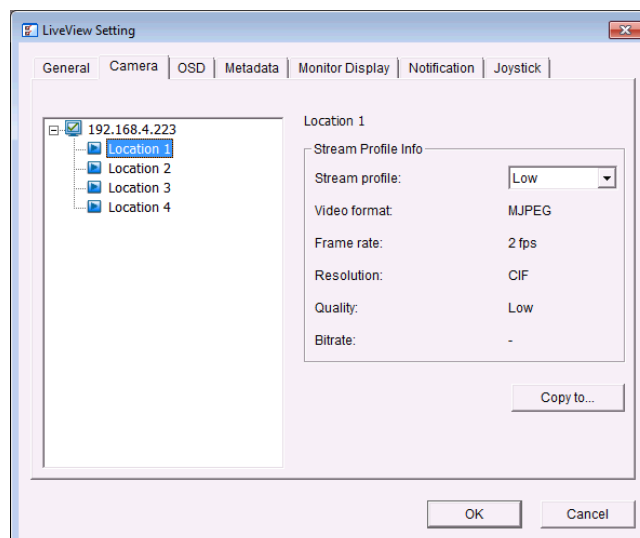

- Adjust the stream profile of every camera with stream profile enabled in the **setting page**.
- Click a camera and select its stream profile, and click the **Copy to...** button to apply this profile to other channels.
- Click the **OK** button.

4.1.5 OSD (On-screen display) Setting

- Open Internet Explorer and log in to the unit.
- Click the **Live View** button on the top of the page.
- Click the **General Setting** button.
- Click the **OSD** tab.

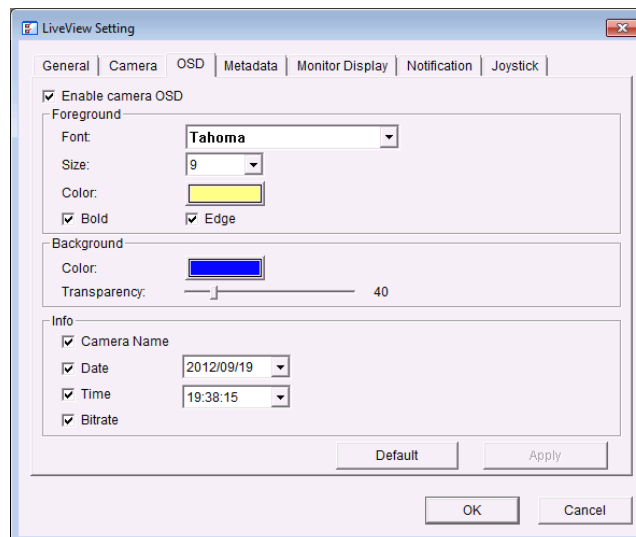

- Check the **Enable camera OSD** option.
- Set the foreground and background settings of the OSD.
- Select which kinds of information will be displayed on the screen.
- Click the **Apply** button to preview the result.
- Click the **Default** button to back to the default settings if necessary.
- Click the **OK** button.

4.1.6 Monitor Display Setting

- Open Internet Explorer and log in to the unit.
- Click the **Live View** button on the top of the page.
- Click the **General Setting** button.
- Click the **Monitor Display** tab.

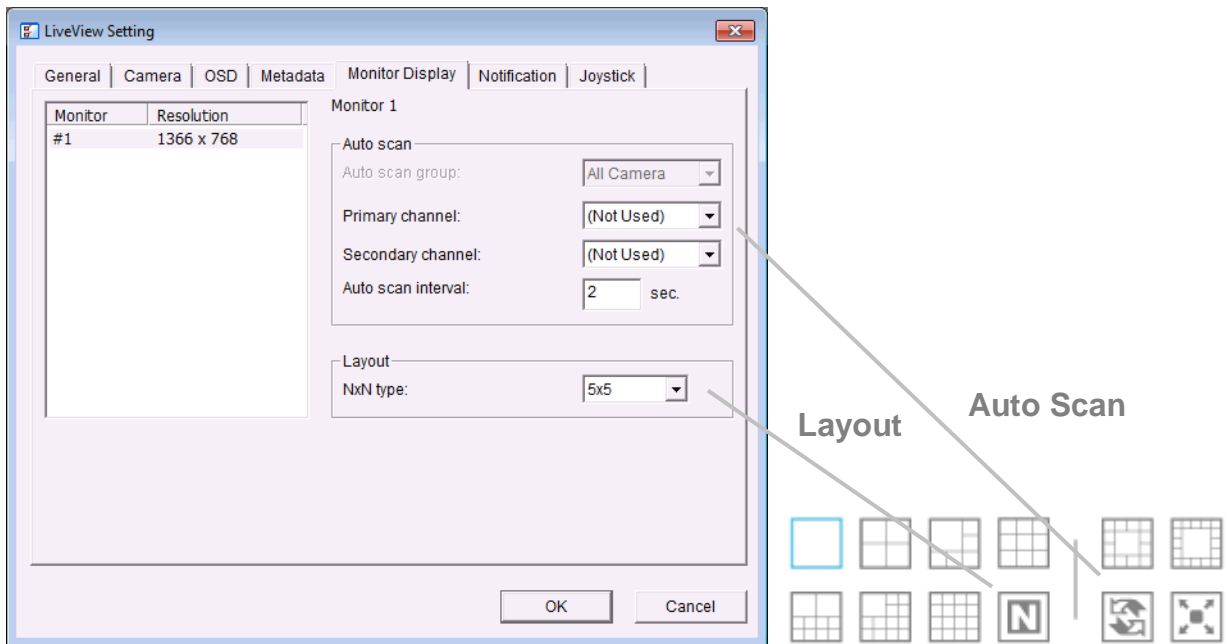

5. Select **Primary channel** which will always be on the screen when activating auto scan; while select **Secondary channel** which has second priority when activating auto scan. Enter the time interval for auto scan.
6. Select the screen division of NxN type.
7. Click the **OK** button.

4.1.7 Notification

1. Open Internet Explorer and log in to the unit.
2. Click the **Live View** button on the top of the page.
3. Click the **General Setting** button.
4. Click the **Notification** tab.

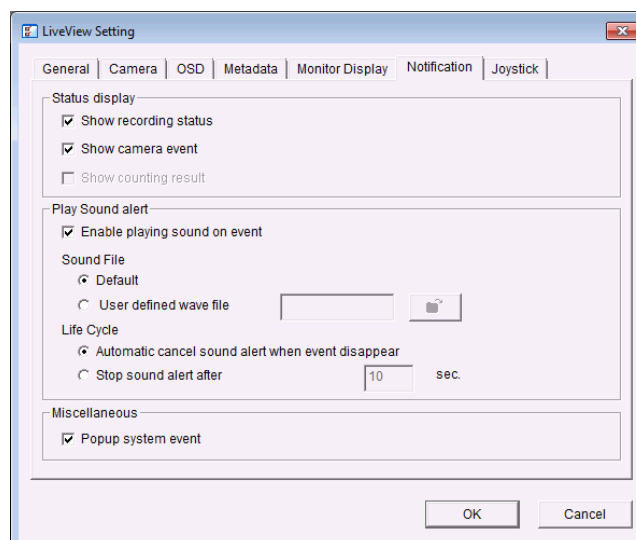

5. Check **Show recording status** to show the crystal ball with recording status on monitor display.
6. Check **Show camera event** to display the words of detected camera event on the correspondent screen.
7. Check the **Enable playing sound on event** option. Select sound file, default sound or user defined sound (.wav), and define the cycle.
8. Check **Popup system event** to pop up system event message dialog as a warning when a system event occurred.
9. Click the **OK** button.



The function only activates on event, which means you have to setup camera motion, camera I/O and I/O Box I/O as an event. Refer to **Event & Action Management** to do the setting.

4.1.8 Set up Joystick Control

1. Open Internet Explorer and log in to the unit.
2. Click the **Live View** button on the top of the page.
3. Click the **General Setting** button.
4. Click the **Joystick** tab.

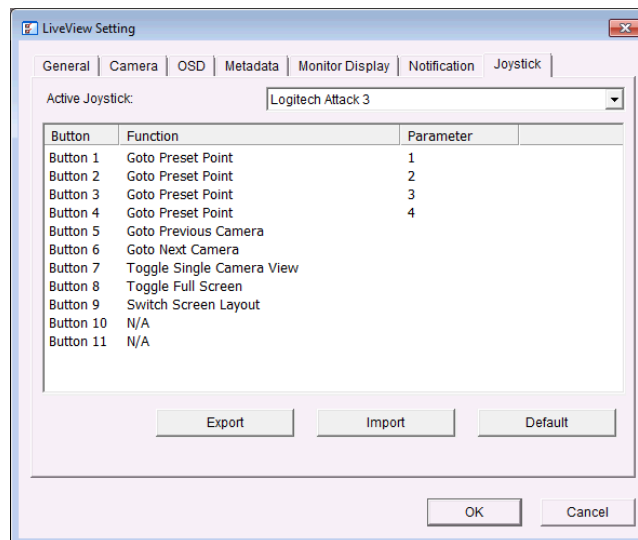

- **Function:** You can choose the function from the drop-down menu for the button of the joystick.

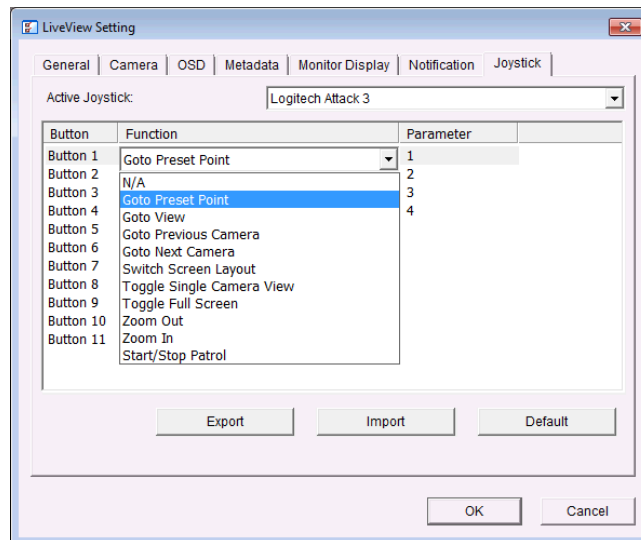



- **Parameter:** Choose the preset point from the drop-down menu.
- **Default:** Click to back to default setting.
- **Import:** Click to import the settings.
- **Export:** Click to export the settings.

5. Click the **OK** button.

4.2 Remote Live Viewer Application

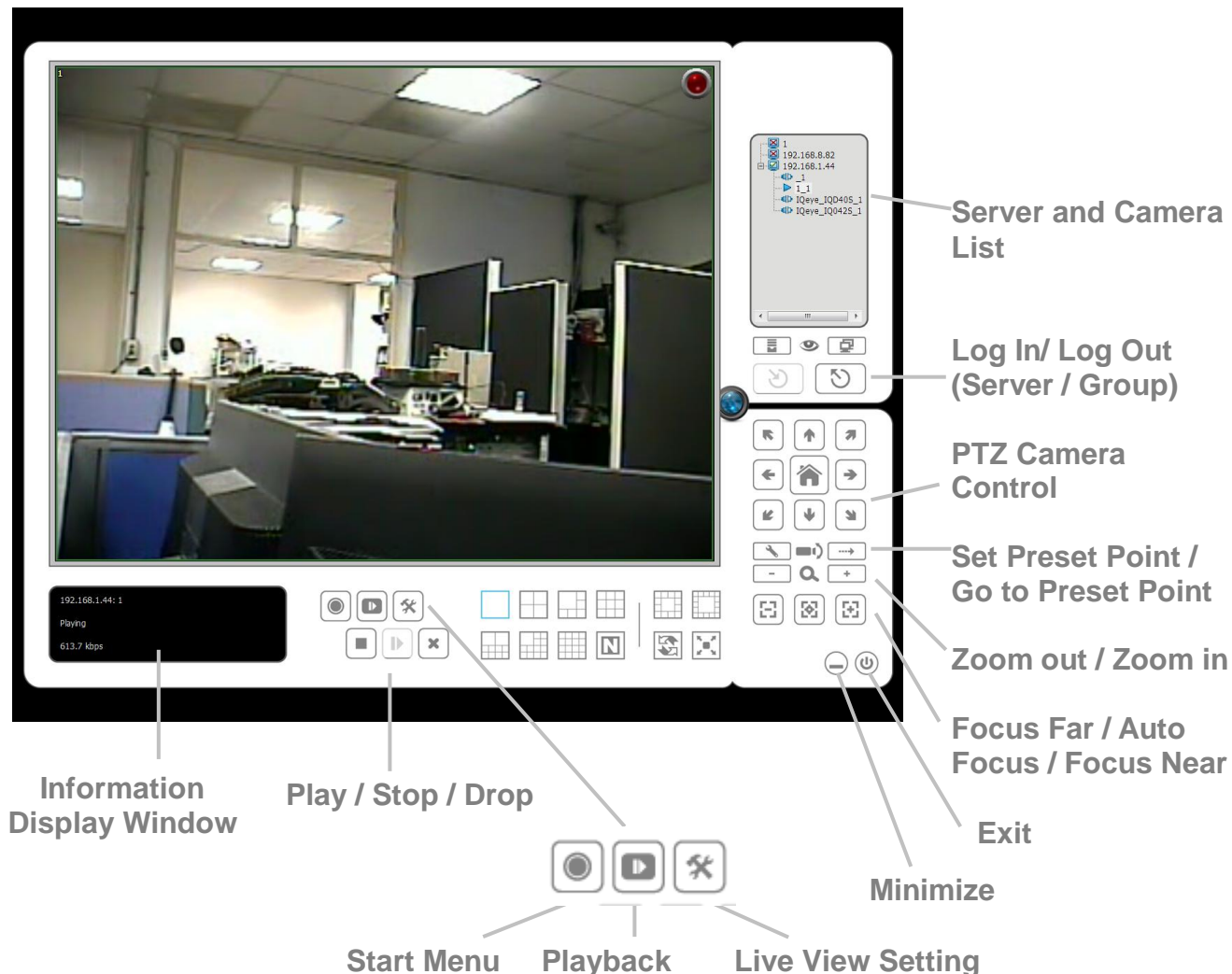
4.2.1 Remote Live Viewer Application Control Panel



- **PTZ Camera Control:** You may control the camera view by using the PTZ camera control panel to adjust the camera's view. This is only available with cameras that support the PTZ function.
- **Set Preset Point / Go to Preset Point:** Adjust the camera view and click the  button to set up this view as preset point. Repeat the process to add more preset points. Click the  button to see the preset view.
- **Zoom:** Click the + or - button to zoom in or zoom out the view.
- **Minimize:** Minimize the Remote Live Viewer window.
- **Exit:** Shut down the application.
- **Play / Stop / Drop:** Select a camera/ video and click this button to play/stop/disconnect a particular channel.
- **Information Display Window:** Display video information including

server name, video current status, and bit rate for a selected channel.

- **Start Monitor > Monitor**: Select Open Monitor to append monitor to view more live videos on multiple monitors.
- **Start Monitor > E-Map**: Upload map and drag camera or I/O on it to track device location and alarm status with instant response when an event occurred. See details in the chapter of **E-Map**.
- **Start Monitor > I/O Control Panel**: Utilize I/O device function remotely. User can remotely adjust the Output Pins by turning it on or off.

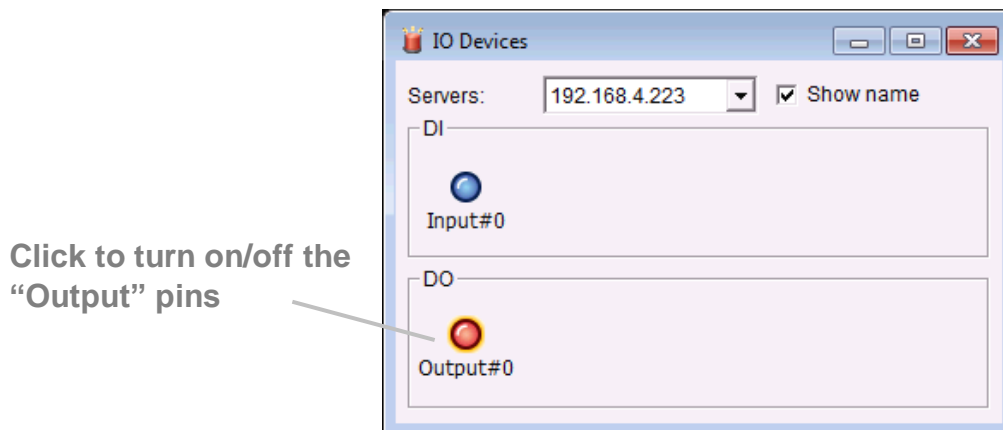

- **Playback**: View playback video remotely.
- **Auto Scan**: Activate auto scan to rotate the channels on the display screen. For instance, you may select to show only 4-split screen on the liveview, while connecting 16 channels to the system. With auto scan function, you are able to see all 16 channels by turns.
- **Layout**: Click to change the multiple-split layout.

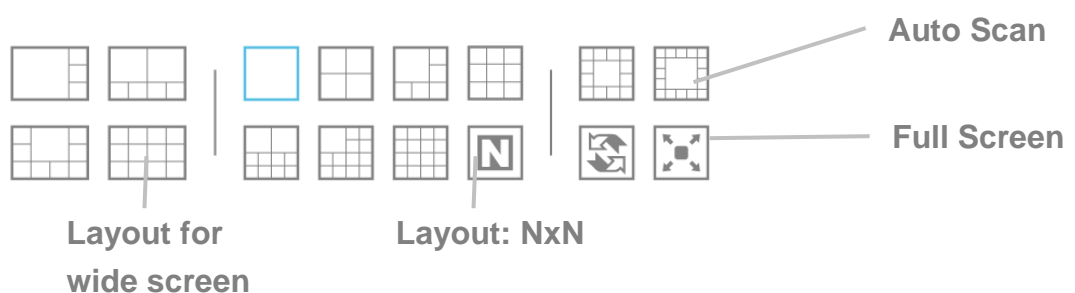

You can right click on the camera screen to enable the following function.

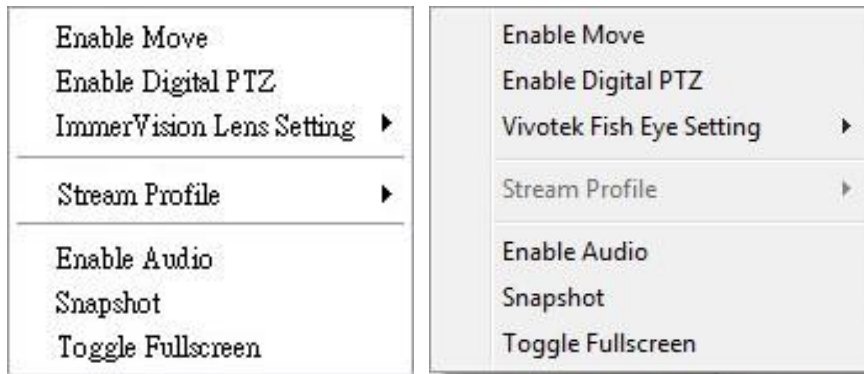

- **Enable Move:** Adjust the current view of camera which supports PT function by dragging the  button on the display screen.
- **Enable Digital PTZ:** Click the + or – button to zoom in or zoom out the view. The lower right square flashing on the video grid indicates the correspondent view of the camera.
- **ImmerVision Lens Setting:** Select the mode of lens, original, PTZ mode, Quad mode and Perimeter mode.
- **Vivotek Fisheye Setting:** Select the mode of lens, Original, Rectilinear mode, Full-view panorama mode, Dual-view panorama mode. Type of modes depends on lens location.
- **Stream Profile:** Select the stream profiles, original, low, minimum.
- **Enable Audio:** Enable audio on active channel(s).
- **Snapshot:** Select the snapshot function to capture a specific video image immediately.
- **Toggle Fullscreen:** Select it to view cameras with full screen. Press “Esc” or right click un-select full screen to go back to the original view.

Also, right click on camera list to duplicate and connect/disconnect designate cameras, and do other functions.



- **Duplicate Camera:** Select the duplicate camera function to create multiple views. The duplicated camera will be shown with green indicator

as the right picture. Combine this function with digital PTZ, users are allowed to enlarge different spots and view them in different channels without failing to record the whole view.

- **Connect / Disconnect:** Click to connect or disconnect the designate camera.
- **Login / Logout Server:** Click to login or logout.
- **Connect All / Disconnect All:** Click to connect or disconnect all cameras.

4.2.2 Unit Connection Setting

1. Startup > NVS > Remote Live Viewer.
2. Click the **General Setting** button.

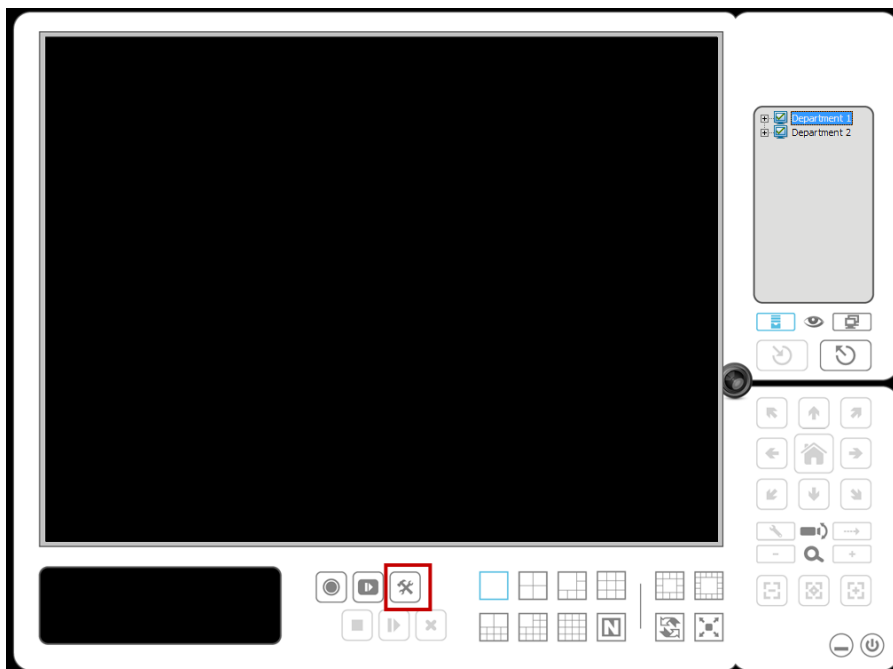

3. Click the **Server** tab.
4. Insert the unit name.

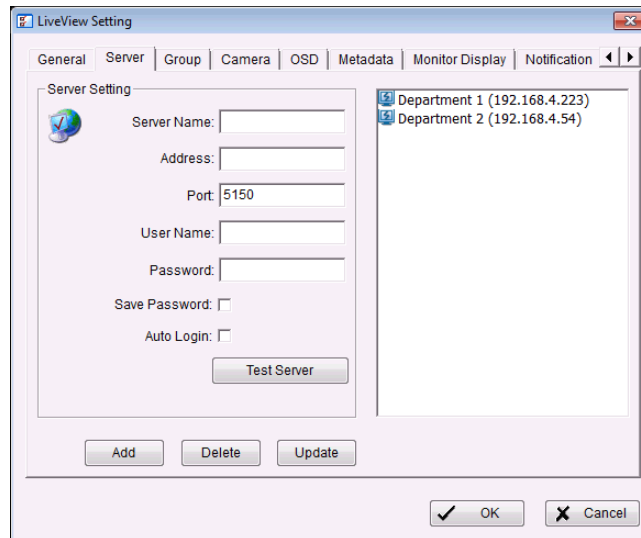

5. Insert the IP address.
6. Modify the port if necessary.
7. Insert the username.
8. Insert the password.
9. Check the **Save Password / Auto login** option.
10. Click the **Test Server** button to test the connection between the local application and the remote unit.
11. Click the **Add** button to add this unit into your remote server list.
12. Click the **OK** button.

4.2.3 General Setting

1. Startup > NVS > Remote Live Viewer.
2. Click the **General Setting** button.

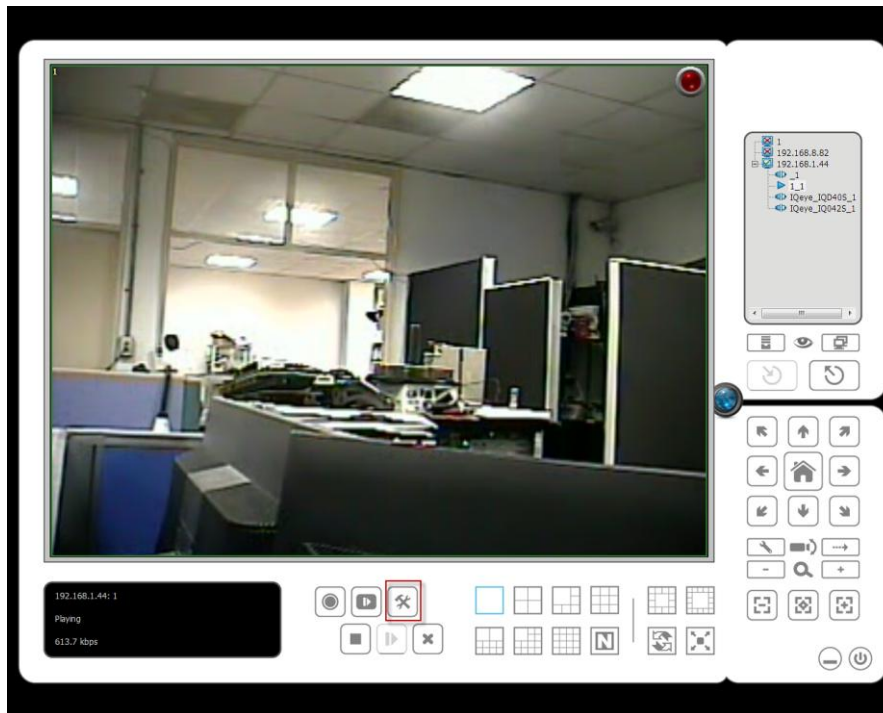

3. Click the **General** tab.

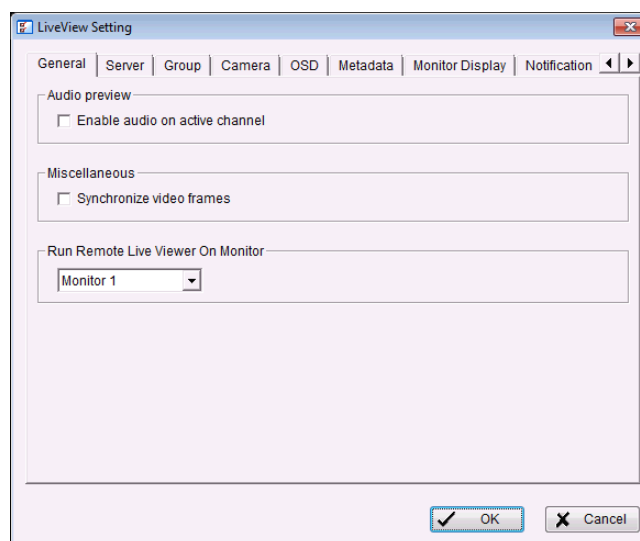

4. Check the **Enable audio on active channel** option to enable audio streaming on active channel. This function synchronizes with right click on camera to enable audio.
5. Check **Synchronize video frames** to avoid the tearing problem occurring in video display while increasing the CPU loading.
6. Select monitor(s) to run LiveView.
7. Click the **OK** button.

4.2.4 Camera Group Setting

You can put different cameras into the same group.

1. Startup > NVS > Remote Live Viewer.
2. Click the **General Setting** button.
3. Click the **Group** tab.

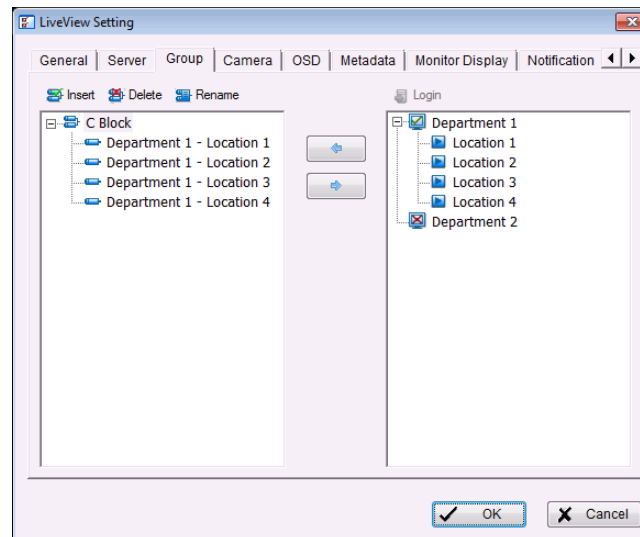

4. Log in to all the servers that contain the camera(s) you would like to put into the group(s).
5. Click the **Insert** button to create a new group.
6. Name this group.
7. Highlight the camera(s) that you would like to add into this group and then click the **<--** button.
8. Repeat step 6 to establish the group.
9. Repeat steps 3 through 7 to establish other groups.
10. Click the **OK** button.

4.2.5 Delete/ Rename Camera Groups

1. Startup > NVS > Remote Live Viewer.
2. Click the **General Setting** button.
3. Click the **Group** tab.
4. Click the group which you want to modify.
5. Click the **Delete** or **Rename** button to remove or rename that group.
6. Repeat steps 3 and 4 to modify other groups.
7. Click the **OK** button.

4.2.6 Stream Profile Setting

Select the preferred stream type of each camera as default live view profile.

1. Startup > NVS > Remote Live Viewer.
2. Click the **General Setting** button.
3. Click the **Camera** tab.

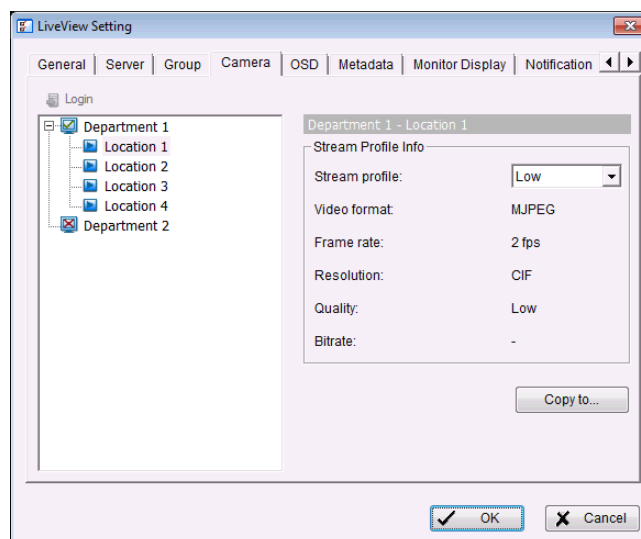

4. Adjust the stream profile of every camera with stream profile enabled in the **setting page**.
5. Click a camera and select its stream profile, and click the **Copy to...** button to apply this profile to other channels.
6. Click the **OK** button.

4.2.7 OSD (On-screen display) Setting

1. Startup > NVS > Remote Live Viewer.
2. Click the **General Setting** button.
3. Click the **OSD** tab.

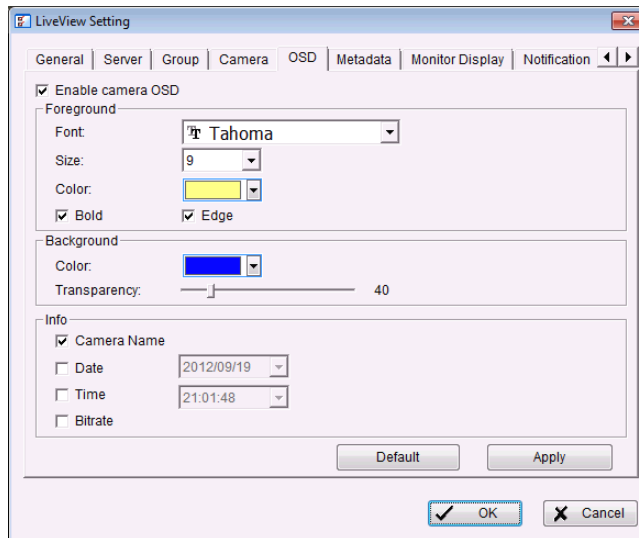

4. Check the **Enable camera OSD** option.
5. Set the foreground and background settings of the OSD.
6. Select which kinds of information will be displayed on the screen.
7. Click the **Apply** button to preview the result.
8. Click the **Default** button to back to the default settings if necessary.
9. Click the **OK** button.

4.2.8 Monitor Display Setting

1. Startup > NVS > Remote Live Viewer.
2. Click the **General Setting** button.
3. Click the **Monitor Display** tab.

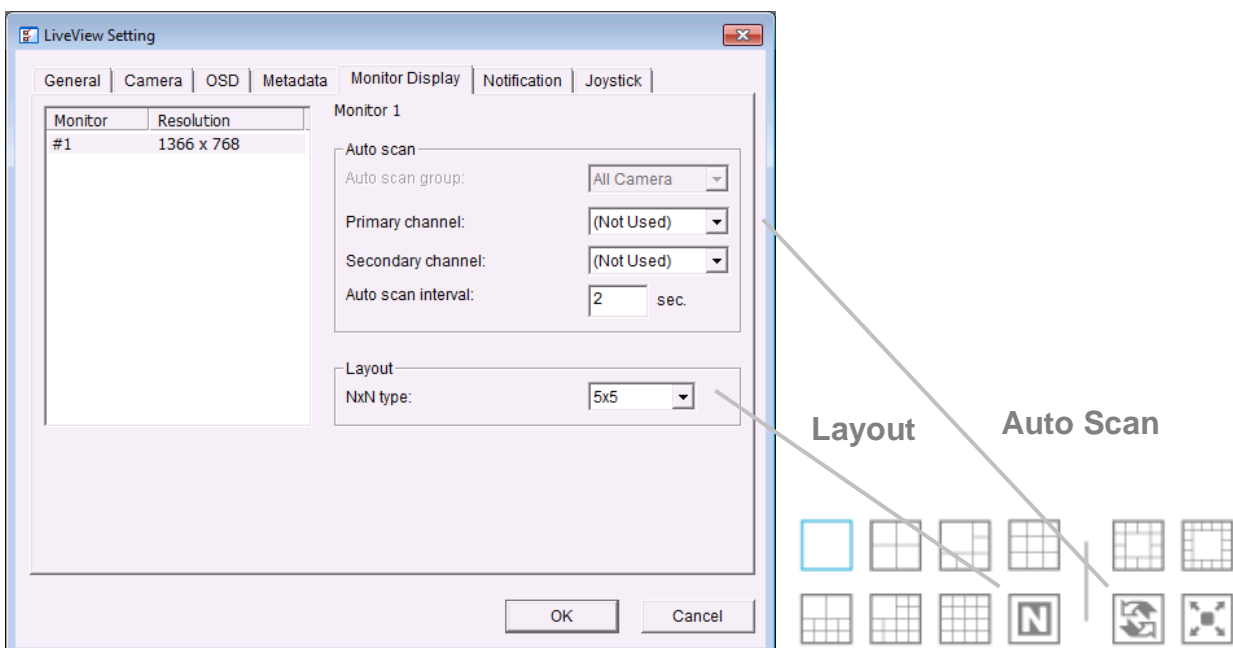

4. Select appointed server group to activate auto scan.
5. Select **Primary channel** which will always be on the screen when activating auto scan; while select **Secondary channel** which has second priority when activating auto scan. Enter the time interval for auto scan.
6. Select the screen division of NxN type.
7. Click the **OK** button.

4.2.9 Notification

1. Startup > NVS > Remote Live Viewer.
2. Click the **General Setting** button.
3. Click the **Notification** tab.

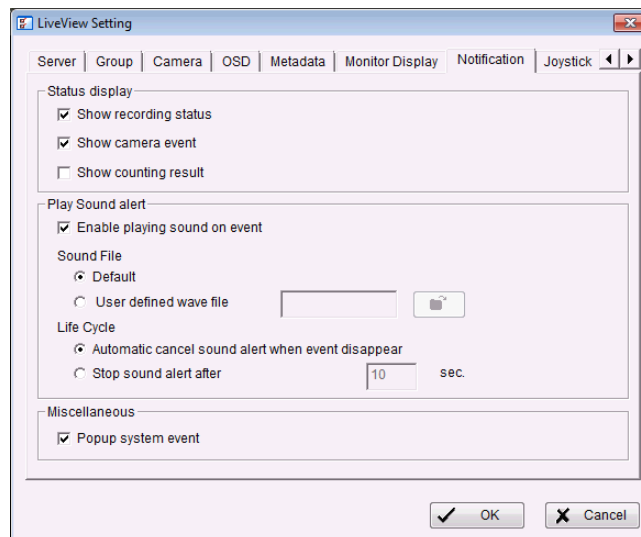

4. Check **Show recording status** to show the crystal ball with recording status on monitor display.
5. Check **Show camera event** to display the words of detected camera event on the correspondent screen.
6. Check the **Enable playing sound on event** option. Select sound file, default sound or user defined sound (.wav), and define the cycle.
7. Check **Popup system event** to pop up system event message dialog as a warning when a system event occurred.
8. Click the **OK** button.



The "playing sound" function only activates on event, which means you have to setup camera motion, camera I/O and I/O Box I/O as an event. Refer to **Event & Action Management** to do the setting.

4.2.10 Set up Joystick Control

1. Startup > NVS > Remote Live Viewer.
2. Click the **General Setting** button.
3. Click the **Joystick** tab.

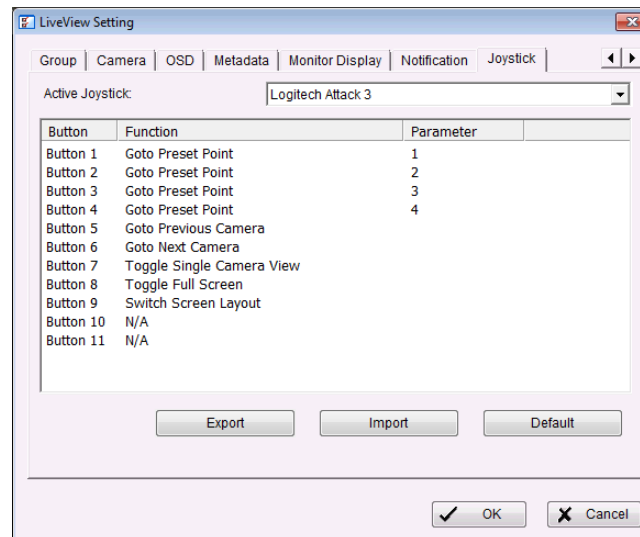

- **Function**: You can choose the function from the drop-down menu for the button of the joystick.

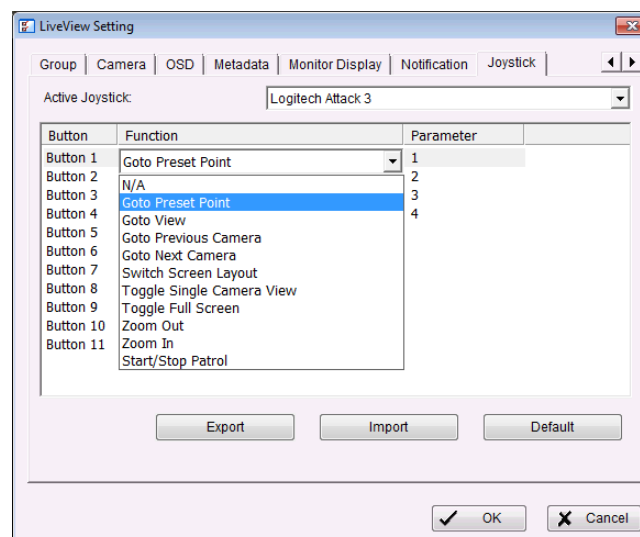

- **Parameter**: Choose the preset point from the drop-down menu.
- **Default**: Click to back to default setting.
- **Import**: Click to import the settings.
- **Export**: Click to export the settings.

4. Click the **OK** button.

4.2.11 Set up Remote Live Viewer



1. Startup > NVS > Remote Live Viewer.
2. Click the unit you wish to access in your remote server list.
3. Click the **LOG IN** button to access your unit.
4. Select a camera(s) from the camera list on the right and then drag it to where you wish the image to be displayed.

5.E-Map

There are two ways to execute the live view function: by Internet Explorer or by **Remote Live Viewer** application.

With E-map, user can easily track the device location and alarm status with instant response when an event occurs. The arrows and lightning icon on E-map represent cameras and I/O devices. These icons will turn red as being triggered by alarms.

There are two modes in E-map application, Edit Mode and Browse Mode.



-  **Edit Mode**: The function buttons on the bottom of this E-map dialog will be active. Users can add/edit/delete maps and indicators of devices.
-  **Browse Mode**: Users are not allowed to do any configuration but check the map hierarchies and device list to see indicators and related information.





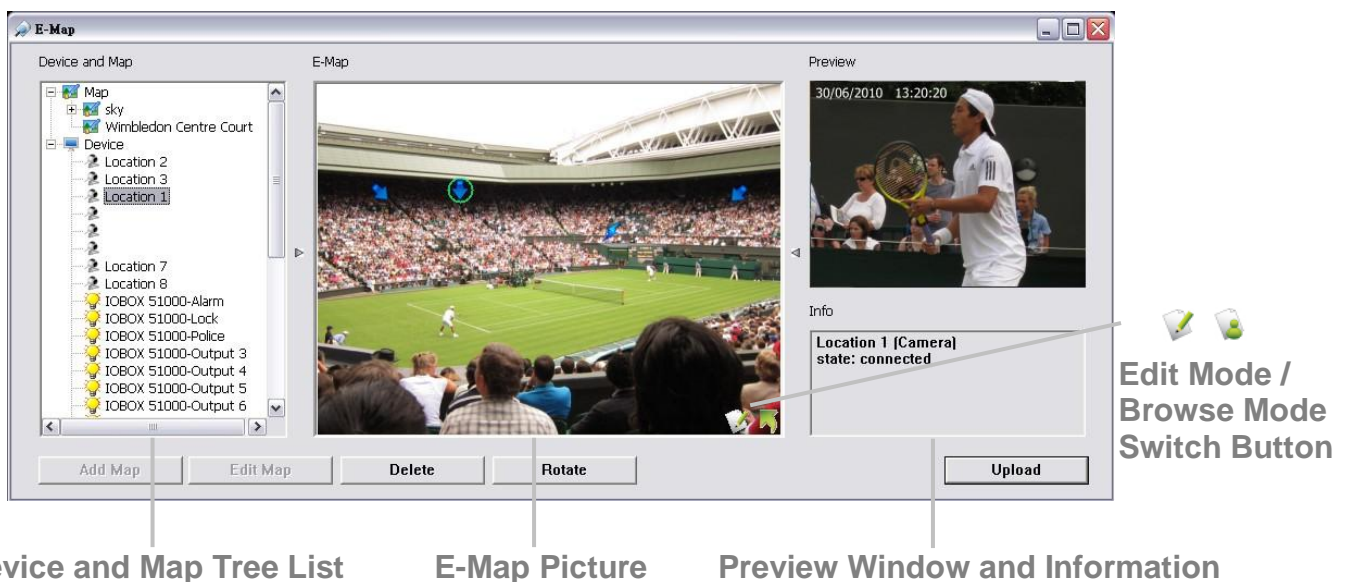

5.1 Internet Explorer

1. Open Internet Explorer and log in to the unit.
2. Click the **Live View** button on the top of the page.
3. Click the **Start Menu** button and select **Open E-Map**.

5.1.1 E-Map Control Panel



-  **Map**: Select a map you want to show on E-map Window.
-  **Camera**: Select the camera to see preview video or mark indicator on

- E-map.
-  **Digital Input**: Select it to highlight the device with green ring on map and show status on Information Window. If the Digital Input is from IP camera, the preview window will display live video of the camera.
-  **Digital Output**: Select it to highlight the device with green ring on map and show status on Information Window. If the Digital Output is from IP camera, the preview window will display live video of the camera.
-  **Map Indicator**: Clicking the indicator will lead to the next map layer. If you want to move to the upper layer, select it by mouse directly or click  icon on the map.
-  **Camera Indicator**: The indicator of cameras dragged from Device and Map Tree List to show preview video and related information. When event occurs, the color of indicator will turn red.
-  **Digital I/O Indicator**: The indicator of I/O devices dragged from Device and Map Tree List to show related information. When event occurs, the color of indicator will turn red.
- **Information Window**: The window shows the related information of each indicator.
 - **Map**: Show map name.
 - **Camera**: Show camera name and connecting status.
 - **Digital Input**: Show Digital Input name and status (0 or 1).
 - **Digital Output**: Show Digital Output name and status (0 or 1).

5.1.2 Add Map

1. Make sure being in "Edit Mode" and all devices are inserted and connected.
2. Right click on the Map icon  in Device and Map Tree List to obtain the option menu to add map, or just click the **Add Map** button to configure.



3. Select a map file and insert a name. Click the **OK** button, and then the map you added appears in the Device and Map Tree List.
4. The map indicator  appears on the upper left of map. Drag it to the position you want on appointed map.

5. Repeat steps 2 through 4 to add more maps.
6. Click the **Upload** button to activate all the settings.



The maximum file size of each map is 500KB. There are 10 layers of map, and the map capacity of each layer is 10.

5.1.3 Edit Map

1. Make sure being in "Edit Mode" and all devices are inserted and connected.
2. Right click on the Map icon 🗺️ in Device and Map Tree List to obtain the option menu to edit map, or just click the **Edit Map** button to configure.
3. Repeat step 2 to edit more maps.
4. Click the **Upload** button to activate all the settings.

5.1.4 Delete Map

1. Make sure being in "Edit Mode" and all devices are inserted and connected.
2. Right click on the Map icon 🗺️ in Device and Map Tree List to obtain the option menu to delete map, or just click the **Delete** button.
3. Repeat step 2 to delete more map.
4. Click the **Upload** button to activate all the settings.

5.1.5 Add/Rotate Device Indicator

1. Make sure being in "Edit Mode" and all devices are inserted and connected.
2. Select the map which you want to add device indicator on.
3. Select a device from list and directly drag it to the desired location on the map.
4. Select a camera indicator and right click on the indicator or click the **Rotate** button to adjust the direction of camera indicator if needed.
5. Repeat steps 2 and 4 to add more indicators on.
6. Click the **Upload** button to activate all the settings.

5.1.6 Delete Device Indicator

1. Make sure being in "Edit Mode" and all devices are inserted and connected.
2. Select the indicator and right click on the indicator or click the **Delete** button.
3. Repeat step 2 to delete more indicators.
4. Click the **Upload** button to activate all the settings.

5.1.7 Layout Adjustment

Adjust the Layout



- ▶ ◀ **Adjust the Layout:** Click the triangular indicator to hide the Device and Map Tree List / Preview and Information Window on right and left side of the window. Click the indicator again to back to the default.
- ◻ **Maximize the Map:** Click the icon on the upper right to get the full screen display of E-map.

5.1.8 Relative Configuration and Application

When an event occurs, related E-map pops up to indicate the location of this event. Please check the **Notification** function for details.

5.2 Remote Live Viewer Application

1. Startup > NVS > Remote Live Viewer.
2. Click the **Start Monitor** button and select Open E-Map.

5.2.1 E-Map Control Panel



Device and Map Tree List

E-Map Picture

Preview Window and Information

- **Server List:** Select a server to display the E-map of the server.



The E-Map function of Remote Live Viewer is quite similar with the one in Internet Explorer, so you can refer to the section of **Internet Explorer** for the details.

6. Playback

There are two ways to execute the playback function: with Internet Explorer or with the **Playback System** application.

6.1 Internet Explorer

6.1.1 Playback Control Panel

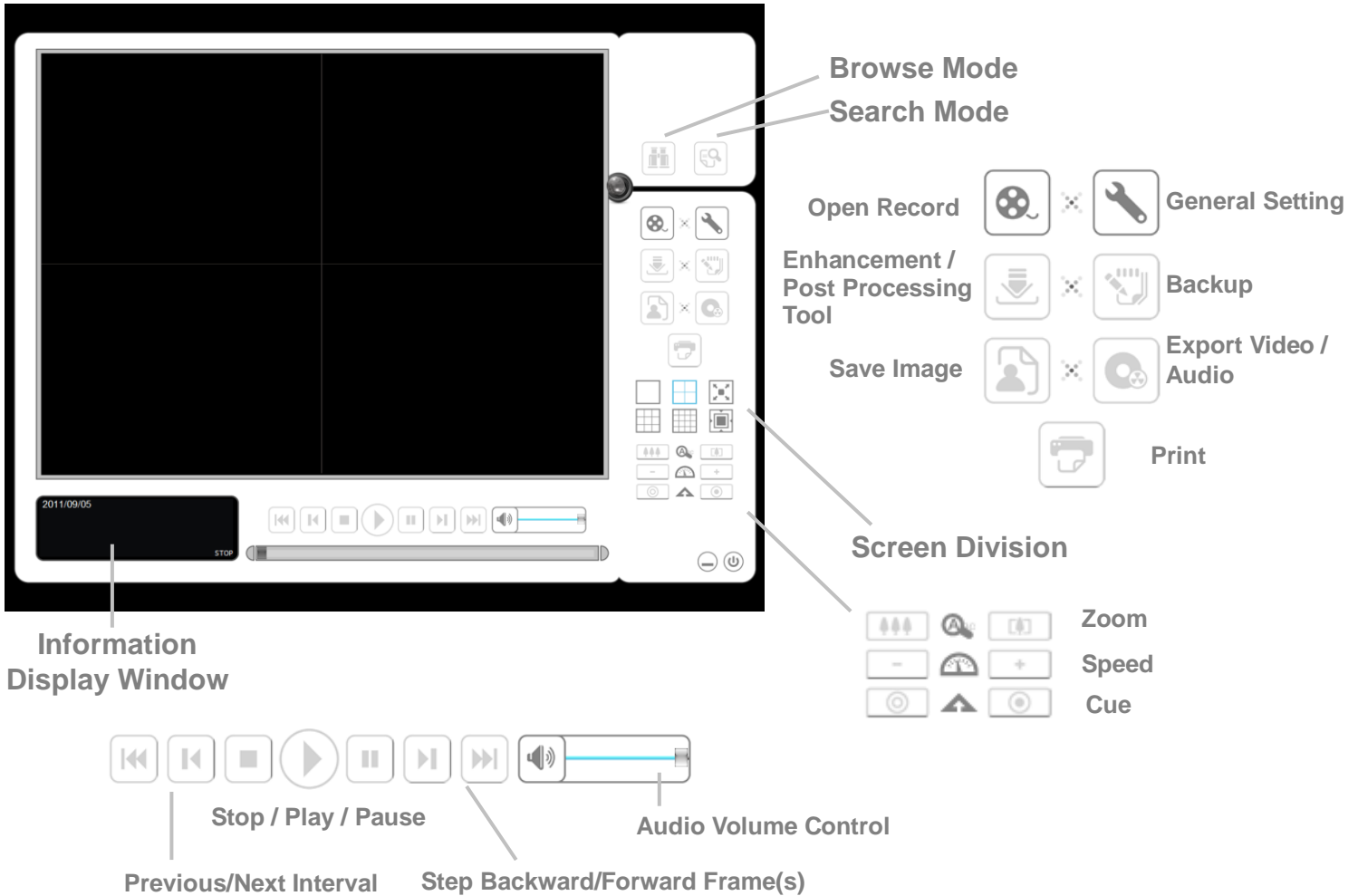

- **Information Display Window:** Displays video date and time, cue-in / cue-out point times, and speed.
- **Audio Volume Control:** Adjust the sound level.
- **Screen Division:** Allocate the sub-screen display by clicking on the desired layout icon. To switch to single camera display, double click a particular sub-screen. Double click the screen again to regain previous screen division layout.
- **Browse Mode:** Play the recorded video when in Search Mode.

- **Open Record**: Click the **Open Record** button to access the Date-Time Panel and select the video records which you want to review.
- **General Setting**
 - **Record Display**
 - Calendar View: view the Record Display Window as a calendar.
 - List Control: view the Record Display Window as a list control.
 - **Play**
 - Play when open: check this option to set the system to start playing the video clip every time a record is withdrawn.
 - Auto-skip when recording in motion-only mode: check this option to set up the system to automatically skip to the points where there were motions recorded.
 - Next interval: set the interval with which the video goes forward when you click the **Next** button on the control panel.
 - Previous interval: set the interval with which the video goes backward when you click the **Previous** button on the control panel.
 - **Capture Image**
 - Save in clipboard: the image will be saved in the clipboard and can be pasted to other application software.
 - Manually save the image file: you can manually select where you want to save the image, name the saved file, and choose the format you want to save the image.
 - Automatically save the image file: by presetting a path/URL and the image format, the system will automatically save the image accordingly when you click the **Save Image** button on the control panel.

You can right click on the camera screen to enable the following function.



- **Toggle Fullscreen**: Select it to view cameras with full screen. Press "Esc" or right click un-select full screen to go back to the original view.
- **Enable ImmerVision PTZ**: Adjust PTZ in PTZ mode.
- **ImmerVision Lens Setting**: Select the mode of lens, original, PTZ mode, Quad mode and Perimeter mode.
- **Enable Vivotek Fish Eye PTZ**: Adjust PTZ in PTZ mode.
- **Vivotek Fish Eye Setting**: Select the mode of lens, Original, Rectilinear

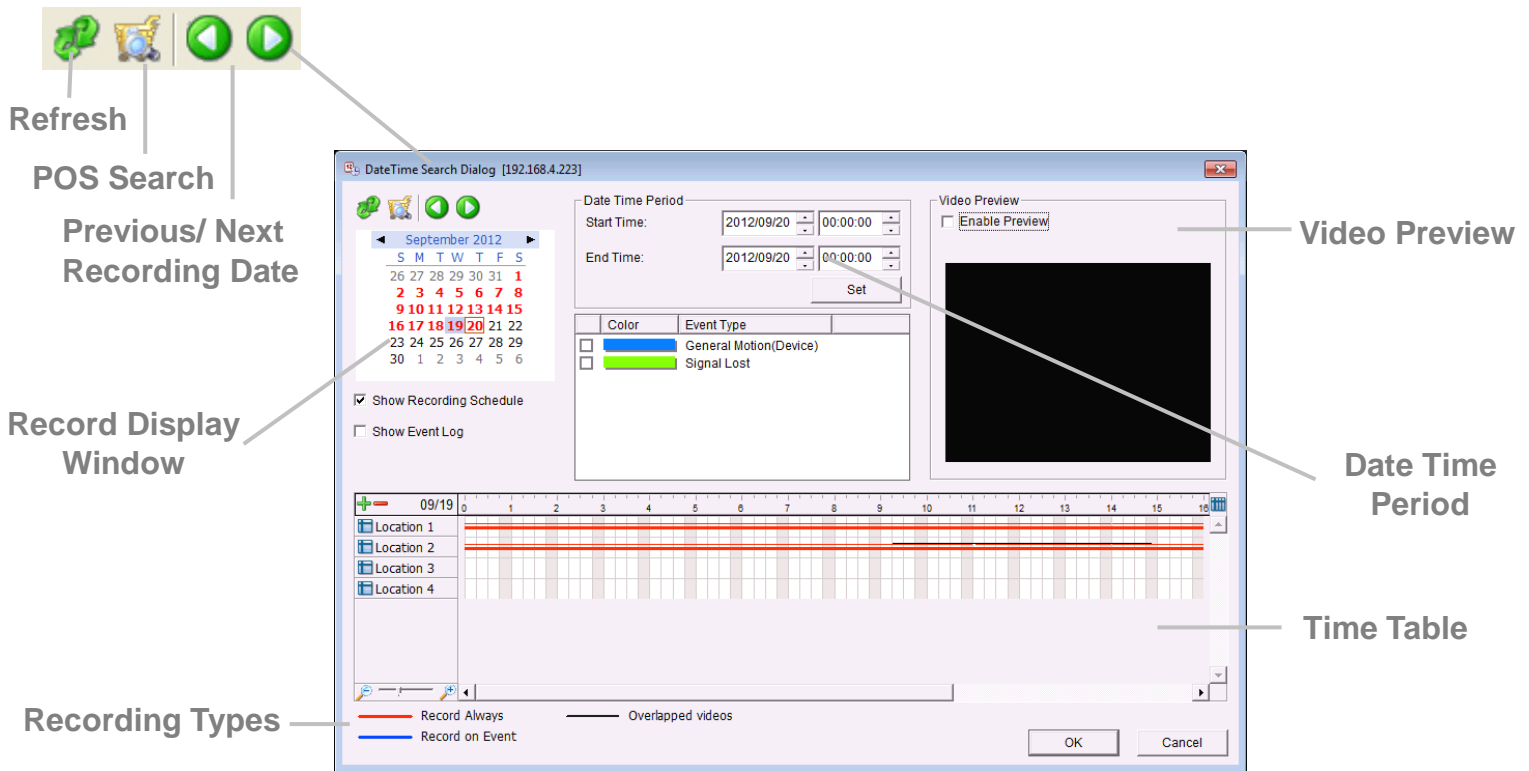

mode, Full-view panorama mode, Dual-view panorama mode. Type of modes depends on lens location.

6.1.2 Search the Recorded Video





- : refresh the Record Display Window.
 - or : go to previous or next recording date.
 - **Record Display Window**: Display the available recorded video records.
 - **Date Time Period**: Select the start and end time points that indicate the time period you would like to view after choosing cameras.
 - **Video Preview**: Check the **Enable Preview** option to view the selected video.
 - **Time Table** (preset recording schedule): Click the icon to select all channels; click the icon to deselect all channels. Finally, use the scale bar to modify the scale of the time table.
 - **Recording Types**: Red line in bold represents always record. Blue line in bold represents record on event. Red thin line represents recording data. Black thin line represents that there are multiple video clips within the same period due to system time change (e.g. daylight saving time)
- Record Always Record on Event Overlapped videos
- **Show Recording Schedule**: Show the period of recording schedule in the time table.

- **Show Event Log**: Show the time of event detection in the time table. Color of event type can be defined by preference.

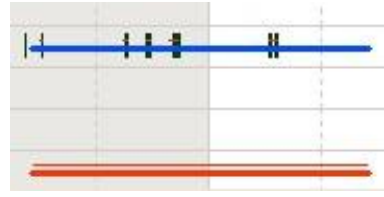
Color	Event Type
<input type="checkbox"/> 	General Motion(Device)
<input type="checkbox"/> 	Signal Lost

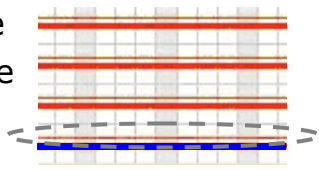

1. From the Record Display Window at the top left of the Date Time Panel, select the date you want to search the record from. The red lines shown on the time table indicate available recorded video records. 
2. Use color bars to differentiate recording types from each other. This will help you select video clips.
3. Highlight the video clip you want to review by left-clicking and dragging the time period. You may also utilize the Start Time and End Time in Date Time Period Section after choosing camera. In addition, modify the scale of the time table with the  or  icon on the bottom left.
4. If there are multiple videos of the time period you select, the following dialog may popup to guide you to select one to play.

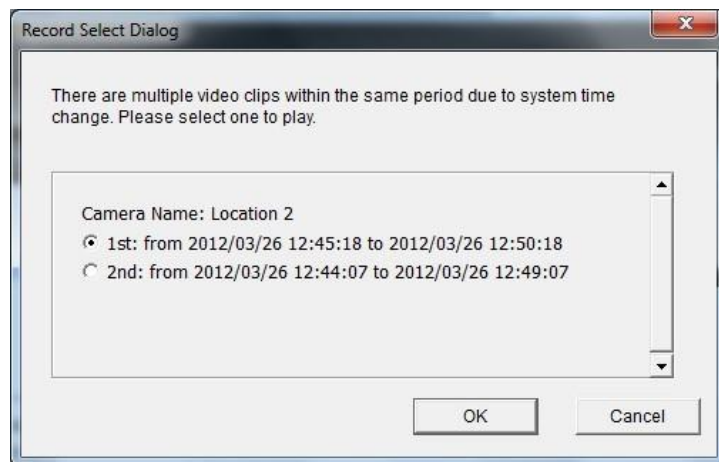

5. Check the **Enable Preview** option to get the preview of the video you select.
6. Click the camera name to increase or decrease cameras you want to playback.
7. Click the **OK** button.



The Record Display Window can be shown in (a) calendar view or (b) list control view. To modify the settings of the record display window, click the **General Setting** button at the right of the page.

6.1.3 Play the Recorded Video

1. Be sure that you have set the schedule / recording event first.
2. Open Internet Explorer and log in to the unit.
3. Click the **Playback** button on the top of the page.
4. Click the **Open Record** button.
5. The Record Display Window will show the information of the available video clips. Select the date you want to search the record from.
6. Highlight the video records that you want to review.
7. Click the **OK** button.

6.1.4 Intelligent Search

After opening the recorded video, click the **Search Mode** button to obtain the Intelligent Search Tool panel. You can search for unusual events during the recording period.

There are 5 types of unusual events: **General Motion**, **Foreign Object**, **Missing Object**, **Focus Lost**, and **Camera Occlusion**.

- **General Motion**: Detect all movements in the defined area.

1. Define detection zone by dragging to draw a detection zone. You may define more than one zone by repeating this step.
2. Modify the sensitivity setting by changing the slider control. Moving toward the right will increase the sensitivity level, which means a relatively small movement will trigger the alarm.
3. Set the interval. Moving toward right will increase time interval so that the alarm will only be triggered when the movement lasts longer.
4. Check the **Stop when found** option. If unchecked, the search tool will list all the events it found, instead of stopping at the moment the event found.
5. Click the **Search** button.

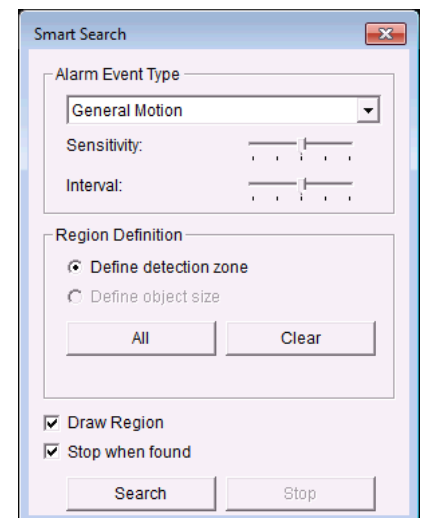

- **Foreign Object**: Alarm is set on when any additional object appears in the defined area on the screen.

1. Define detection zone by dragging to draw a detection zone.
2. Modify the sensitivity setting.
3. Set the Interval.
4. Check the **Stop when found** option. If unchecked, the search tool will list all the events it found, instead of stopping at the moment the event found.
5. Click the **Search** button.

- **Missing Object:** Alarm is set on when the selected object is removed from the defined area on the screen.

1. Define detection object by dragging to draw a detection zone.
2. Modify the sensitivity setting.
3. Set the Interval.
4. Check the **Stop when found** option. If unchecked, the search tool will list all the events it found, instead of stopping at the moment the event found.
5. Click the **Search** button.

- **Focus Lost:** System will inform you when the camera(s) lose its focus.
- **Camera Occlusion:** Alarms when the camera is blocked.

6.1.5 Recorded Video Enhancement

1. Open Internet Explorer and log in to the unit.
2. Click the **Playback** button on the top of the page.
3. Click the **Open Record** button.
4. The Record Display Window will show the information of the available video clips. Select the date you want to search the record from.
5. Highlight the video clip you want to review, and then click the **OK** button.
6. Click the **Enhancement** button.
7. Check the General Setting.

- **Apply active channel:** The settings will only be applied to the selected channel.
- **Apply all channels:** The settings will be applied to those currently shown on the screen.

8. Set the Filter Setting.

- **Visibility:** Check the option and adjust the gamma value of the image to enhance the image and make

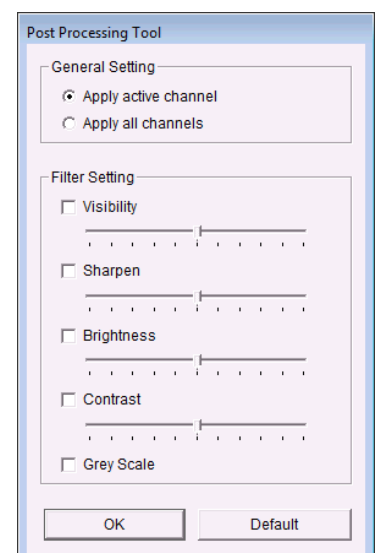

it cleaner.

- **Sharpen**: Check the option to activate the function. Move the slider control to the right to sharpen the image, to the left to soften it.
- **Brightness**: Check the option to activate the function. Move the slider control to the right to make the image brighter.
- **Contrast**: Check the option to activate the function. Move the slider control to the right to increase contrast.
- **Grey Scale**: Check the option to show the record in gray-scale mode so the image displays in black and white.

9. Click the **OK** button.

- **Stop**: Stop the enhancement function and close the enhancement tool. (The system will automatically back to the default settings.)
- **Default**: Back to the default settings, however, the enhancement tool still works.
- **OK**: Apply the modifications of the settings.

6.1.6 Save a Video

1. Open Internet Explorer and log in to the unit.
2. Click the **Playback** button on the top of the page.
3. Click the **Open Record** button.
4. The Record Display Window will show the information of the available video clips. Select the date you want to search the record from.
5. Highlight the video clip you want to review, and then click the **OK** button.
6. Choose the camera display that you want to save as a video clip.
7. Set up the cue in and cue out points; the cue in and cue out time will be shown on the information window.

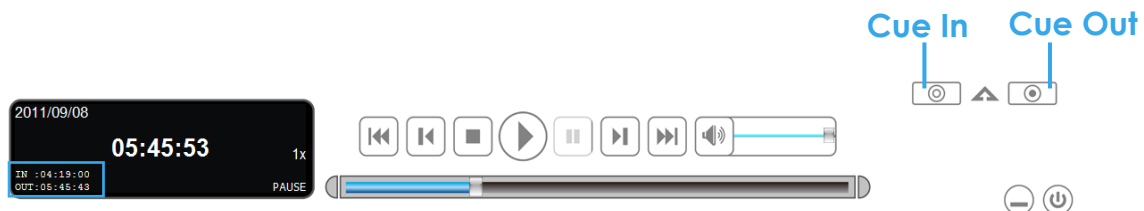

8. Click the **Save Video** button.

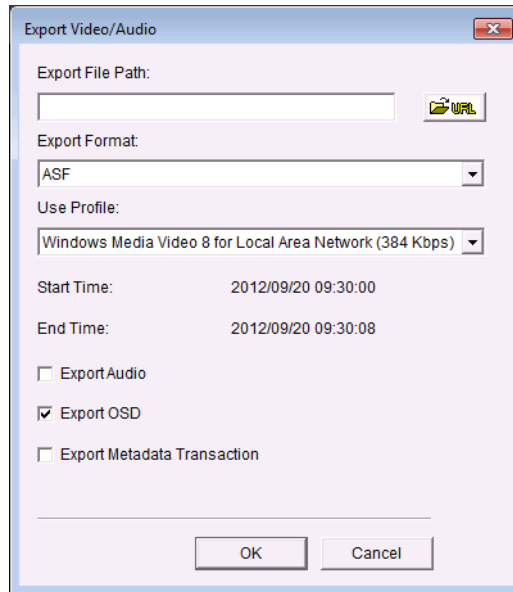

9. Choose the folder where you want to save the file.
10. Insert the file name and click the **Save** button.
11. Choose the export format.
12. Choose the use profile.
13. Check to export the recorded video with Audio, OSD and POS Transaction.
14. Click the **OK** button.



We recommend that you export to the .asf format when saving video. In exporting to the .avi format, the frame rate will be increased when playing in the video player, causing the video to run faster than normal.

6.1.7 Save an Image

1. Open Internet Explorer and log in to the unit.
2. Click the **Playback** button on the top of the page.
3. Click the **Open Record** button.
4. The Record Display Window will show the information of the available video clips. Select the date you want to search the record from.
5. Highlight the video clip you want to review, and then click the **OK** button.
6. Choose the camera display that you want to save pictures.
7. Click the **Save Image** button when the image you want is shown on the screen.
8. Choose the folder where you want to save the file at.
9. Choose the folder and the image format (BMP or JPEG) you prefer.
10. Insert the file name.
11. Click the **Save** button.



You may skip step 3 by presetting the folder where you want to save the images and the format you want to save them in.

6.1.8 Print an Image

Print the current image of the video you choose.

1. Open Internet Explorer and log in to the unit.
2. Click the **Playback** button on the top of the page.
3. Click the **Open Record** button.
4. The Record Display Window will show the information of the available video clips. Select the date you want to search the record from.
5. Highlight the video clip you want to review, and then click the **OK** button.
6. Choose the camera display from which you want to print pictures.
7. Click the **Print** button when the image you want is shown on the screen.
8. Set print settings.

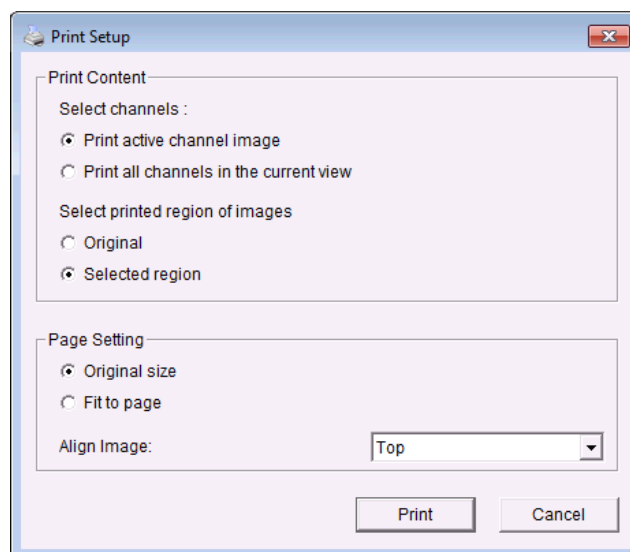

- **Print Content:** Print the image from currently selected channel or all the channels shown on the screen.
 - **Page Setting**
 - **Print in original size:** Check to have the image print in original size.
 - **Fit the page:** Check to have the image fit the page.
 - **Align Image:** Top, center, or bottom
9. Click the **Print** button.

6.1.9 Backup the Recorded Video

Different from Save Video, the Backup function will save all the recorded videos which belong to the time slot you set, instead of the clips.

1. Open Internet Explorer and log in to the unit.
2. Click the **Open Record** button to select data.
3. Click the **Backup** button.

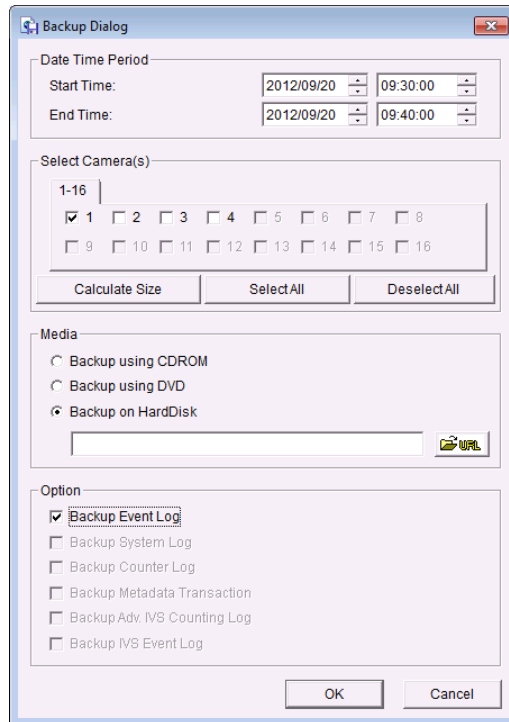

4. Set the Start Time and End Time you want to backup.
5. Select the cameras you want to backup.
6. Select the directory you want to save the backup data.
7. Click the **Backup** button.
8. The system will then begin backup process automatically.

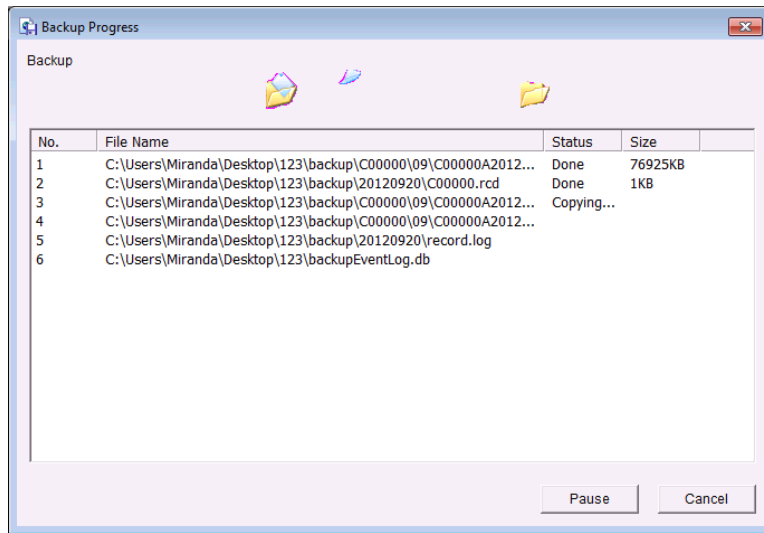

6.2 Remote Playback System Application

6.2.1 Playback System Application Control Panel

The **Playback System** control panel is similar to the playback panel in Internet Explorer. Check **Playback Control Panel** for more details about those buttons.

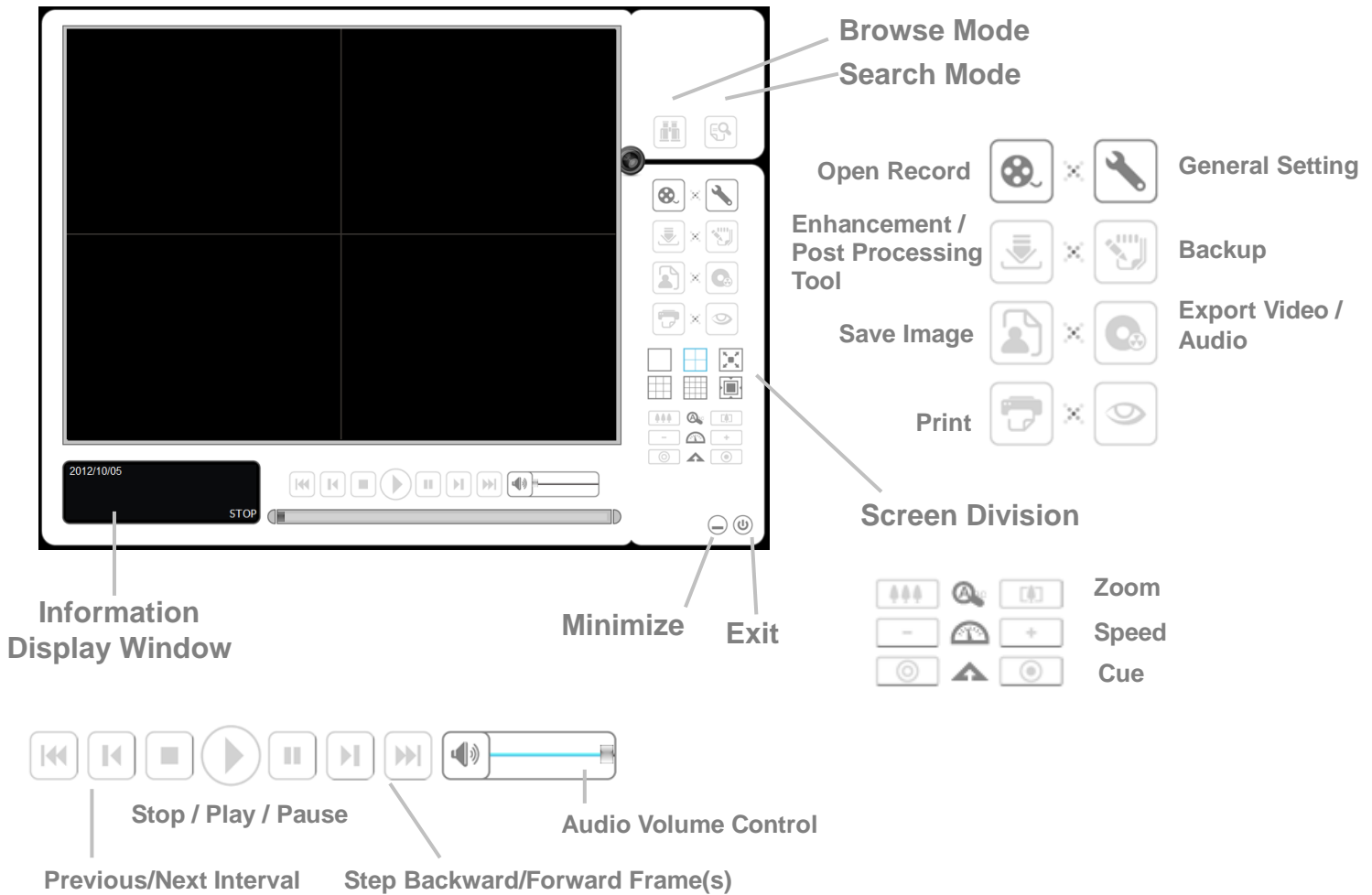

6.2.2 Set up Unit Connections

Before using the **Playback System** application, you need to set a connection to your unit first.

1. Startup > NVS > Playback System.
2. Click the **General Setting** button.
3. Click the **Server** tab.

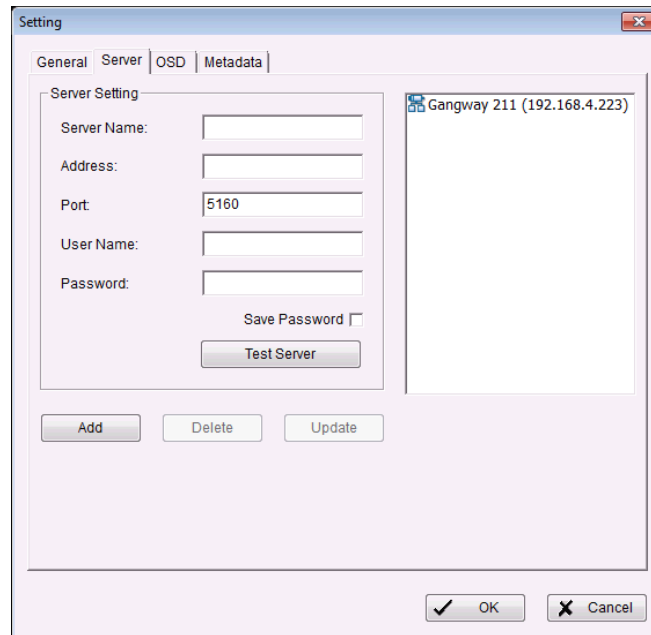

4. Insert the name of your unit.
5. Insert the IP address of that unit.
6. Modify the port if necessary.
7. Insert the username.
8. Insert the password.
9. Check the **Save Password** option.
10. Click the **Test Server** button to test the connection between the local application and the remote unit.
11. Click the **Add** button to add this unit into the remote server list.
12. Click the **OK** button.

6.2.3 Search the Recorded Video

Remote Playback
Site Management

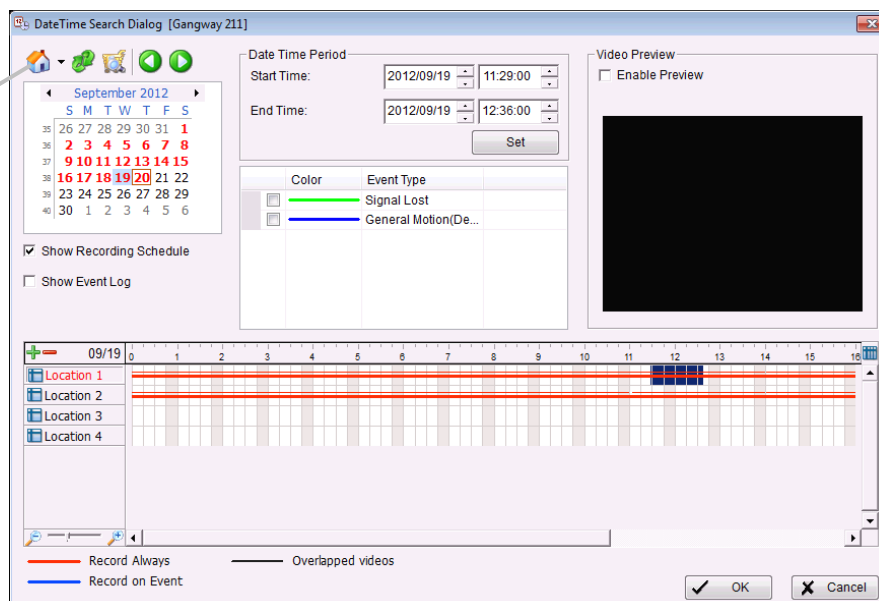

1. Startup > NVS > Playback System.
2. Click the **Open Record** button.
3. Click the  icon on the top of the Date-Time Panel to obtain the Remote Playback Site Management dialog, and then select the server you want to access.
4. Highlight the records you want to view in the Time Table.
5. Set the Date Time Period.

The search process in the **Playback System** application is similar to that of Internet Explorer. Check **Search the Recorded Video** for more details about the setting process.

6.2.4 Play the Recorded Video

1. Be sure that you have set up the recording schedule / response first.
2. Startup > NVS > Playback System.
3. Click the **General Setting** button and the **Server** tab to set connections to your unit. See **Set up Unit Connections** for more details.
4. Click the **Open Record** button.
5. The Record Display Window will show the information of the available video clips. Select the date you want to search the record from. Check **Search the Recorded Video** for more details.
6. Highlight the video records that you want to review.
7. Select the start and end points in Date Time Period to adjust the time slot.
8. Click the **OK** button.

6.2.5 Intelligent Search

1. Startup > NVS > Playback System.
2. Click the **Open Record** button.
3. The Record Display Window will show the information of the available video clips. Select the date you want to search the record from. Check **Search the Recorded Video** for more details.
4. Highlight the video records that you want to review.
5. Choose the camera display for which you want to implement smart search.
6. Click the **Search Mode** button to open the Intelligent Search Tool panel.
7. Set up unusual events here to detect abnormalities occurring during the recording period. Check **Intelligent Search** for more details.

8. The searched events will be listed. Click to find that event.

There are 5 types of unusual events: **General Motion**, **Foreign Object**, **Missing Object**, **Focus Lost**, and **Camera Occlusion**.

- **General Motion**: Detect all movements in the defined area.
- **Foreign Object**: Alarm when any additional object appears in the defined area on the screen.
- **Missing Object**: Alarm when the selected object is removed from the defined area on the screen.
- **Focus Lost**: System will inform you when the camera(s) lose focus.
- **Camera Occlusion**: Alarm when the camera is blocked.

The intelligent search in the **Playback System** application is similar to that of Internet Explorer.

6.2.6 Recorded Video Enhancement

1. Startup > NVS > Playback System.
2. Click the **Open Record** button.
3. The Record Display Window will show the information of the available video clips. Select the date you want to search the record from. Check **Search the Recorded Video** for more details.
4. Highlight the video records that you want to review.
5. Choose the camera display that you want to implement video enhancement.
6. Click the **Enhancement** button.
7. Check the General Setting.
 - **Apply active channel**: The settings will only be applied to the selected channel.
 - **Apply all channels**: The settings will be applied to those currently shown on the screen.
8. Set the Filter Setting.
 - **Visibility**: Check the option and adjust the gamma value of the image to enhance the image and make it cleaner.
 - **Sharpen**: Check the option to activate the function. Move the slider control to the right to sharpen the image, to the left to soften it.

- **Brightness:** Check the option to activate the function. Move the slider control to the right to make the image brighter.
- **Contrast:** Check the option to activate the function. Move the slider control to the right to increase contrast.
- **Grey Scale:** Check the option to show the record in gray-scale mode so the image displays in black and white.

9. Click the **OK** button.

- **Stop:** Stop the enhancement function and close the enhancement tool. (The system will automatically revert back to the default settings.)
- **Default:** Back to the default settings, however, the enhancement tool still works.
- **OK:** Apply the modifications of the settings.

6.2.7 Save a Video

1. Startup > NVS > Playback System.
2. Click the **Open Record** button.
3. The Record Display Window will show the information of the available video clips. Select the date from which you want to search the record. Check **Search the Recorded Video** for more details.
4. Highlight the video records that you want to review.
5. Choose the camera display that you want to save as a video clip.
6. Set up the cue in and cue out points; the cue in and cue out time will show on the information window.

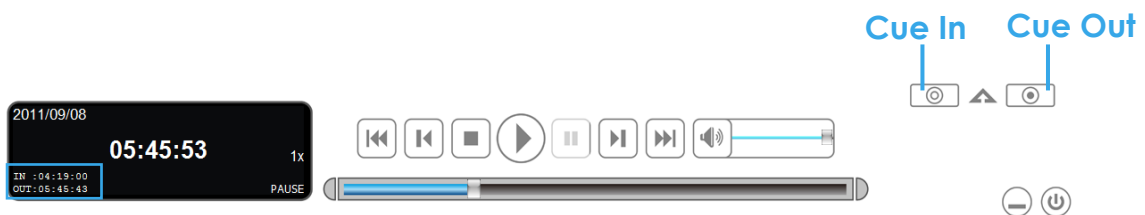

7. Click the **Save Video** button.
8. Choose the folder where you want to save the file.
9. Insert the file name and click the **Save** button.
10. Choose the export format.
11. Choose the use profile.
12. Check the **Export Audio** option.
13. Click the **OK** button.

6.2.8 Save an Image

1. Startup > NVS > Playback System.
2. Click the **Open Record** button.
3. The Record Display Window will show the information of the available video clips. Select the date from which you want to search the record. Check **Search the Recorded Video** for more details.
4. Highlight the video records that you want to review.
5. Choose the camera display from which you want to save pictures.
6. Click the **Save Image** button when the image you want is shown on the screen.
7. Choose the folder where you want to save the file at.
8. Choose the format of image (BMP or JPEG) you prefer.
9. Insert the file name.
10. Click the **Save** button.



You may skip step 7 by presetting a folder where you want to save the images and a format which you want to save the images in.

6.2.9 Print an Image

Print the current image of the video you choose.

1. Startup > NVS > Playback System.
 2. Click the **Open Record** button.
 3. The Record Display Window will show the information of the available video clips. Select the date you want to search the record from. Check **Search the Recorded Video** for more details.
 4. Highlight the video records that you want to review.
 5. Choose the camera display that you want to print pictures.
 6. Click the **Print** button.
 7. Set the print settings.
- **Print Content:** Print the image from currently selected channel or all the channels shown on the screen.
 - **Page Setting**
 - **Print in original size:** Select to have the image print in original size.
 - **Fit the page:** Select to have the image fit the page.
 - **Align Image:** Top, center, or bottom

6.2.10 Backup the Recorded Video

Different from Save Video, the Backup function will save all the recorded videos which belong to the time slot you set, instead of the clips.

1. Startup > NVS > Playback System.
2. Click the **Open Record** button to select data.
3. Click the **Backup** button.
4. Set the Start Time and End Time you want to backup.
5. Select the cameras you want to backup.
6. Select the directory you want to save the backup data.
7. Click the **Backup** button.

7.Backup and Delete Records

7.1 The Backup System Application

In addition to the ways mentioned in the previous chapters, you can apply the application to backup your files.

1. Startup > NVS > Backup System.

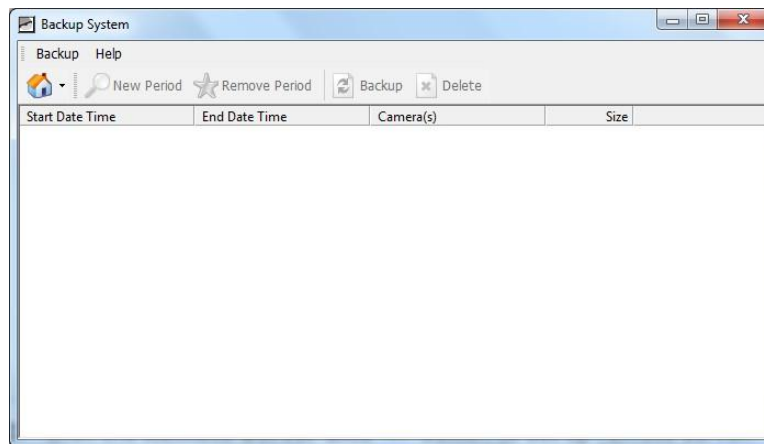

2. Click the **Remote Server Site**  button to set up remote server.

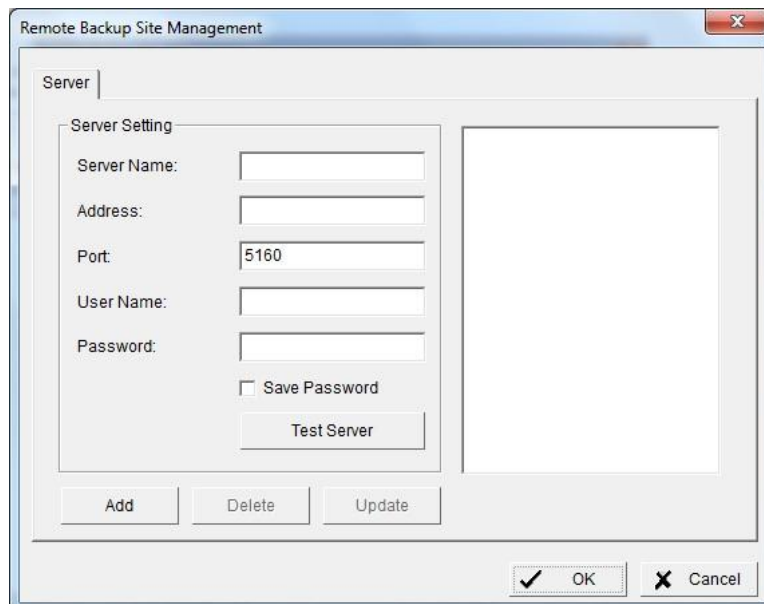

3. Insert the name of your unit.
4. Insert the IP address of that unit.
5. Modify the port if necessary.

6. Insert the username.
7. Insert the password.
8. Check the **Save Password** option.
9. Click the **Test Server** button to test the connection between the local application and the remote unit.
10. Click the **Add** button to add this unit into the remote server list.
11. Click the **OK** button.
12. Click the ▼ button next to **Remote Server Site** button, and select one of servers you added.

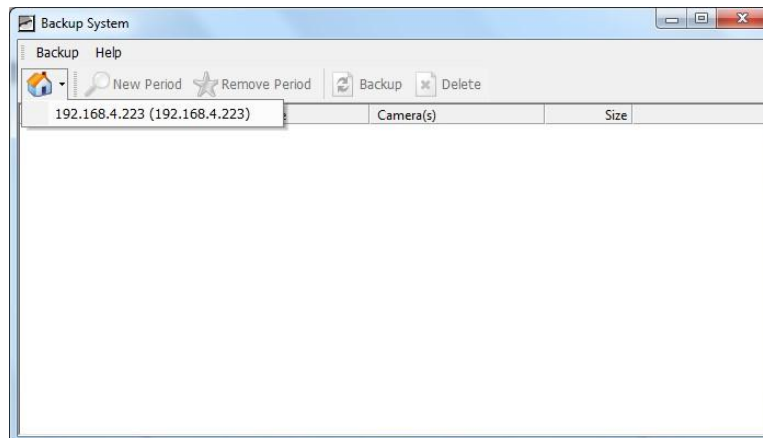

13. Click the **New Period** button to select the record date.

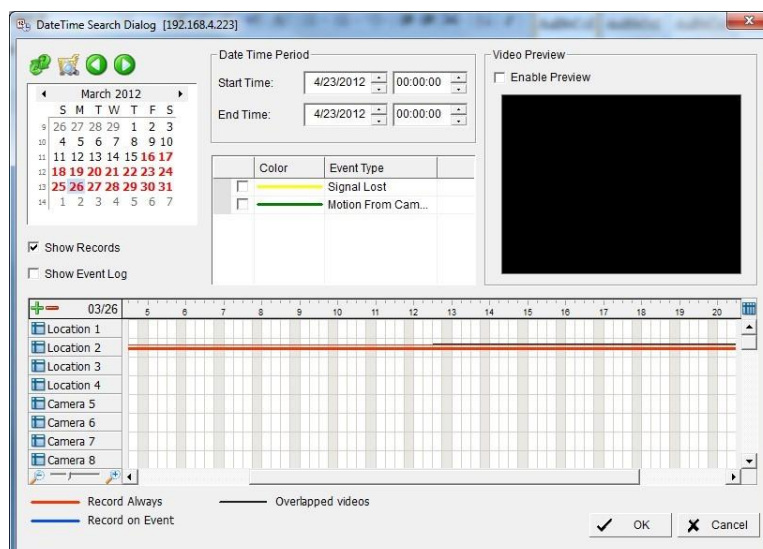

14. Set the Start Time and End Time you want to backup. (or highlight the video records which you want to backup)
15. Select the cameras you want to backup.
16. Click the **OK** button.

17. Select the time slot which you want to backup.

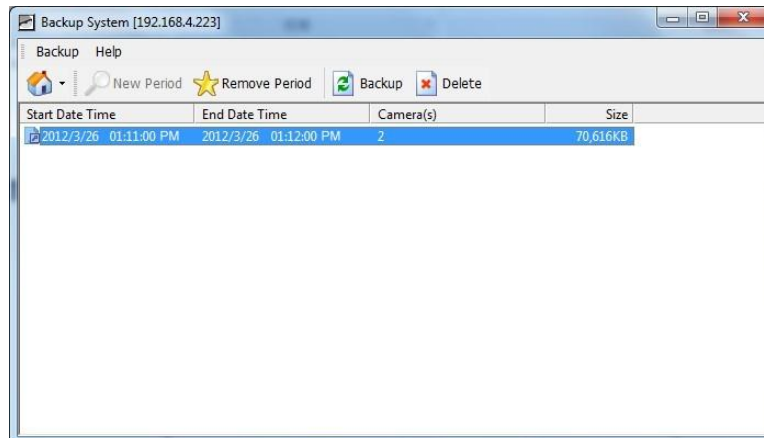

18. Click the **Backup** button.

19. Select the way and directory you want to save the backup data.

20. Check the **Include Playback application** option, which will add **Playback** application into the backup folder.

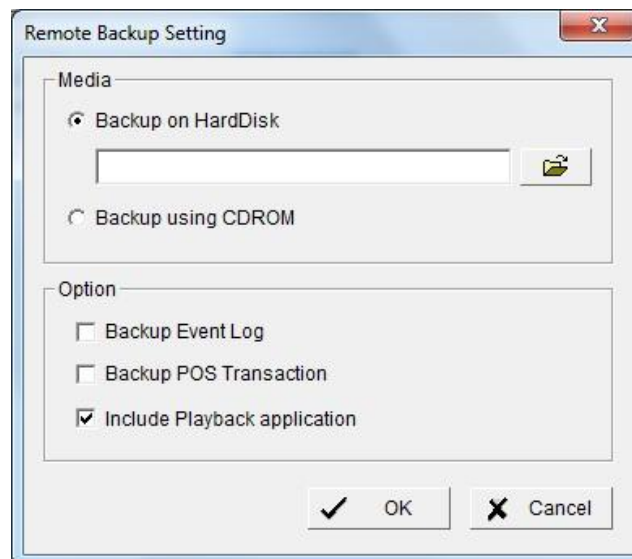

21. Click the **OK** button.

7.2 Backup the Recorded Video through Windows Explorer

1. Find your unit through Windows Explorer (insert "\\\" plus the IP address of your unit)
2. Open the "public" folder.
3. Insert the name and password of the administrator.

4. Select the volume and open the "VIDEODATA" folder.
5. Copy the date folder which you want to backup to your desktop / laptop.

7.3 Backup the Recorded Video through FTP

1. Find your unit through Windows Explorer (insert "ftp://" plus the IP address of your unit)
2. Insert the name and password of the administrator.
3. Select the volume and open the "VIDEODATA" folder.
4. Copy the date folder which you want to backup to your desktop / laptop.

7.4 Playback the Backup Records

7.4.1 With Playback Application

1. Use the Backup System application to backup your records.
2. Check the **Include Playback application** option, which will add the **Playback** application into the backup folder.
3. Open that folder.
4. Double-click the Playback application icon.
5. Select the recorded data to play back.

7.4.2 Without Playback Application

1. Use the Playback function to backup your records.
2. Put your backup folder into the program folder of NVR. (Default directory is "C:\Program Files\NVR".)
3. Startup > NVS > Playback System.
4. Click the **Open Record** button.
5. Select the recorded data to play back.

7.5 Delete the Recorded Video

7.5.1 With Backup Application

1. Startup > NVS > Backup System.

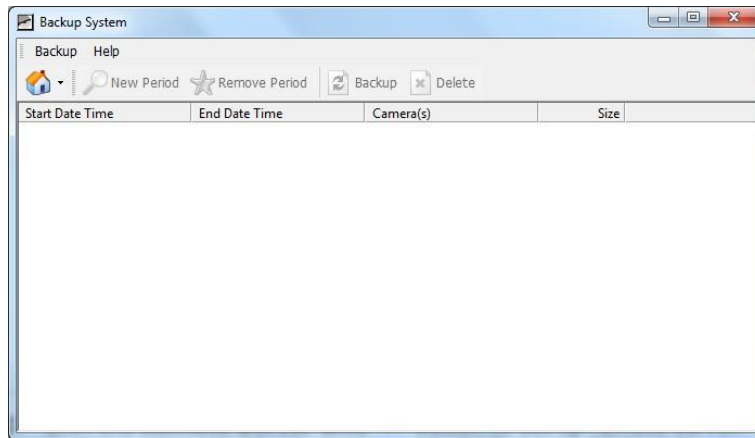

2. Click the **Remote Server Site**  button to set up remote server.

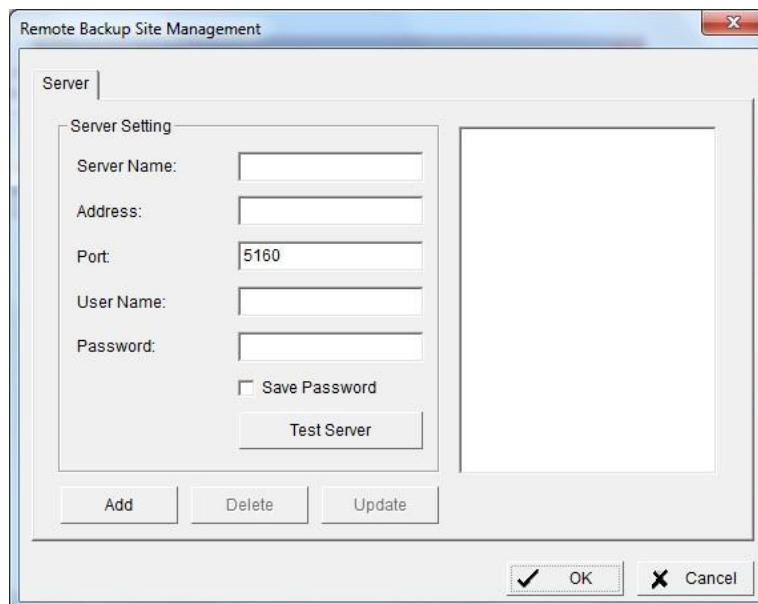

3. Insert the name of your unit.
4. Insert the IP address of that unit.
5. Modify the port if necessary.
6. Insert the username.
7. Insert the password.
8. Check the **Save Password** option.
9. Click the **Test Server** button to test the connection between the local application and the remote unit.
10. Click the **Add** button to add this unit into the remote server list.
11. Click the **OK** button.
12. Click the ▼ button next to **Remote Server Site** button, and select one of servers you added.

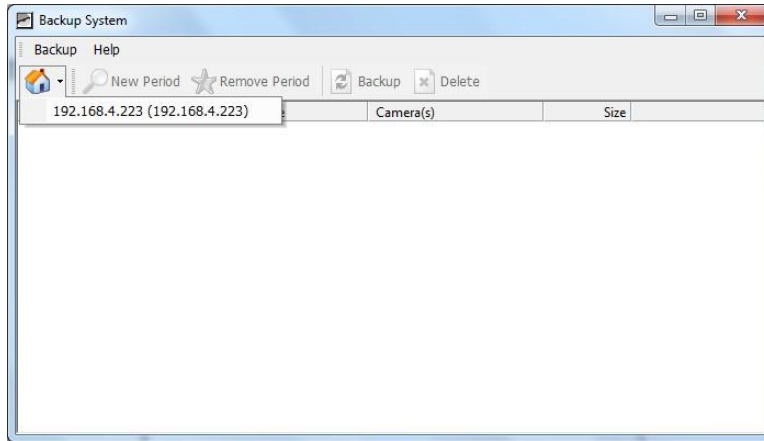

13. Click the **New Period** button to select the record date.

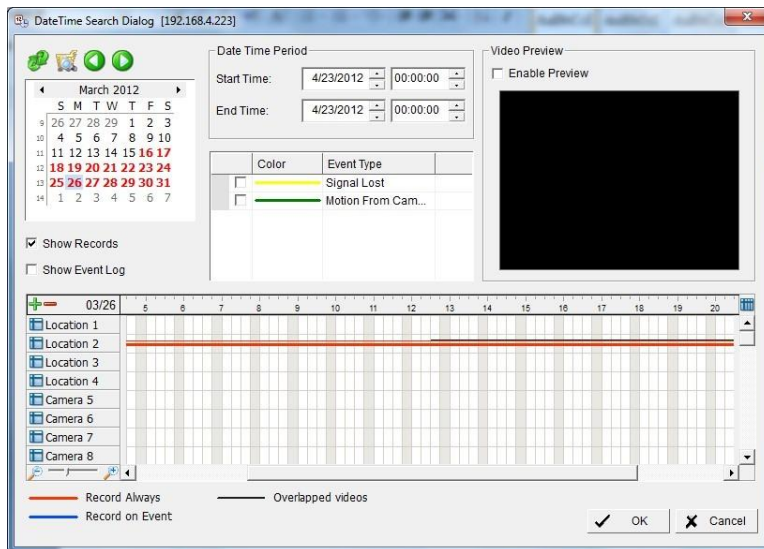

14. Set the Start Time and End Time. (or highlight the video records which you want to delete)

15. Select the cameras you want to delete the records.

16. Click the **OK** button.

17. Select the time slot which you want to delete.

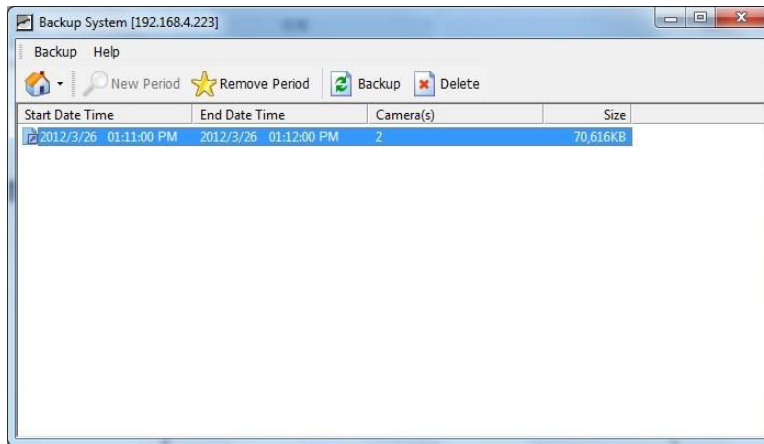

18. Click the **Delete** button.
19. Confirm the check dialog.

7.5.2 Without Backup Application

1. Find your unit through Windows Explorer (insert "\\\" plus the IP address of your unit).
2. Open the "public" folder.
3. Insert the name and password of the administrator.
4. Select the volume and open the "VIDEODATA" folder.
5. Select the date folder which you want to delete.
6. Delete the folder.



In order to keep the system stable, do not delete recorded data from the day in which you do the delete process.

8.Verification Tool

The Verification Tool verifies whether the data created by the system has been tampered with. It's the process by which a digital watermark (a digital signature) is added to each recorded video frame to ensure its authenticity.

There are three types of data could be verified by Verification Tool:

1. File in (.dat) (.264) format will be displayed as 📹.
2. File in (.avi) (.asf) format will be displayed as 🎞️.
3. File in (.bmp) (.jpg) format will be displayed as 🖼️.

8.1 Execute Verification Tool

1. Startup > NVS > Verification Tool.
2. Verification Tool Overview

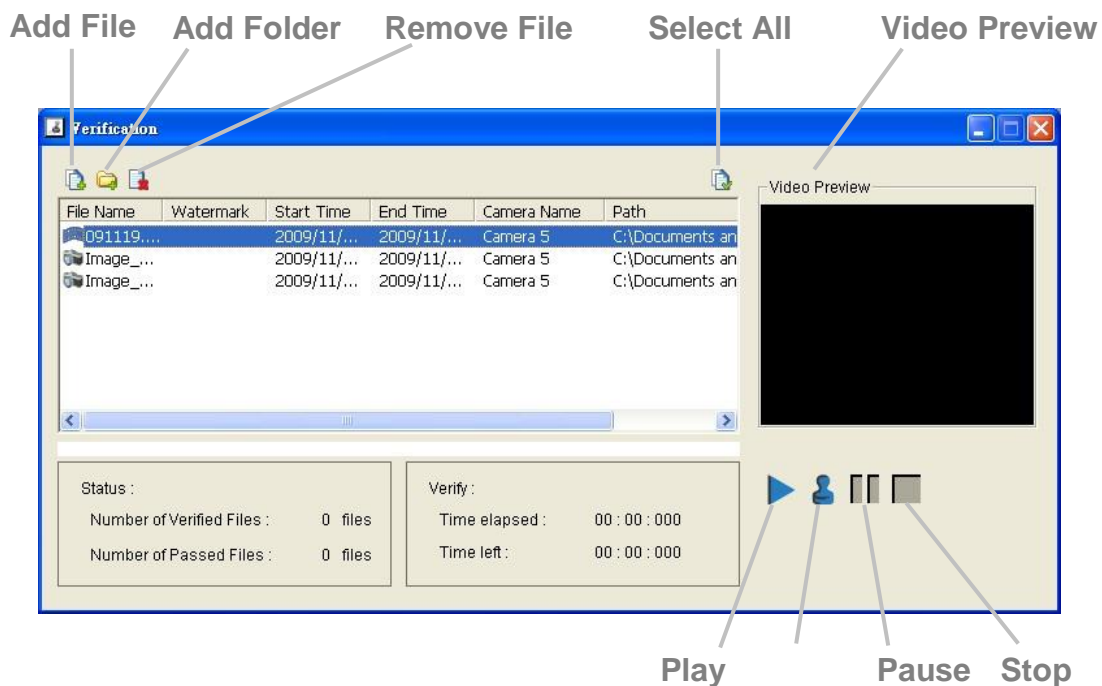

- **Add File:** Insert the single file to list for verification.
- **Add Folder:** Choose the folder with multiple files to list for verification.
- **Remove File:** Remove indicated file(s) from list.
- **Select All:** Select all files in list for verification.



Choose the file type first before selecting files. Only (.dat) (.264) (.avi) (.asf) (.bmp) (.jpg) are available to open.

- **Video Preview:** Preview designate file in verification list. Select the buttons below to play ▶, pause ||, and stop ■ the video file.

8.2 Verify Image / Video

1. Select single or multiple files for verification.
2. Click the **Verify** button to start verification.
3. The verification result will show on watermark column. If a file was tampered with, it will show ❌; if a file passed verification, it will show ✅.

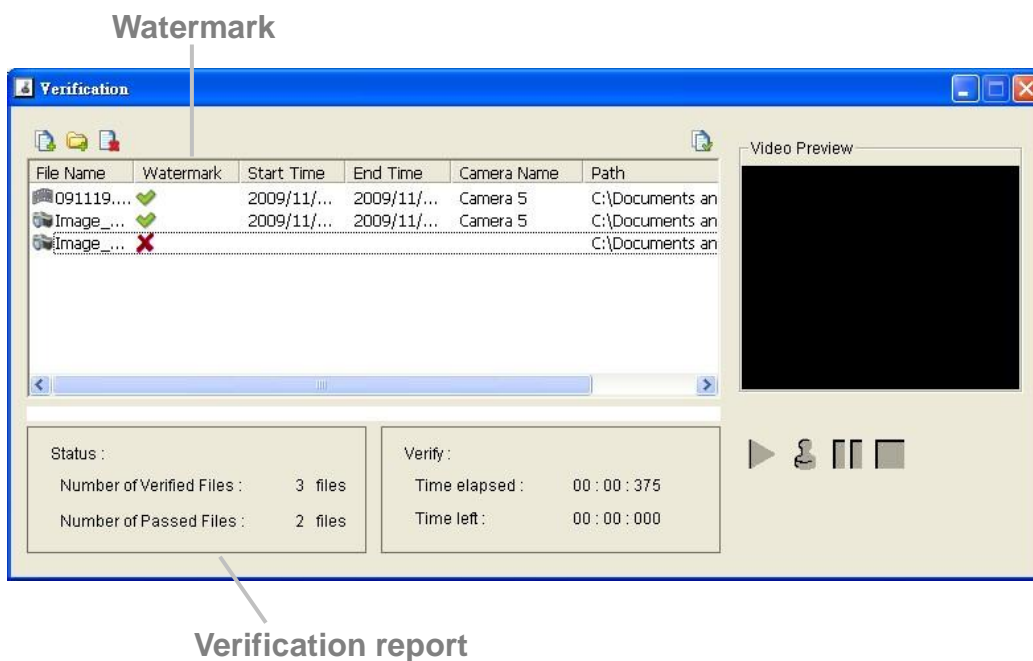

4. The verification report will indicate the information related to the verification.

9. External Storage

Total recording space can be expanded largely by connecting DAS through eSATA port. Follow the directions to enlarge your recording space.

9.1 Create a Volume on DAS

The current compatible DAS is AXUS FiT Series. We don't guarantee the quality of other DAS models. Please refer to the manual of AXUS FiT Series to create a single volume on DAS.



We are unable to create a volume on external storage in NVR setting page, so do NOT skip this step before connecting to NVR device.

9.2 Create an External Storage

1. Log in to the unit.
2. Click **RAID & File System / RAID Management**.
3. You will find External SATA Disk displayed in Disk List.

The screenshot shows the RAID Management interface. At the top, there are tabs for RAID Status, Modify, Create, Delete, and Format. The RAID Status tab is active. Below the tabs, there is a 'RAID Status' section with a 'List' table. The table has two columns: 'List' and 'Status'. The 'List' column shows a tree view with 'Volumes' containing 'VOLUME1' and 'Disk 1', and 'Free Disks' containing 'Disk 6 (eSATA)'. The 'Status' column shows details for 'VOLUME1': RAID Name: VOLUME1, RAID Level: RAID0, RAID Status: Functional, Total Capacity: 931.51 GB (953868 MB), Free Capacity: 583.5 GB (597504 MB), Used Capacity: 333.39 GB (341392 MB), Usage: 37% (indicated by a red progress bar), Update Time: Tuesday, August 16, 2011 2:56:17 AM, Total Devices: 1, Active Devices: 1, Failed Devices: 0, Spare Devices: 0, Format Progress, and Recovery Progress.

4. Click on the eSATA disk directly to check the disk drive information.

RAID Management

RAID Status Modify Create Delete Format

RAID Status

List	Status
Volumes	Vendor Seagate
VOLUME1	Model ST32000542AS
Disk 1	Capacity 1929GB
Free Disks	Firmware Version 0957
Disk 6 (eSATA)	Serial No. 6RY6GK1T
	Smart Support Yes
	Smart Enable Enable

Refer to the section of **Create a RAID Volume** to create a volume for it. To avoid any connection problem, we suggest users creating an isolate volume with eSATA disk only.

10. Log out

Click the **Logout** button on the top of the page to log out of the system. If there is no action in 10 minutes, the system will log out automatically to avoid unauthorized access.

11. Remote PC System Requirements

Remote PC Minimum Requirements	
Model	1 bay
OS Supported	Windows XP 32 bit, Windows 7 32/64 bit
CPU	Intel Core 2 Duo, 2.6GHz
RAM	1GB
User Interface	1. HTTP Web browser - Internet Explorer 8 and later 2. NVR Client application program

12. Troubleshooting

12.1 Replace a Failed Disk Drive

If a disk drive fails, the Disk Status LED becomes orange. If the disk drive belongs to a RAID Volume, the Volume goes Critical or Offline, depending on RAID level. See [Check RAID Volume Status](#) for details.

Replace the failed disk drive with a new disk drive of the same or slightly greater capacity. You do not have to power down the unit. Refer to [Modify RAID Volume](#) to remove the failed disk and replace it with a new one.

12.2 Respond to a Critical RAID Volume

How the unit responding to a Critical RAID Volume depends on the RAID level of your Volume:

- For **RAID 1, 5, and 10** volumes, you must replace the failed disk drive with a new one. The RAID Volume will begin rebuilding itself when you install the new disk drive. See [Replace a Failed Disk Drive](#) for details.
- **RAID 0** volumes go offline after a disk drive failure. A **RAID 0** Volume cannot be recovery. All data of the volume is lost.

12.3 Respond to a File System Error RAID Volume

When encountering file system error, you are unable to keep the data anymore. It's likely due to abnormal usage and disk damage. In this case, if you want to keep recording, we suggest replacing new disks, or try the following methods.

1. Format this volume, and check if the status becomes **functional**. If yes, you can start recording. If it doesn't, try the second method.
2. Delete this volume, and create volume again to see if the status is **functional**.

12.4 Restore the Default Administrator's Password

If you forget the password, and want to reset the Administrator's password to the default password: **admin**, follow the following steps.

1. Verify that the system is fully booted.
2. Insert your reset tool into the reset button hole on the back of the device.
3. Press and hold the reset button for 8 seconds, release your hands until the

- buzzer beeps one time and the System Status LED flashes in blue.
4. System will restart and the Administrator's password is now reset to **admin**.

12.5 Restore All Default Configuration

If you want to restore all configurations to default setting, follow the following steps.

1. Verify that the system is fully booted.
2. Insert your reset tool into the reset button hole on the back of the device.
3. Press and hold the reset button for 14 seconds, release your hands until the buzzer beeps twice and the System Status LED flashes in orange.
4. System will restart and all settings are reset to default.



RAID volume and data within the volume won't be reset to default. Refer to **[Format](#)** for the details.

12.6 Install ActiveX

If you cannot see the complete page of the system when using Internet Explorer, it may be because the ActiveX installation process is not completed.

1. Open Internet Explorer and log in to the unit.
2. Click the **Live view / Playback** button on the top right.
3. The browser will ask whether to install ActiveX.

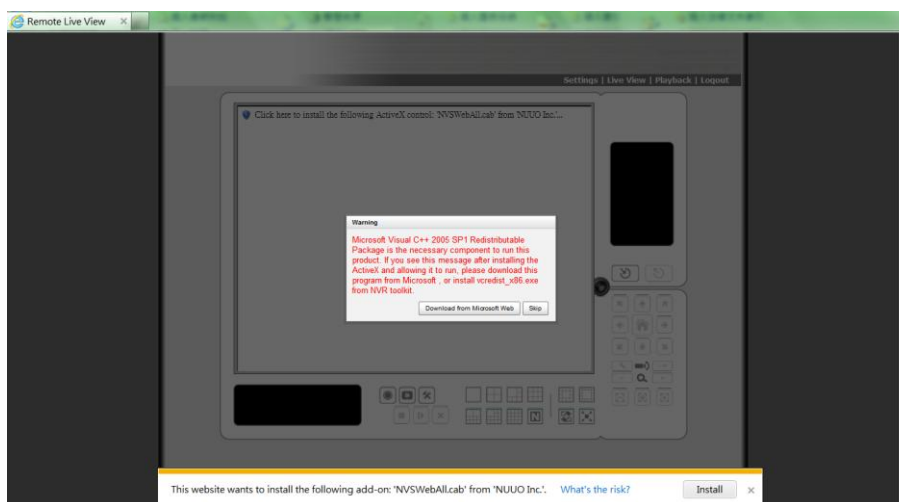

4. Click the upper bar to begin the installation process.

5. Click the **Install** button to complete the process.

12.7 Cannot Log in to the Unit with Internet Explorer

1. Check the settings of your antivirus software.
2. Change to appropriate settings or turn off this antivirus software.

Appendix – RAID System

Introduction to RAID

RAID (Redundant Array of Independent Disks) allows multiple disk drives to be combined together into a RAID Volume. You will create a RAID Volume on your unit when you perform the setup procedure.

The benefits of a RAID can include:

- Higher data transfer rates for increased server performance
- Increased overall storage capacity for a single Volume
- Data redundancy/fault tolerance for ensuring continuous system operation in the event of a disk drive failure

Different RAID levels use different organizational models and have varying benefits. The following outline breaks down the properties for each RAID level supported on this unit:

RAID 0 – Stripe

When a RAID Volume is striped, the read and write blocks of data are interleaved between the sectors of multiple disk drives. Performance is increased, since the workload is balanced between drives or “members” that form the RAID Volume. Identical drives are recommended for performance as well as data storage efficiency.

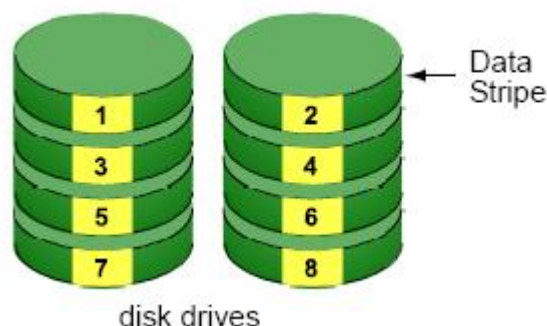

The RAID Volume’s data capacity equals the capacity of the smallest disk drive times the number of disk drives. For example, one 100 GB and three 120 GB drives will form a 400 GB (4 x 100 GB) RAID Volume instead of 460 GB.

If disk drives of different capacities are used, there will also be unused capacity on the larger drives.

Because RAID 0 does not offer Fault Tolerance, meaning that you cannot recover your data after a disk drive failure, we do not recommend a RAID 0 Volume for your unit.

RAID 0 Volumes on this unit consist of one or more disk drives.

RAID 1 – Mirror

When a RAID Volume is mirrored, identical data is written to a pair of disk drives, while reads are performed in parallel. The reads are performed using elevator seek and load balancing techniques where the workload is distributed in the most efficient manner. Whichever drive is not busy and is positioned closer to the data will be accessed first.

With RAID 1, if one disk drive fails or has errors, the other mirrored disk drive continues to function. This is called Fault Tolerance. Moreover, if a spare disk drive is present, the spare drive will be used as the replacement drive and data will begin to be mirrored to it from the remaining good drive.



The RAID Volume's data capacity equals the smaller disk drive. For example, a 100 GB disk drive and a 120 GB disk drive have a combined capacity of 100 GB in a mirrored RAID Volume.

If disk drives of different capacities are used, there will also be unused capacity on the larger drive.

RAID 1 Volumes on this unit consist of two disk drives.

If you want a mirrored RAID Volume with more than two disk drives, see **RAID 10 – Mirror / Stripe** for details.

RAID 5 – Block Striping with Distributed Parity

RAID 5 organizes block data and parity data across the disk drives. Generally, RAID level 5 tends to exhibit lower random write performance due to the heavy workload of parity recalculation for each I/O. RAID 5 works well for file, database, application and web servers.

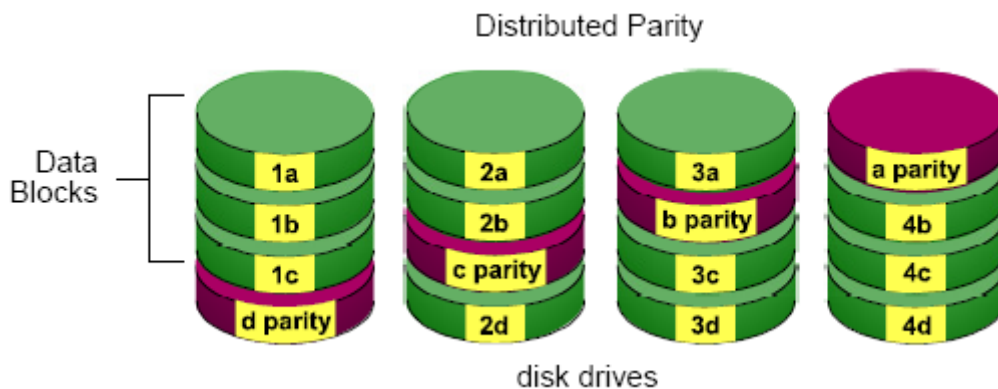

The capacity of a RAID 5 Volume equals the smallest disk drive times the number of disk drives, minus one. Hence, a RAID 5 Volume with four 100 GB disk drives will have a capacity of 300 GB. A RAID Volume with two 120 GB disk drives and one 100 GB disk drive will have a capacity of 200 GB.

RAID 5 is generally considered to be the most versatile RAID level.

RAID 5 requires a minimum of three disk drives.

RAID 10 – Mirror / Stripe

Mirror/Stripe combines both of the RAID 0 and RAID 1 types. RAID 10 can increase performance by reading and writing data in parallel while protecting data with duplication. At least four disk drives are needed for RAID 10 to be installed. With a four-disk-drive RAID Volume, one drive pair is mirrored together then striped over a second drive pair.

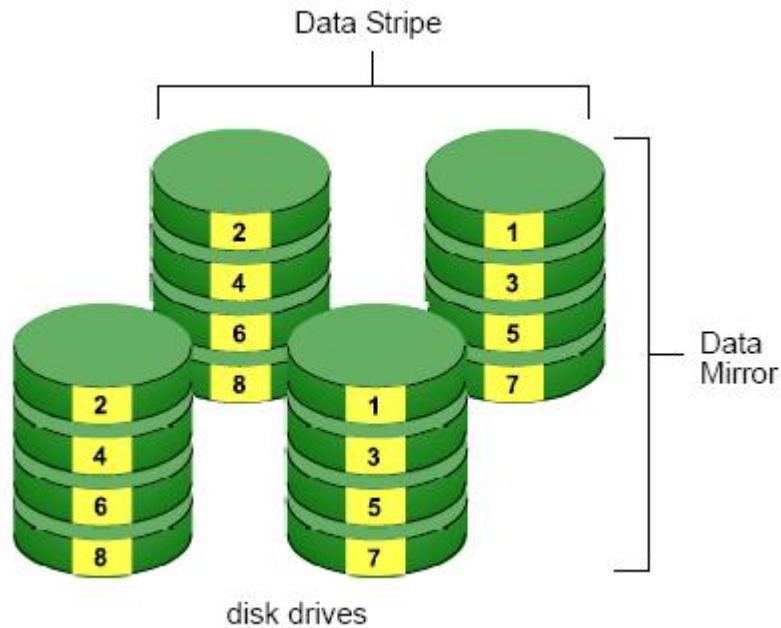

The data capacity RAID 10 Volume equals the capacity of the smallest disk drive times the number of disk drives, divided by two.

In some cases, RAID 10 offers double fault tolerance, depending on which disk drives fail.

RAID 10 Volumes on this unit consist of four disk drives.

Because all of the available disk drives are used for the RAID Volume, you cannot set up a spare drive with RAID 10.

Choosing a RAID Level

There are several issues to consider when choosing the RAID level. The following summarizes some advantages, disadvantages and applications for each choice.

- **RAID 0**

Advantage	Disadvantage
<ul style="list-style-type: none"> ● Implements a striped disk RAID Volume, the data is broken down into blocks and each block is written to a separate disk drive ● I/O performance is greatly 	<ul style="list-style-type: none"> ● Not a true RAID because it is not fault tolerant ● The failure of just one drive will result in all data in a RAID Volume

<p>improved by spreading the I/O load across many channels and drives</p> <ul style="list-style-type: none"> ● No parity calculation overhead is involved 	<p>being lost</p> <ul style="list-style-type: none"> ● Should not be used in mission critical environments
--	---

- **RAID 1**

Advantage	Disadvantage
<ul style="list-style-type: none"> ● Simplest RAID storage subsystem design ● Can increase read performance by processing data requests in parallel since the same data resides on two different drives 	<ul style="list-style-type: none"> ● Very high disk overhead - uses only 50% of total capacity

- **RAID 5**

Advantage	Disadvantage
<ul style="list-style-type: none"> ● High Read data transaction rate ● Medium Write data transaction rate ● Good aggregate transfer rate ● Most versatile RAID level 	<ul style="list-style-type: none"> ● Disk failure has a medium impact on throughput

- **RAID 10**

Advantage	Disadvantage
<ul style="list-style-type: none"> ● Implemented as a mirrored RAID ● Volume whose segments are RAID 0 RAID Volumes ● High I/O rates are achieved thanks to multiple stripe segments 	<ul style="list-style-type: none"> ● Very high disk overhead – uses only 50% of total capacity