Digital Video Recorder

User's Manual

WMPR 04/08/16

Thank you for using our product.

1. This is user's manual for H.264 4CH, 8CH and 16CH Wall Mount DVR (Digital Video Recorder).
2. This manual contains product specification and introduction, installation guide, operating guide and other necessary matters for easy understanding. Users should read this user's manual carefully for proper use.
3. Contents in this manual may be changed according to the specification change and feature improvement without any notification.
4. This user's manual shall never be copied without prior agreement and violating this may be a reason for legal punishment on piracy.
5. If there is any incorrect or insufficient content in this user's manual, notify it to Customer Support Center.

Contents

CH 1. Product Introduction

1-1. Product Contents	5
1-2. Specifications	6
1-3. Product Characteristics	7
1-4. Name of Each Part	9

CH 2. Installation Guide and Cautions

2-1. Cautions	12
2-2. Product Installation	15
2-2-1. Install	15
2-2-2. Connection	15

CH 3. How to Use

3-1. General Usage Information	19
3-2. Live Mode	20
3-2-1. Live mode control	20
3-2-2. Live mode feature	22
3-3. Search Mode	26
3-3-1. Search selection type	26
3-3-2. Play mode	28
3-4. Setup Mode	29
3-4-1. Display	29
3-4-2. Record	31
3-4-3. Device	36
3-4-4. Network	40
3-4-5. System	43

Contents

CH 4. Client Program	46
4-1. Installing Client Program	46
4-2. How to use Client Program	51
4-2-1. Initial Screen	52
4-2-2. Connecting the DVR	56
4-2-3. Initial Screen after connection	57
4-2-4. WATCH-live viewing	58
4-2-5. Favorite – multiple DVR connection	59
4-2-6. SEARCH-playback	62
4-2-7. SETUP-remote setup of DVR	66
4-3. Firmware Upgrade	67
4-4. Web browser Monitoring and Playback	69
Trouble Shooting	70
Warranty	71

CH1. Product Introduction

1-1. Product Contents

After removing packing materials of this product, check whether all following contents are included.

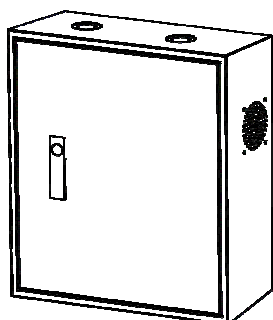

Main Body (DVR):

This converts the analog video and audio signal to the digital signal and saves on HDD.



Wireless Mouse

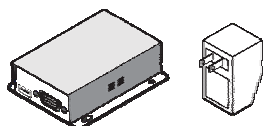

Receiver and Adapter

This is placed on your desk for remote control and monitoring. The adapter spec is 12V 1.5A.



Program CD:

This contains the User's manual and Client Program for DVR.



Remote Controller:

This is an IR remote controller for convenience.



Battery:

These are 2(two) battery for the remote controller.

1-2. Specifications

Image Input/Output : NTSC / PAL

Recording Speed :

NTSC - 1~120fps(4ch/D1), 1~240(8ch/Half D1), 1~480fps(16ch/CIF)

PAL - 1~100fps(4ch/D1), 1~200(8ch/Half D1), 1~400fps(16ch/CIF)

Compression Method : H.264 Technology

Power : AC 90~120V, 200~230V

Power Consumption : 200W

External Terminal : Video Input - BNC 4CH/BNC 8CH/BNC 16CH

Video Output - BNC 1CH, Extension 1CH

Audio Input - RCA 4CH

Audio Output - RCA 1CH

Sensor Input - Terminal Block 16CH (TTL)

Sensor Output - Terminal Block 16CH (1Dry Contact, 15 TTL)

LAN Communication - RJ45 Port

Serial Communication - Terminal Block(RS485)

USB 2.0 Type A

Temperature : 5~40°C (30~110 F)

Humidity : 20%~80%(Non-condensing)

Size : 470(W) × 160(D) × 520(H) mm

Weight : 15Kg(Supplements and Packing Materials Excluded)

Supplements : Wireless Mouse 1

Receiver 1

Adapter 1

Power Cable

Program CD 1

Remote Controller 1

Battery 2

1-3. Product Characteristics

1) High quality picture

This enables recording and playing high quality digital image based on H.264 compression method.

2) High reliability

With Embedded hardware and software design, this maintains higher product reliability compared to common PC type products.

3) Simple usage

This allows users to use it conveniently by placing control buttons similar to existing ones on VCR, and users can easily learn the usage.

4) Triplex System

Triplex System allows recording, backup, networking and playback simultaneously.

5) Selectable recording setup

For recording methods, users can select the frame rate, resolution and video quality individually in order to be appropriate for user's environment.

6) Remote monitoring

With using exclusive line or Internet network, you can search or monitor recorded images remotely by installing exclusive client program on PC.

7) Backup

You can backup with USB or external ODD.

8) Audio recording

You can record four sound inputs simultaneously. Moreover, you can listen to the sound in search and live monitoring and play mode.

9) Various recording methods

This provides convenient use with manual recording, recording by dates and days, hourly schedule recording, sensor and motion detection event recording and others to enable unmanned monitoring.

10) Various total monitoring features

You can use overall and economical security system through various sensor inputs and contact output control.

11) Display information in easy-to-understand information method

This enhanced convenience of user by displaying information (date, time, recording method, recording frame number, HDD capacity and others) in monitoring, recording and playing mode in easy-to-understand way.

12) P/T/Z control

By built in RS485, various P/T/Z cameras can be used.

13) Individual resolution setting

You can record in each channel by choosing 360X240, 720X240 and 720X480 individually.

14) Dual CODEC for video transmission

DVR can send 120 fps (based on CIF) regardless of the local recording and viewing setup regardless with recording setup.

15) Web browser support

You can monitor and playback the video and control the PTZ camera by internet explorer.

16) Built in S.M.A.R.T.

You can automatically check the health of the hard disk drives.

17) Language pack

Basically DVR has multiple language set, furthermore you can choose the language set if you want.

18) Mirroring

If you install more than two HDDs, you can use the second HDD for backup for maximum fault tolerance.

1-4. Name of Each Part

[Main Body]

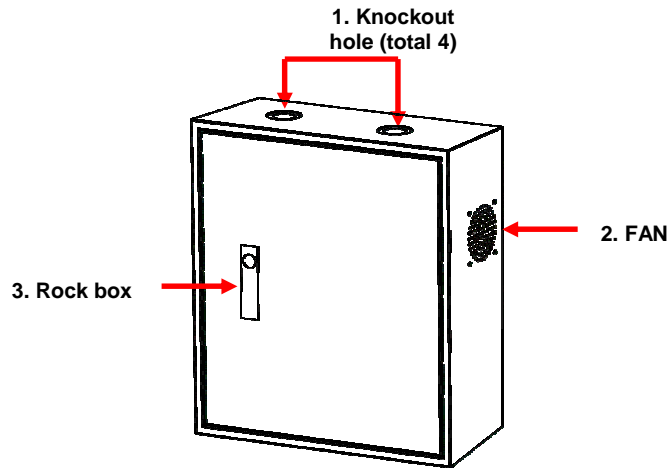

1. Knockout hole : There are 2 holes on the upper side and 2 more on bottom. Each hole has 1 “ and 2 “ holes. You can choose the appropriate size.

2. Cooling Fan

3. Rock box : Easily open just pushing the button.

[Inside]

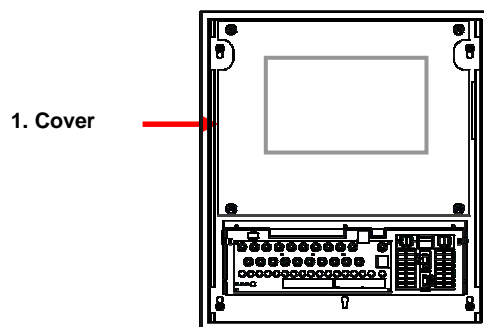

1. Cover : You may install the LCD touch screen monitor on the cover. (Optional)

[Removing Cover]

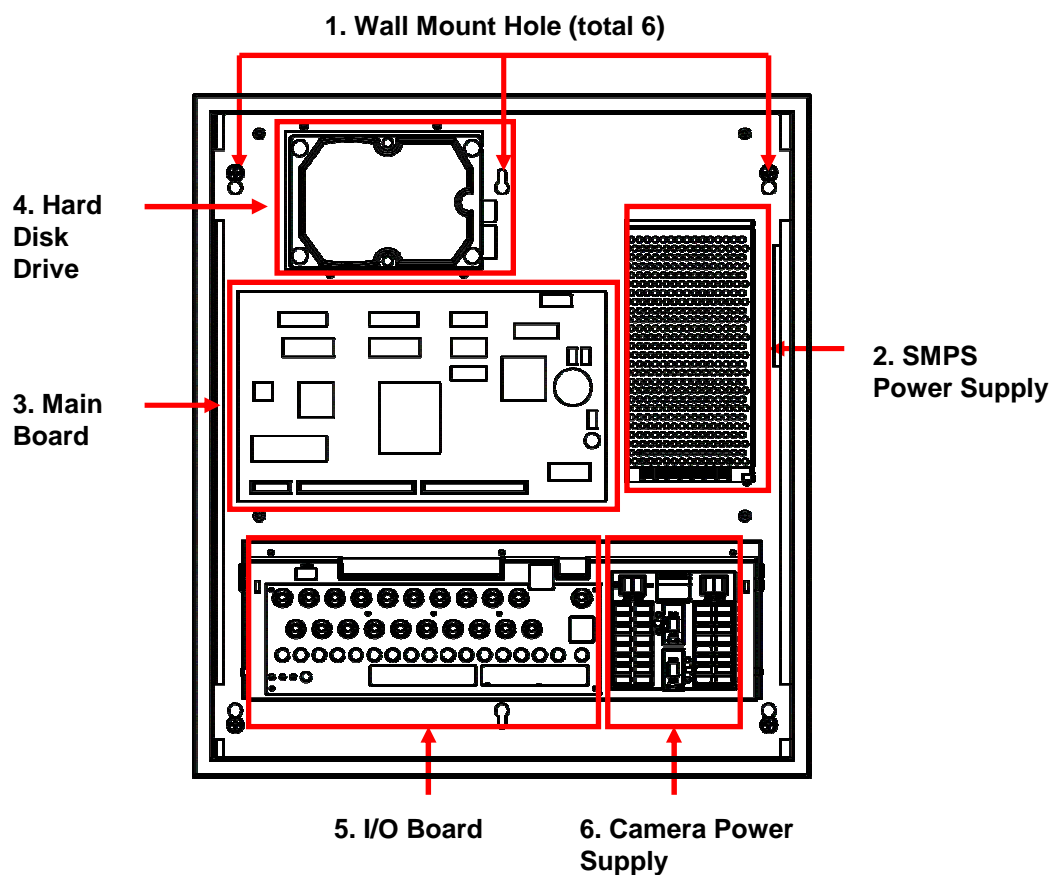

1. Wall Mount Hole : There are 6 holes 16" spacing for install the DVR on the wall
2. SMPS Power supply : 12V 150W (12.5A)
3. Main Board
4. Hard Disk Drive
5. I/O Board : You can install all the camera, audio, sensor and alarm from here.
6. Camera Power Supply : This part provide the power to the camera. You can choose DC12V and AC24V each 8ch separately. You need optional AC power supply if you want supply AC24V.

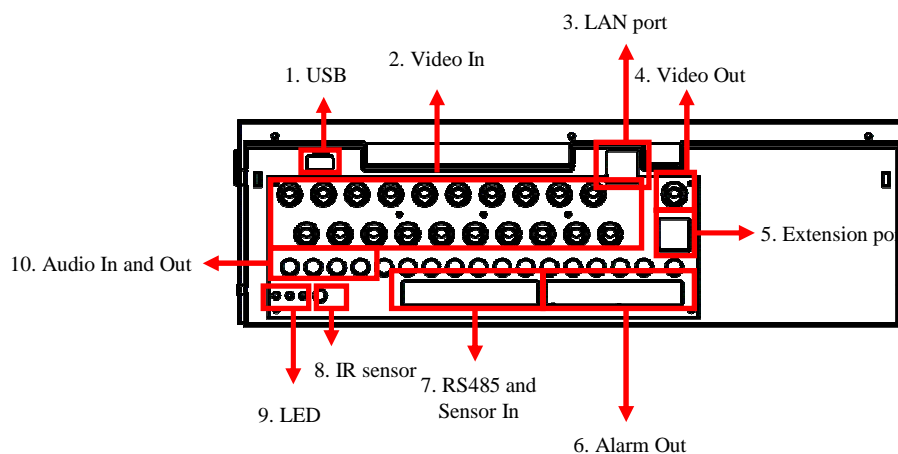
[I/O Board]

1. USB 2.0 for backup and save
2. Video In: This receives images from cameras and sends them to monitors.
3. LAN Port: This is LAN cable connection terminal.
4. Video Out : For CRT monitor.
5. Extension port: video and mouse extension port to Receiver
6. Alarm Out : 1 relay and 15 TTL. This terminal blocks connect external electric devices to the product (Warning Lamp and others).
7. RS485 and Sensor in port : For control the pan and tile cameras. Make sure that the polarity. 16 sensor input. This terminals can be connected to external sensors.
8. IR Sensor : IR sensor for remote controller.
9. LED : Power, Record and Network
10. Audio In and Out: RCA audio in terminals. You can record four channels at the same time.

※ For more details, refer to [CH 2. Installation Method and Cautions].

CH2. Installation Method and Cautions

2-1. Cautions

WARNING
Risk of electric shock.
Do not open the cover of the product.
Servicing of this product by unauthorized personnel is prohibited and will result in a void of warranty.



In order to ensure the most stable conditions for power, the use of a UPS (Uninterrupted Power Supply) is recommended.

- Avoid installing the product where there are direct rays or it is hot by locating near from heat generator. (May cause fire)
- Do not put vase, flowerpot, cup, cosmetics, drug, and anything the contain water on product. (May cause fire or electric shock, and it may injure people by falling)
- Do not insert or drop any metal object (coin, hair pin) or flammable object (match, paper) into air hole. (May cause fire or electric shock)
- Do not put any heavy object on it. (May injure people by being fell or destroyed.)
- Put power plug surely not to be moved. (If not, this may cause fire.)
- Unplug power plug and antenna when there are thunders and lightening. (May cause fire.)
- For cleaning the product, wipe surface with dry towel. Using chemical agent or cleaner may change the color and unpeel paint. Do not put several plugs at same time. (May cause electric shock.) If there is smoke or strange smell, stop operation. In this case, turn the power off and unplug it, and then contact our service center. (If you keep using it, this may cause fire or electric shock.)
- Do not unplug by pulling cord. (If cord is damaged, it may cause fire or electric shock.)
- Do not plug or unplug with wet hands. (May cause electric shock.)

- Keep the power cord untwisted. (May cause fire or electric shock.)
- Use proper adapter. (Using too much electric power may cause fire or electric shock.)
- Do not install it at where exposed to rain and wind and water drop. (May cause fire, electric shock and transformation.)
- Keep away from fire. (May cause fire.)
- Do not disassemble or remodel on your own. (May cause malfunction or electric shock.)
- Do not put next to flammable materials like flammable spray. (May cause fire.)
- Do not install it at a place with too much dirt. (May cause fire.)
- Do not install it on unstable places like shaking table and inclined place or shaking place. (May injure users by falling down or being upside down.)
- Do not put an heavy object on power cord or avoid it from being pressed by the device. (May cause fire or electric shock.)
- In case of using extension cord, do not use several devices at same time. (May cause fire with abnormal heating of extension.)
- When there are dirt on power plug pin or power outlet, clean it nicely. (May cause fire.)
- Do not damage on power cord or plug, and bend or twist or pull too much, and put it between other objects or heat. If power outlet insertion part is not tight, do not use it. (May cause fire or electric shock.)
- Do not drop or give a shock to the product. (May injure people or cause malfunction.)
- Do not touch power adaptor or signal controller. (May cause electric shock.)
- Do not put any object too close to block cooling fan. (May cause fire.)
- In case of exchanging batteries with improper type, there might be danger of explosion.
- For used batteries, throw away separately from other garbage.
- When you take out batteries, avoid children from eating them by mistake. Keep them away from children. (If a child ate them, contact a doctor right away.)

Note :

This equipment has been tested and found to comply with the limits for a Class A digital device, pursuant to part 15 of the FCC Rules. These limits are designed to provide reasonable protection against harmful interference when the equipment is operated in a commercial environment. This equipment generates, uses and can radiate radio frequency energy and, if not installed and used in accordance with the instruction manual, may cause harmful interference to radio communications. Operation of this equipment in a residential area is likely to cause harmful interference in which case the user will be required to correct the interference at his own expense. Changes or modifications to this equipment may cause harmful interference unless the modifications are expressly approved in the instruction manual. The user could lose the authority to operate this equipment if an unauthorized change or modification is made.

This device complies with the part 15 of the FCC Rules. Operation is subject to the following two conditions : (1) this device may not cause harmful interference, and (2) this device must accept any interference received, including interference that may cause undesired operations.

FCC Warning :

This equipment may generate or use radio frequency energy. Changes or modifications to this equipment may cause harmful interference unless the modifications are expressly approved in the instruction manual. The user could lose the authority to operate this equipment if an unauthorized change or modification is made.

CE Warning : This is a Class A product. In a domestic environment this may cause radio interference in which case the user may be required to take adequate measures.

This product has obtained EMI registration.



2-2 Product Installation

This product may be composed of camera and monitor in default, and additionally the sensor, microphone, speaker and PC for network can be connected if necessary.

2-2-1. Install

1. Tighten the screw on the wall, and connect all the cables
2. Install the cover.
3. If you want to adjust the I/O angle, push the button like below.

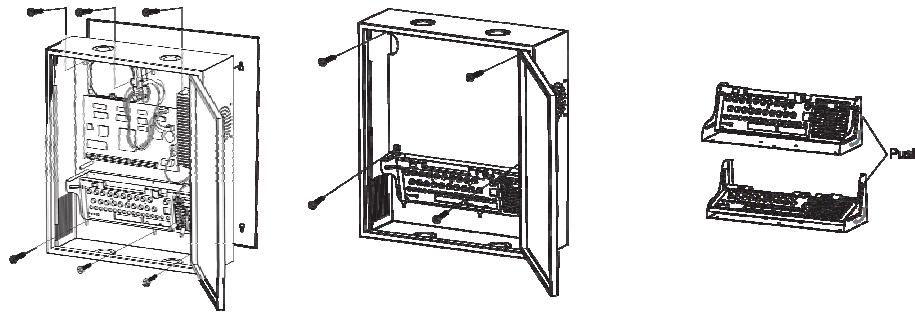

2-2-2. Connection

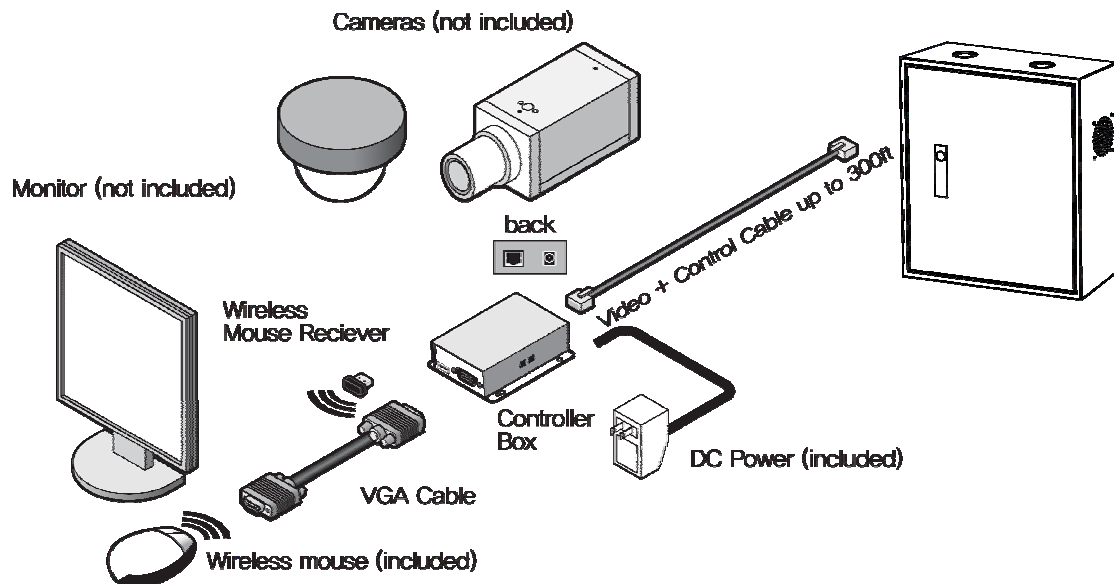

Connecting External Device

- ※ Connect it when power of the product is off.
- ※ Read through user's manual for the device you are connecting carefully.

1) How to Connect External Video/Audio Device

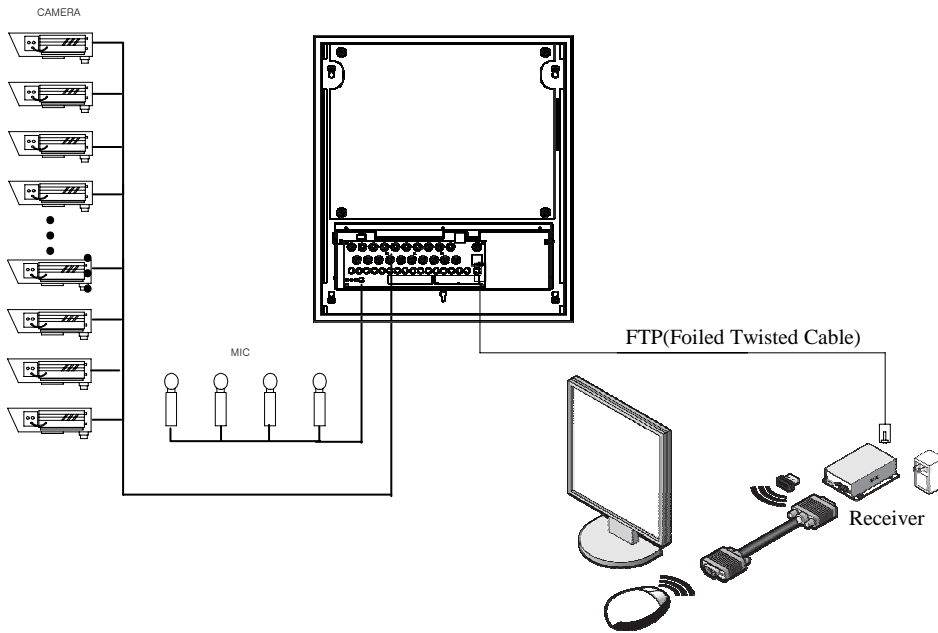

Connect cameras to VIDEO IN by channels.
 Connect microphone (AMP) to AUDIO IN by channels.
 Connect EXTEND FTP cable to Receiver (upto 350ft) Refer to http://en.wikipedia.org/wiki/Twisted_pair about the FTP cable.
 Connect Monitor and Mouse to the Receiver

2) How to connect external sensor

Sensor terminal is composed of 16 input channel and 16 output channel. Alarm out terminal is composed of 1 relay output with 1A, 24V or 0.5A,125V and 15 TTL output.

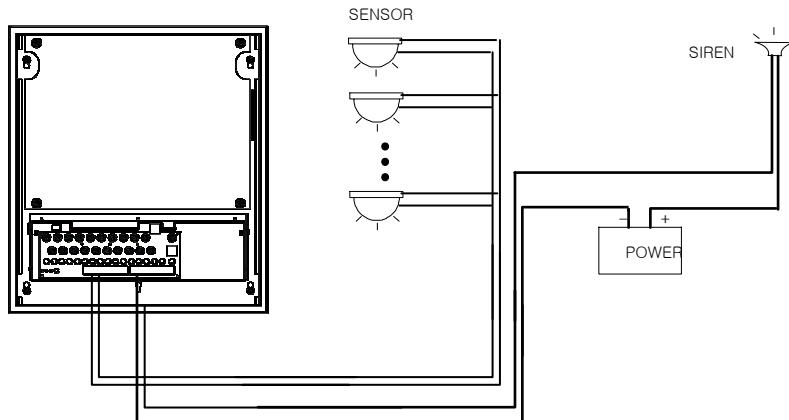

Sensor In : Connect the sensors. The sensor are composed of both signal and ground terminals, with a voltage difference of 5V. In the case that the sensor used for input is of the N/O (Normal Open) type, when the voltage difference between the signal and ground falls to 0V (short), the DVR can use this as a trigger to start alarm/sensor based recording.

Sensor Out : Connecting external electrical devices

The relay alarm terminal does not provide power, and functions only on an ON/OFF basis via a relay. Normally, the signal and ground should be on an OPEN basis, and the DVR will complete the relay connection.

3) Connecting with PC using LAN cable

If you want to connect DVR to PC directly, use LAN cable, and if you want to use HUB, connect cable via hub.

*Hub : This is a device connecting one office to devices located near with using cable when you organize LAN

*Cable : This is standard UTP cable used for communication among devices through Hub and others when you organize LAN

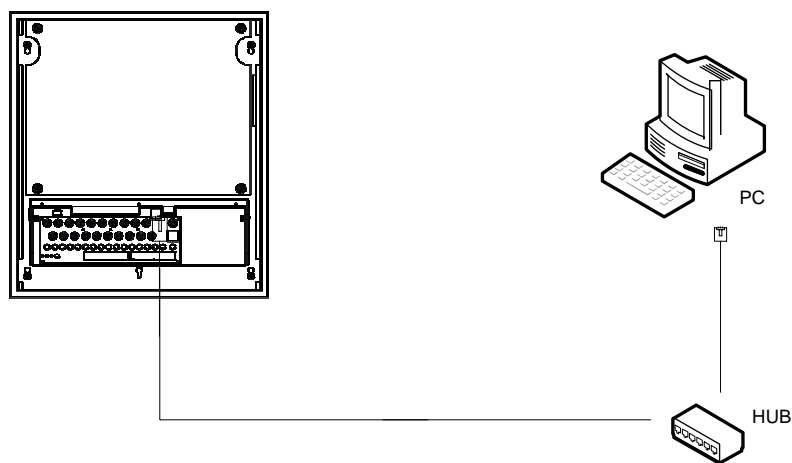

4) Connection Using PTZ camera

In case of using pan and tilt cameras, connect PAN/TILT DRIVE to product as shown at following figure.

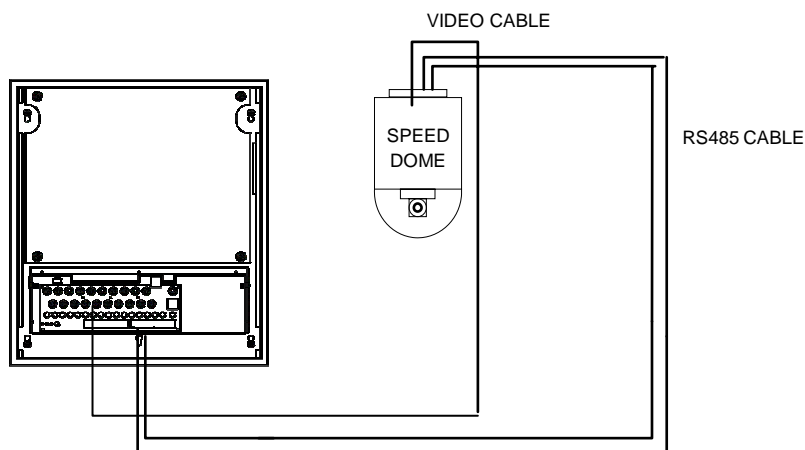

5) Camera Power Supply

You can provided the camera power supply from the DVR. You can choose DC12V and AC24V for your convenience. You can operate separately by 8ch. You may choose DC only, DC 8ch + AC 8ch, and AC only. You need to install the AC 24V power supply for AC power. (Optional)

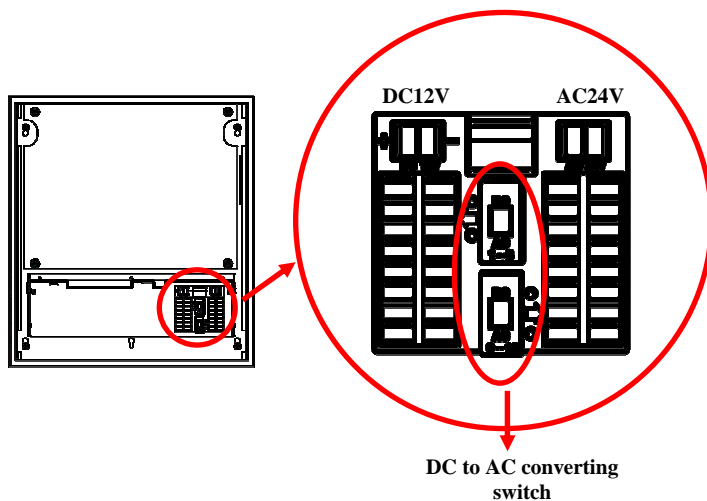

CH3. How to Use

3-1. General Usage Information

The PRESTIGE series DVR can be operated with a mouse or remote controller under the four main modes listed below:

Live Mode – This is the “main or default” mode. From this mode you can view in real time all currently operating cameras, information regarding camera status, and have access to Pan/Tilt camera controls. In addition, system status information will be shown during live mode, and other modes can be entered from Live mode.

Setup Mode – The user will be able to customize settings for Live viewing, Recording, Backup, and Camera related devices under the Setup Mode.

Search Mode – In Search Mode, the user will be able to review all recorded footage in the case that an event must be reviewed using a calendar or event based search.

Backup Mode – In Backup Mode, the user will be able to archive the desired data to the preferred supported media of their choice (ex. CD, DVD, USB Backup, Remote Client Software, etc.)

Password Protection – The DVR system will utilize a user ID and password system to prevent unauthorized usage of this product. Control of the system will only be possible after entering a proper ID and password as illustrated below. (Factory Default settings are blank for these fields).

IDs and passwords should be managed by a system administrator, as different users may be given different levels of access to the DVR.

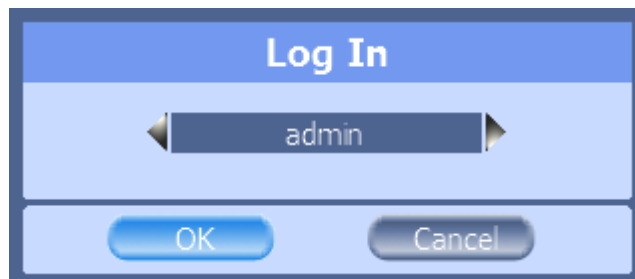

3-2. LIVE Mode





In this section you will know how to split the video mode into 1, 4, 6, 8, 9, 12, 16, as well as auto sequencing, PTZ Control, Mouse control, Setup configurations, Backup



3-2-1. LIVE Mode Control

1) Live View Status









You may use the Live Menu Bar located at the bottom for quick shortcuts and view status of certain items.

	Recording indicator
	Event recording indicator
	Motion detection indicator
	Sensor activation indicator

2) Live Menu Bar

You may use the Live Menu Bar located at the bottom for quick shortcuts and view status of certain items.



	Date
	Time
	Screen Split mode change
	Sequence activation
	Hard drive usage
	Lock/ Unlock indicator
	Scheduler activation indicator
	Audio out channel indicator
	Mute indicator

3) Live Popup Menu

By Right-Clicking anywhere on Live Screen, you may view the Live Popup Menu. By using the Live Popup Menu, you can quickly jump to the necessary configuration and settings.

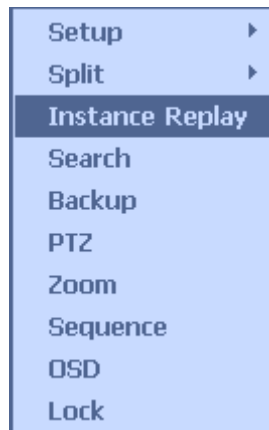

3-2-2. LIVE Mode Feature

1) Split

Change video split mode for Live View.

- 4ch : 1/4 Split Mode
- 8ch : 1/4/6/8/9 Split Mode
- 16ch : 1/4/6/8/9/13/16 Split Mode

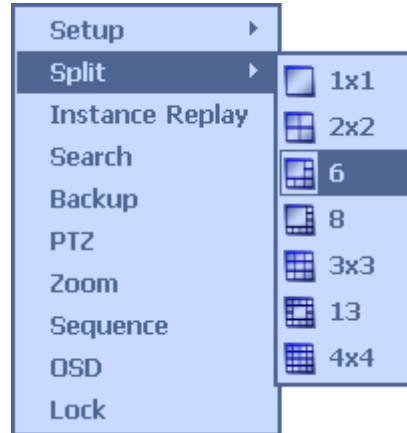

2) Instant Replay

This is very convenient function to catch the abrupt accident. During live viewing, you can go directly to the playback screen.

If you choose the 'Instant Replay', the DVR goes to the 'PLAY' with the present time screen. And you can use the functions related playback.



3) PTZ (Pan, Tilt and Zoom)

It is possible to control the pan and tilt camera by itself. Press the 'PTZ' button to enter the PTZ mode. For Menu setting, you can set it by pressing button as displayed at bottom of window.

- You can set the direction of camera by using the arrow buttons.



- Setup : If you press Setup using mouse (or Menu button on the remote controller) in PTZ Menu, PTZ setup window will appear. You can set the pan and tilt speed, 32 preset name and tour sequence as well as dwelling time,

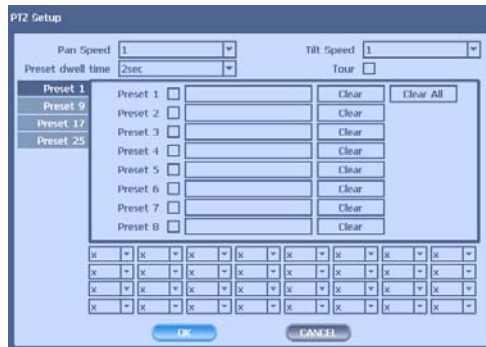

- Zoom In/Out : You can zoom in/out with mouse or play /backward buttons on the remote controller.
- Focus In/Out : You can adjust the focus with mouse or slow buttons on the remote controller.
- Iris In/Out : You can adjust the iris with mouse or ff/rew buttons on the remote controller.

- Preset : You can enter the preset number using the keypad appearing the preset button or 'Enter' button on the remote controller.



4) Zoom

Digital zoom of live screen for selected channel. It can be 2x zoom and also control the position by mouse dragging.

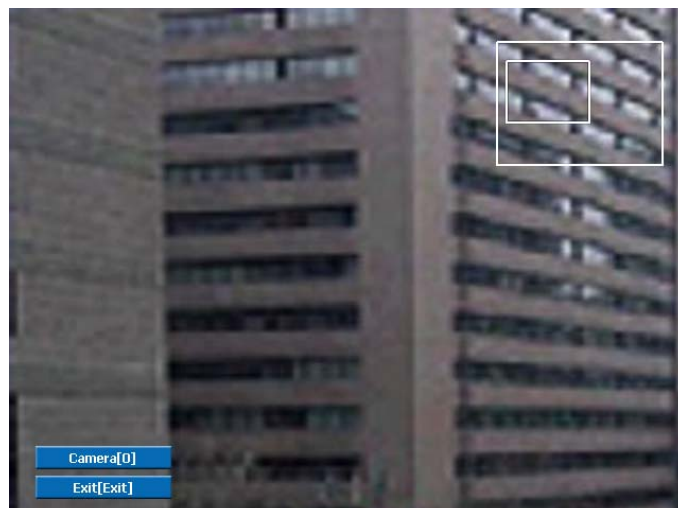

5) Sequence

Sequence Mode On /Off: Switches screens as set on Dwell time under Screen Setup

6) OSD

This feature shows current settings of product through GUI (Graphic User Interface) and INFO button at front side is used for this feature. When you turn on power, this will show current date and time, System Lock Setting, HDD usage, Video Loss Check, Sensor ON/OFF, Motion Detection Check, Recording Status and Schedule Feature Usage. As you press INFO button once more, GUI disappear->OSD disappear->GUI appear->OSD appear will happen sequentially.

- ※ GUI (Graphic User Interface): displaying current status on monitor as images
- ※ OSD (On Screen Display): displaying current status on monitor as character

7) Lock/Log In

Logs off current user and locks DVR from any further configuration and screen setup until next Administrator logs in.

3-3. Search Mode

Search mode consists of two different modes of searching. The video data can be selected by Time or Event.

- Time** Search Month / Day / Time selection.
- Event** Select from Event Log

3-3-1. Search Selection Type

1) Time Based search selection

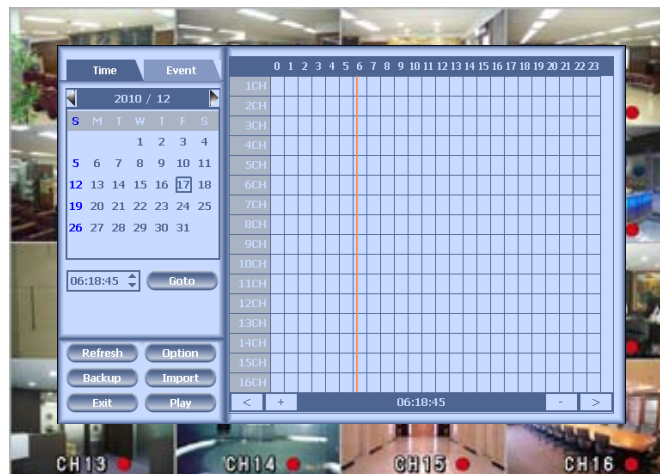

- Select the Date you wish to view by selecting a Date from Calendar
- Select time you wish to view by selecting a time from Time Line
- Preview pane above the time bar will show preview of the currently selected video
- You may click on Refresh, Option, Backup, Import, To Live, To Play for additional features and options

2) Event Based Search Selection

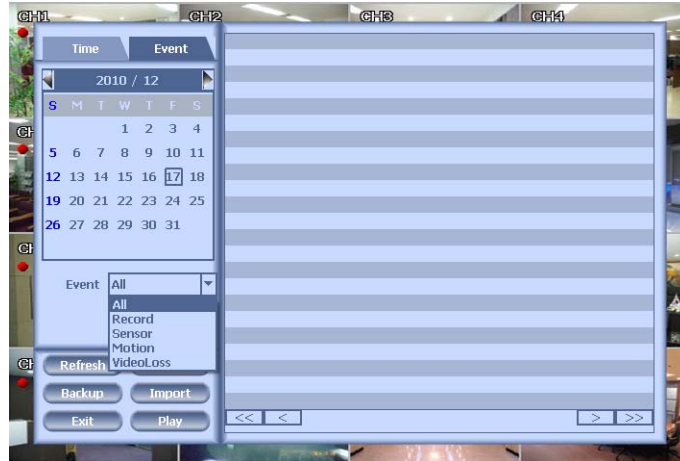

- Select search date from calendar
- Event log will be displayed according to the chosen date
- Preview pane above the Event Log will show preview of currently selected video
- You may click on Refresh, Option, Backup, Import, To Live, To Play for additional features and options

3) Miscellaneous Search Options

	Reload all data list.
	Search option.
	Backup recorded data to external USB device.
	Playback recorded data from external USB device
	Move to Live video mode.
	Load playback data to full screen mode.

3-3-2. Play Mode

If you choose 'to play', the full screen appear. You can control the play speed in here.



► Play Screen GUI

1. Split Screen
2. Sequence
3. FB (Fast Backward): FB×2, 4, 8, 16, 32, 64 times faster
4. Playback : Backward normal speed
5. SB (Slow Backward):SBx1/2, SBx1/4
6. STILL (Pause) / Frame advance
7. SF (Slow Forward):SFx1/2, SFx1/4
8. Play : Forward normal speed
9. FF (Fast Forward): FF×2, 4, 8, 16, 32, 64 times faster
10. STOP : Stops playing and returns to LIVE Screen.
11. Status information

3-4. SETUP Mode

Access Setup menu from Right Clicking mouse button to Popup Menu.
 Configure Display, Record, Device, Network, System which is navigated by clicking on corresponding tab menu at the top of the screen



3-4-1. Display

Configure OSD, Main Display, Color Control setting.

1) OSD

You may configure and/or view Date Format / Time Format / Language / Alpha Blending / OSD / Information Bar options

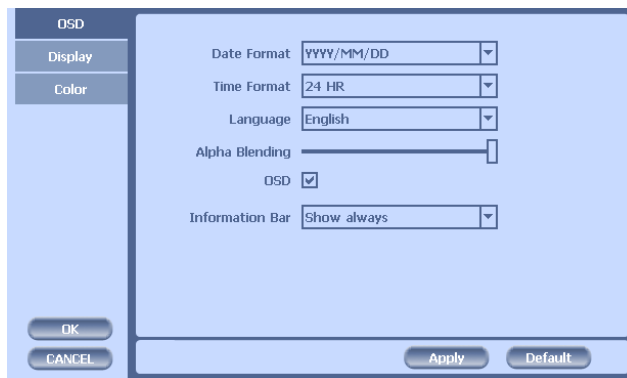

Date Display Format: Select from YYYY/MM/DD, MM/DD/YYYY, DD/MM/YYYY

Time Display Format: 24H – 24hour military time

12H (AM/PM) – 24 Hour separated by AM/PM

Language : Select system language

Alpha Blending: Adjust transparency of System Menus

OSD : OSD On/Off

Information Bar: Information Menu Bar Hide/Auto hide/ Show always

Default : Factory default all configuration values

Apply : Save current page configuration

2) Main Display

Configure and view Monitor, Sequence Dwell Time settings.

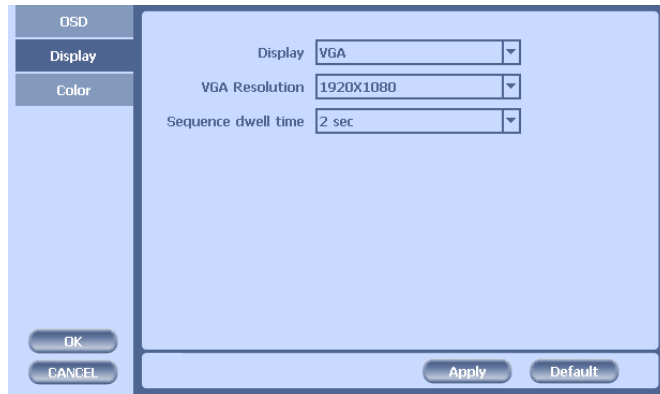

Monitor : You can choose the monitor between VGA and composite. The screen size will be optimized with the selected monitor.

Sequence Dwell Time: Set time for switching.

3) Color Control

Adjust color control for Video.



You can adjust images of camera by channels.

- Contrast: Adjust contrast of camera.
- Brightness: Adjust brightness of camera.
- Saturation: Adjust saturation of camera.
- Hue: Adjust color of camera.

3-4-2. Record

Configure and view Event In, Record, Group, Holiday settings

1) Record

With this menu, you can set the recording variables of DVR and the Scheduler.



1) Rec type: to set conti, event, C/E(conti and event) and none(not recording).

2) Audio Rec: to select audio recording or not.

3) Conti Recording: continuous recording mode setting.

- ① Resolution: There are three kinds of resolutions. Among 360X240(CIF), 720X240(2CIF), 720X480(D1)(OR 360X288, 720X288, 720X576 in PAL), you can set individually.
- ② FPS: Set recording frame rate. 1,2,3,5,6,7.5,10,15,30 are possible within 480fps based on CIF. 2CIF is equivalent 2XCIF and D1 is equivalent 4 times CIF. So there are many combinations under this rule. For example, if in case that ch1 is 2fps/D1, ch2 is 5fps/2CIF and the others is 3fps/CIF, total frame number is $2 \times 4 + 5 \times 2 + 3 \times 14 = 74$. So it is valid. Another useful function is that one channel sets to 30fps/D1 and the others set to 15fps/CIF, total frame rate is 237. So it is also valid. You can check the total number of frames in 'Total'.

- ③ Quality: Set picture quality. As quality gets higher, screen quality gets better but saving period gets shorter because file size gets bigger. There are 4 steps quality such as Super, High, Medium and Low

To save the setting, choose 'Apply' after setting.

4) Event Recording

This is a window setting Event Record Mode. Setting method is same as Conti Recording method. Conti Recording and Event Recording can be operated simultaneously.

So during no event input, DVR records by Conti recording settings. However if there is an event, it starts recording by Event Recording settings during Time(sec). This function is very useful when you want to operate with the mixture mode.

- Duration(sec): to set post event recording time. You can choose between 1~60 seconds.

- Pre alarm(sec): to set pre event recording time. You can choose 1~4 seconds.

* Event recording has priority in recording. In C/E recording, the recording will follow conti recording setup in normal condition while it would follow event recording setup in event generation.

* For convenience, you can use the 'Apply All' menu to change with the same preference. You don't have to setup each channel if you using the 'Apply All' function.

[When Scheduler On]

If you select Schedule, following [Schedule Recording] setting window appears. If you choose Schedule On, the weekly scheduler is activated. Since you can set recording weekly, you can reduce recording of unnecessary time period. In Scheduler window, days and channels are displayed, and recording information for each channel is displayed at bottom of window.

<How to set the weekly scheduler>

1. Choose 'Scheduler' to 'On'.
2. Choose group and drag to wanted time.
3. Press the time bar if you want to set the detailed time.
4. Press 'Enter' button to change the group of the selected area.
5. If you activate 'Holiday' scheduler, choose 'holiday'.

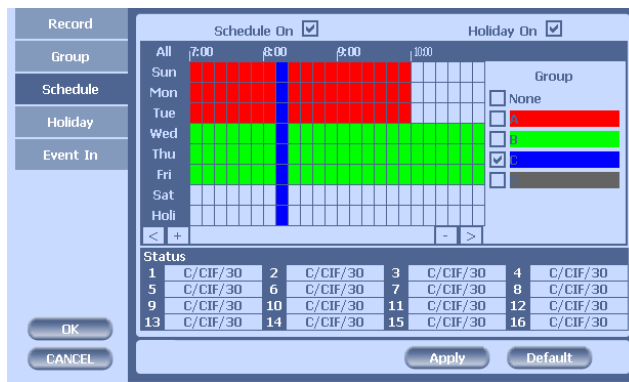
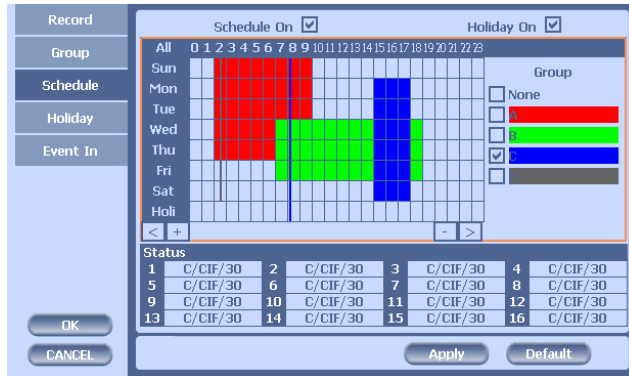

2) Group

With this menu, you can set the group using the scheduler. If you choose 'Group' tab, you can see the similar screen with 'Record'. The setting is similar.

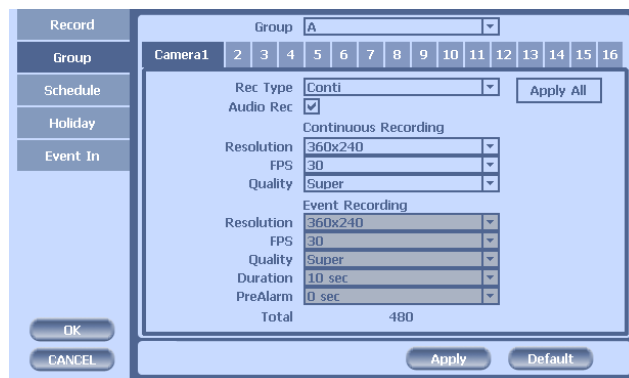

*In recording, Schedule recording setting is most preferred. So if you activate the weekly scheduler, you cannot record manually.

3) Holiday

With this menu, you can add the holidays. Use the 'Add' button for adding the holiday and use the 'Delete' or 'Delete All' buttons for removing the existing holidays.

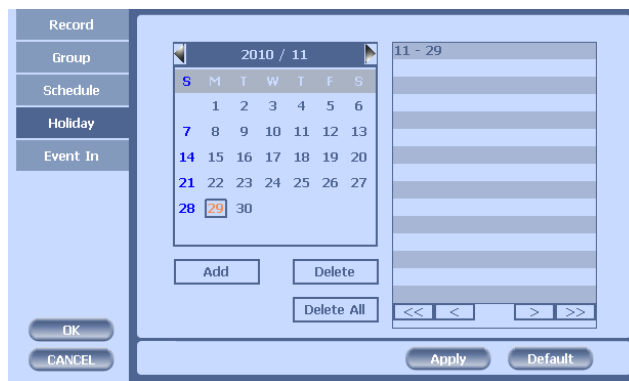

4) Event In

With this menu, you can set sensor input, motion detection setup. You can also set each channel individually. Each channel may be configured to M (Motion) / S (Sensor) / V (Both)

* Summary regarding as Event Recording

	Event Input	Motion Detection	Sensor Setting
MD recording	MD	ON	OFF
Sensor detection and recording	Sensor	OFF	ON
MD,Sensor detection and Recording	MD/Sensor	ON	ON
MD,Sensor Detection and non-recording	None	ON	ON

*In REC Menu, MD recording, Sensor detection recording, MD, Sensor detection recording and no recording are determined according to Event Input.

*Although you set Motion Detection and Sensor Setting to On in Event menu, if Event Input in Rec Menu is set to None, it only detects and does not record.



3-4-3. Device

Configure and view Camera, Private Zone, Audio, Motion Detection, Alarm Out, PTZ settings and Controller.

1) Camera

You may configure and/or view camera video type and general camera configuration.

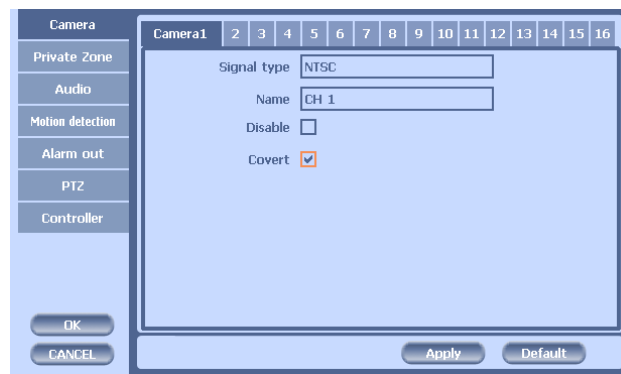

- Channel Name: You can set the camera name.
- Disable : Disable current camera. It is useful when the signal is bad.
- Covert : Hide current camera from Live view but Record for future searching option

2) Private Zone

If you want to hide some part of the picture for privacy, you can choose the area by dragging the mouse. The selected area will be changed to mosaic screen.



- ① All On : All area will be mosaic.
- ② All Off : .No mosaic
- ③ Apply all : apply the setting to whole channel

3) Audio

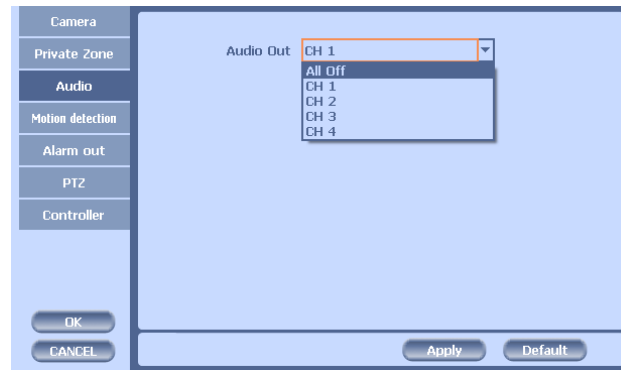

- Audio Out: Select which channel will be heard during Live View.

4) Motion Detection

Change settings for Motion Grid selection and Sensitivity Level. You can set multiple area.

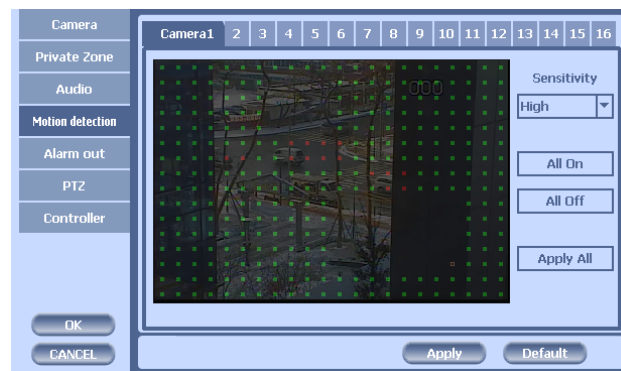

- ① Sensitivity.: 3 steps
- ② All On/Off : This will activate or deactivate the motion detection of the all area.
- ③ Apply all : apply the setting to whole channel

5) Alarm Out

There are 3 types trigger such as sensor input, motion detection and video loss. This setting is related that which trigger will be activate the action such as Relay, Popup, and Buzzer Alarm Out. Each type can have separate Duration value and also linked to selected camera.

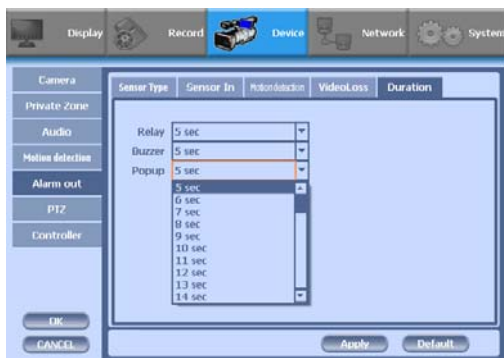
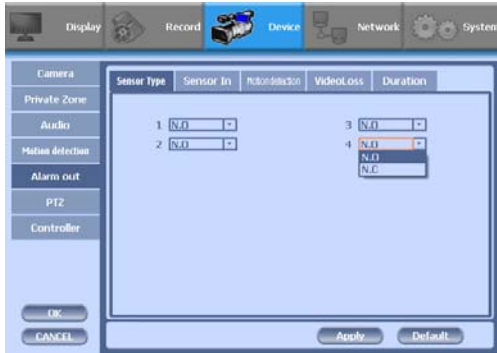

- Duration Time from 0 seconds to 999 seconds
- Sensor Type: Selectable option is N.O. (Normally Open) / N.C. (Normally Close)

6) PTZ

Configure Pan/Tilt/Zoom camera for control via DVR System and Remote client



Driver: Choose Driver to be suitable for PAN/TILT Camera manufacturer.
 You have to set Comport value according to the connected camera. There are more kinds of camera which can be supported. Please contact the tech support to want to know the other cameras.

	Baudrate
PELCO D type	9600~2400
PELCO P type	2400
PANASONIC	2400~19200
ORIENTAL	2400(Fixed)
LPT-A100L	9600(Fixed)
LG-SD110	2400~19200

* For connection of PAN/TILT Camera Receiver part, refer to user's manual of the related PAN/TILT Camera.

7) Controller

This sets the ID of remote control. If you have many DVRs in the same place, you can control separately the DVR by different remote control ID.
 Use the ID setup and number key to set the ID of remote control on the remote controller. You may check the ID by pressing the remote control key. The ID should be the same between the DVR and remote control.

3-4-4. NETWORK

Configure and view Address, Port, DDNS, E-mail, Control and Status settings

1) Address

Configure Network information for Remote client connection



- DVR Name : Type the URL of DVR using virtual keyboard.
- Type : It can be supported only Ethernet
- DHCP (Dynamic Host Configuration Protocol)
 - Set whether you want to use DHCP or not (On/Off)
 - If you connect LAN after setting it to On, IP is allocated automatically. If you set it to Off, you have to input IP. DHCP is a protocol that allows managers to manage and allocate IP address centrally.

2) Port

There are 4 kinds of ports for the case such as watch, search, setup and web. You can individually set the port number of the DVR. The default is 8000. You can choose from 8000 to 9999.

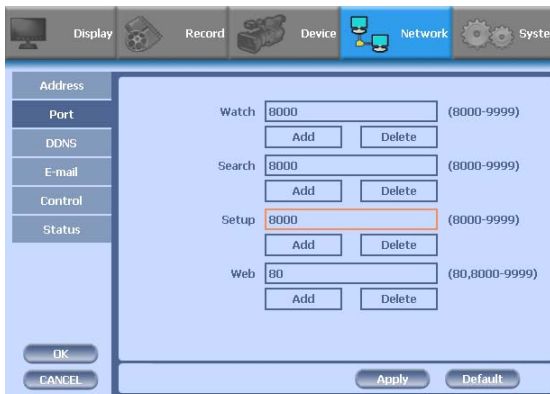

3) DDNS

This is the function to automatically change the IP of DVR to URL. This product supports the automatic DDNS service using manufacture's internal server. Also you can choose DynDNS.



4) E-mail

You can send the event by email. Fill all the information correctly and push the 'Email Test'. Also you can select each event individually by 'Event Set'.



5) Control

You can individually adjust the resolution and frame rates of video transmission within 120 frames.



- ① Resolution : You can choose CIF or QCIF
- ② FPS: You can adjust the frame rate.
- ③ Quality: Set picture quality

6) Status

This shows the information how many connections and what is the action of each connection.



- ① Connected IP : This displays all the connected IP.
- ② Watch User: This displays how many connection for live viewing.
- ③ Search User: This displays how many connection for playback.
- ④ Setup User: This displays how many connection for DVR setting.

3-4-5. SYSTEM

Configure and view system Date/Time, User Authority, Storage, System Log and Configuration settings

1) Date/Time



- Time Zone: Choose the time zone of your site. If you using the NTP function, it must be set correctly to your zone.
- Daylight Saving Time: It enables to adapt the day light saving time automatically.
- Date/Time: This sets product time. Input time by pressing number buttons after moving cursor with direction buttons. Be careful to move to backward. The overlapped data will be deleted with warning message.
- NTP (Network Time Protocol) Server: This function is to change the time of DVR automatically via network. Press the 'Enter' button and using the virtual keyboard, type the address of NTP server.

2) User Authority

This sets User authority individually. You can give to each users the authorities such as setup, search, backup, PTZ, network and camera control.



3) Storage



- Display the information and usage of the hard disk drives. If you press the 'Format' button on each HDD, only that HDD will be formatted.
- Total : Display all the HDD usage being used for the product. If you press the 'Enter' button on here, all the hard disk drives will be formatted.
- HDD Overwrite : Determine whether you want to continue recording if there is no spare saving space at hard disk drives.

Mirroring : If you install two hard disk drives, you can set the second drive as a backup drive by mirroring. The mirrored disk size will be the same or greater than master HDD.

- Auto Deletion : You can select the holding period of the data. If you choose 'OFF', the DVR keep the maximum data regarding the HDD capacity.

4) S.M.A.R.T (Self-Monitoring Analysis and Reporting Technology)

This function lets you probe the hard disk drives and investigate the status of the drivers automatically.

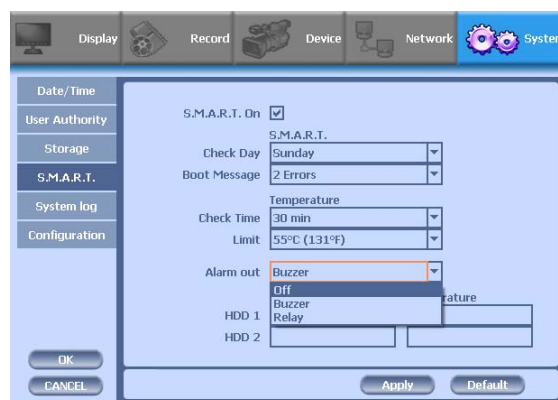

- Check day : Determine the date to perform the SMART.
- Boot message : the number of message of showing the errors
- Check Time : Temperature check period
- Limit : The upper tolerance of the hard disk drive temperature
- Alarm out : You can choose Buzzer or Relay

5) System Log

You may view all System administration log from Setup → System → System Log. Also you can export the system log and easily send it to technical support for trouble shooting.

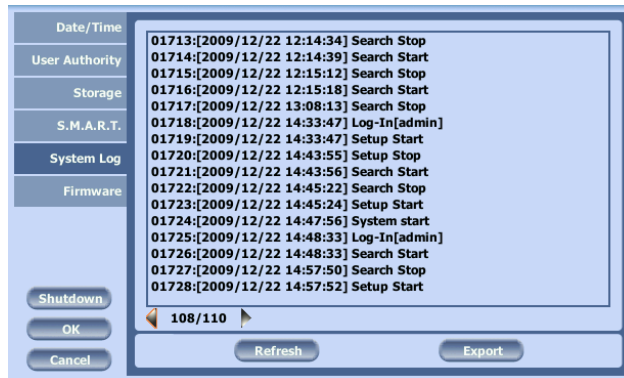

6) Configuration

Shown at the following screen, from Setup → System → Firmware, you may view the current firmware version as well as Upgrade the firmware and additionally, Export, Import, and Default DVR Configuration.

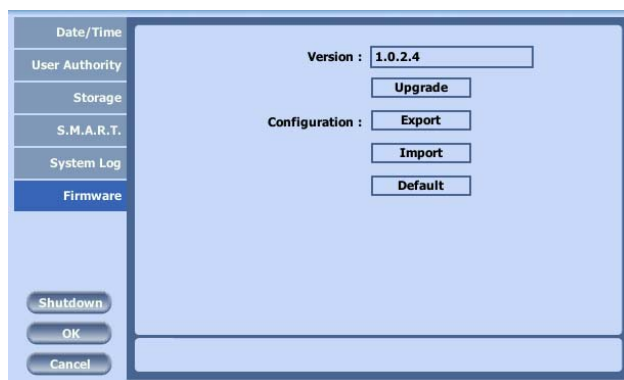

CH4. Client Program

4-1. Installing Client Program

This program supports Windows 98, 2000, ME, XP and Vista.

This program installation is for communication between DVR and PC.

Execute SETUP.EXE on CD provided with the product.

When you followed installation procedure properly and Active DVR 104V folder is created on program menu, program installation process is completed.

You can play Live image of DVR and search files recorded on DVR by connecting DVR and PC with LAN through Client Program. Moreover, you can upgrade S/W of DVR with Firmware provided with the product and save still image on PC in Search Mode of DVR.

CPU and VGA are absolutely effective for playing recorded file and recording performance. Since VGA is effective for several areas including errors and performances in regard to operation characteristics, you have to use verified products. If not you may experience not being able to see images or low screen quality while playing.

※ This client S/W sends and receives the huge amount of data. So it will be recommended not to execute with the other application program. Failure may be happen at that case. Especially vaccine program may make a trouble on live and playback.

▶ Recommended Client PC Specification

- CPU : Pentium IV 3.0GHz or higher
- RAM : 1GB or higher
- VGA : Memory 256MB or higher
- LAN : In 10/100 network environment, 100Mbps or higher environment
- DirectX9.0 or higher,

▶ Minimum Client PC Specification

- CPU : Pentium IV 2.0GHz or higher
- RAM : 512MB or higher
- VGA : Memory 64MB or higher
- LAN : In 10/100 network environment, 100Mbps or higher environment
- DirectX9.0 or higher,

In the case of the 'Favorite mode', more the number of connected channel will increase the CPU occupancy. So the maximum number of connected channel is dependent on your PC computing power.

► Available VGA

- Chipset from nVIDIA: GeForce 4- Higher than 64MB
- Chipset from ATI: Radeon - Higher than 64MB
- Chipset from MATROX: G450 - Higher than 64MB
- Chipset from Intel: Higher than 64MB

If you use a chipsets with lower specifications compared to the above benders, there might be program errors or low screen quality like black&white screen or you will even be unable to play.

You can only play with high color(16 bit) or higher, and you will not be able to play properly with 256 colors.

- ① Open CD-ROM Drive and Run Setup.exe and then Appear Setup Menu.



- ② Click 'Next'.

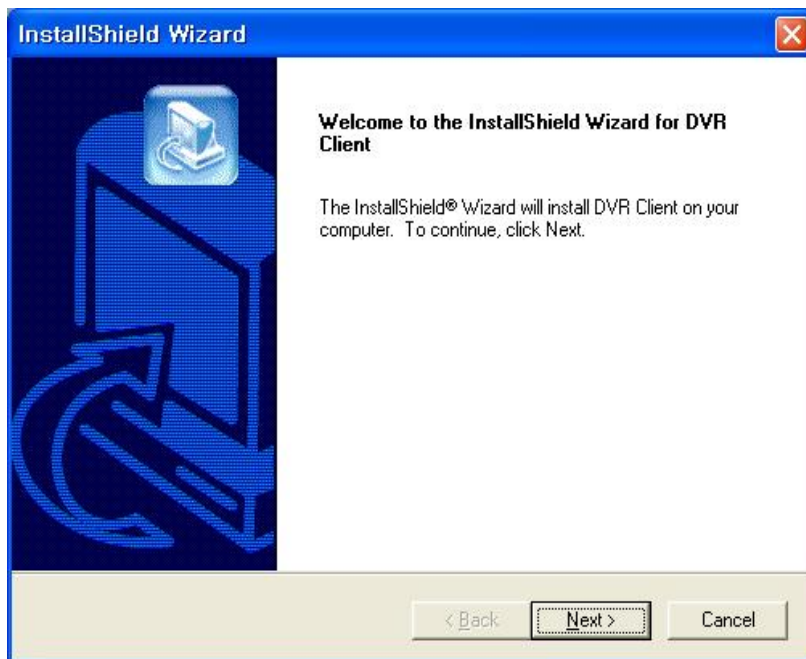

- ③ Ask designate Folder to Install the program
Recommend Basic setup c:\program files\Digital Video Recorder \DVR client
Click Next.



- ④ Showing Progress of Copy of Files.

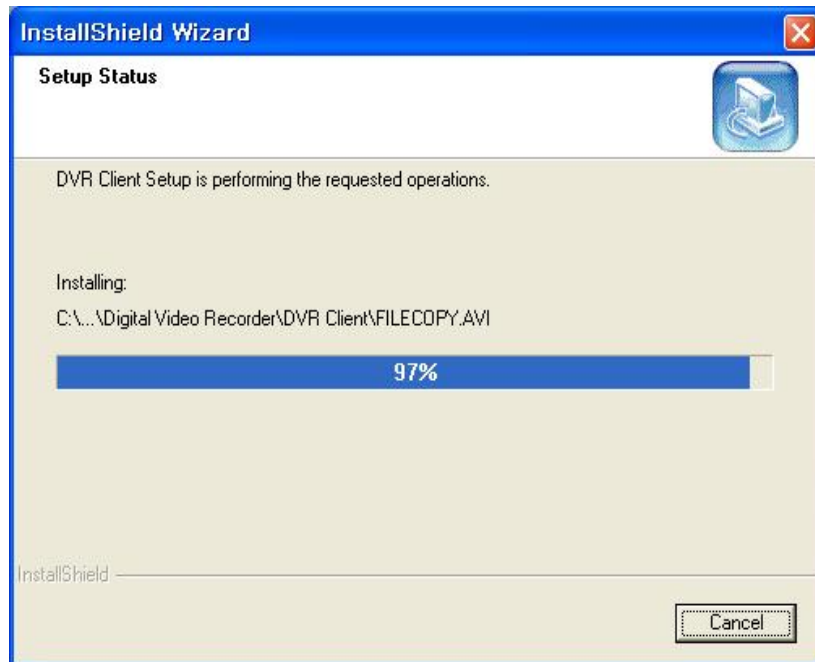

- ⑤ Click 'Next'

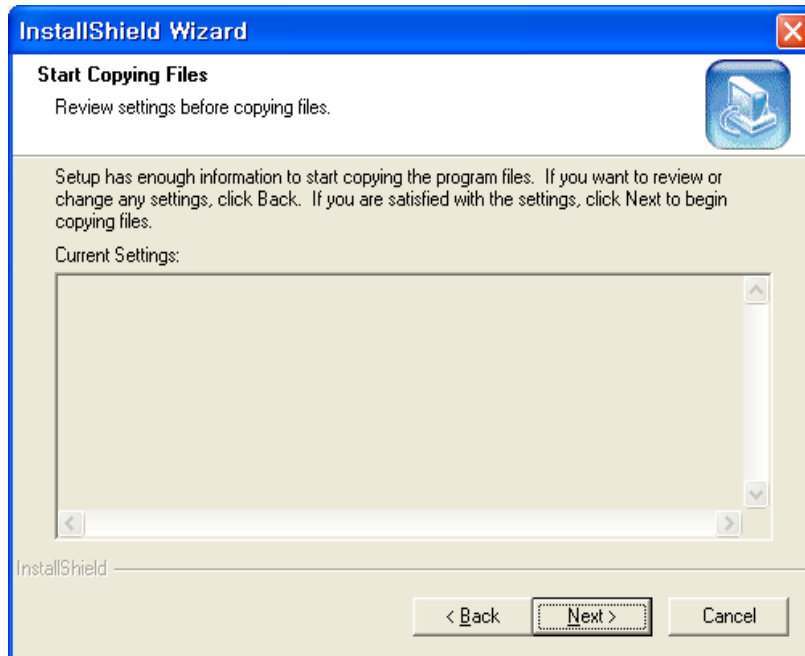

- ⑥ When Finishing Installation, click 'Finish'.



- ⑦ Finish Program Installation

4-2. How to Use Client Program

If you execute Client Program, you will see following password screen.
 After entering the right password (**default is none**), you can do remotely seeing Live Image on DVR through Client Program, and you can do searching, playback and setup the DVR.

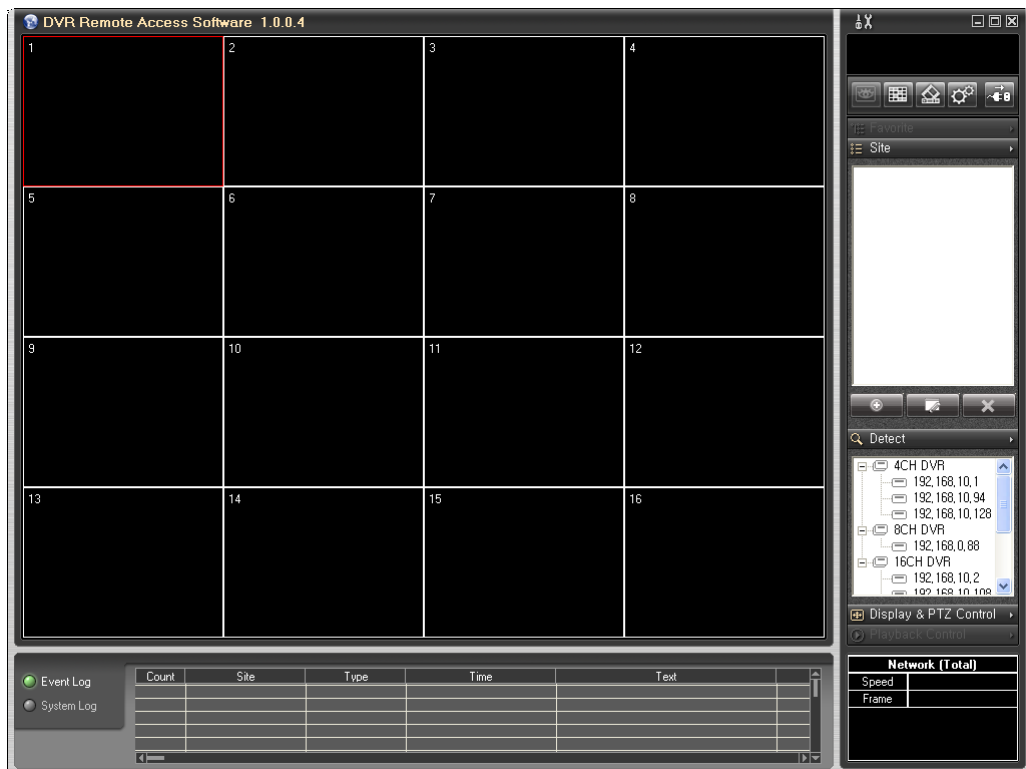

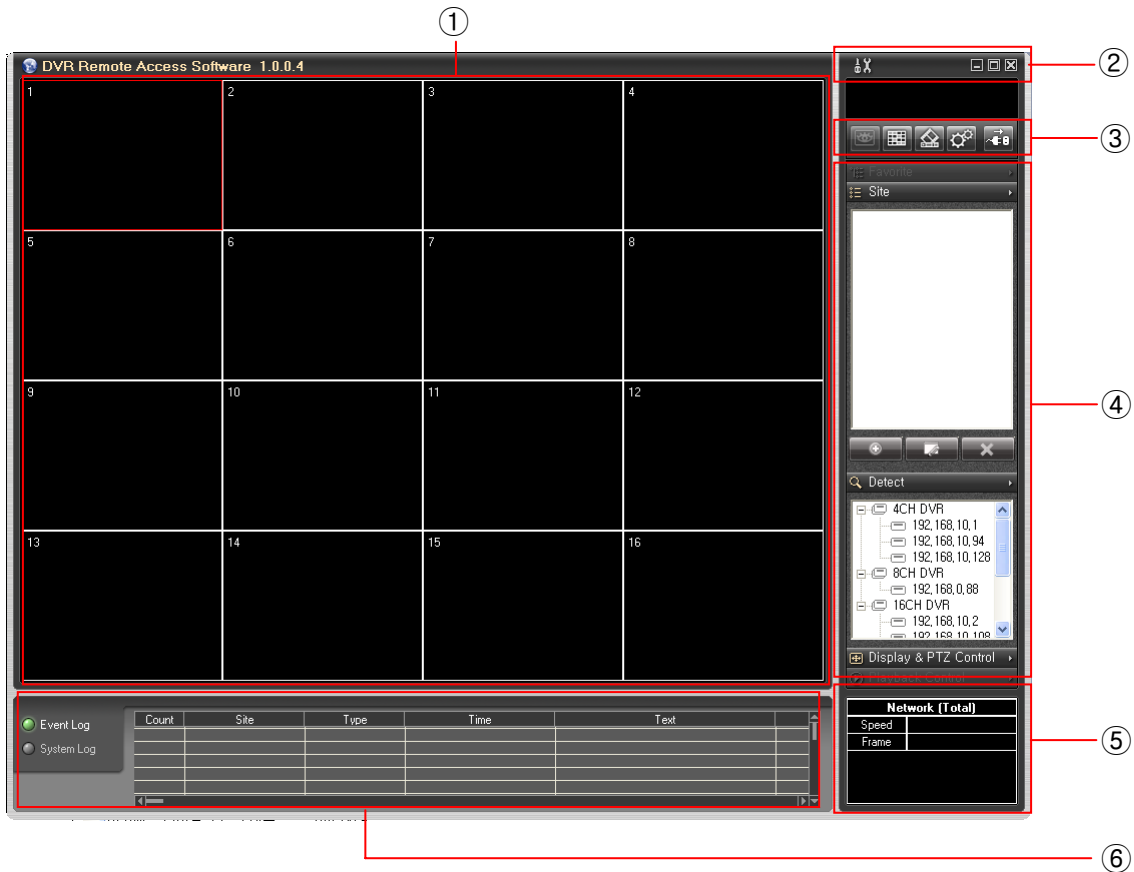

4-2-1. Initial Screen





① Display screen shows the live and playback images.

②  Setting : To go to the setup screen

 Minimize : To minimize the client software window

 Maximize : To maximize the picture. You can use the full monitor screen to see the picture. If you want to back to main screen, use the 'ESC' or mouse right button.

 Exit : To quit the client software

If you press the 'Setting()' button, the below screen appears.

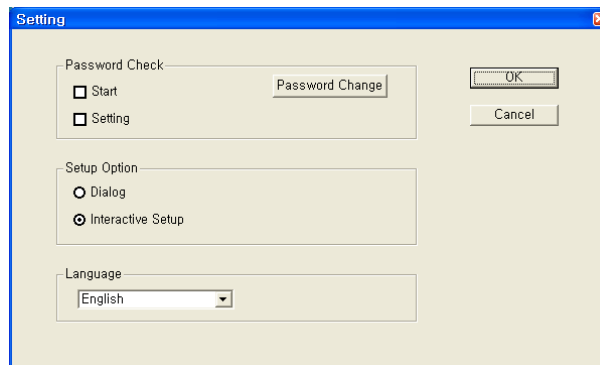

Client software password setup : the setting about password

Start – If choosing, it will ask the password on starting.





Setting – If choosing, it will ask the password in order to enter the setting

Password Change – Changing the password

Setup Option : Choosing the remote setup method

Dialog – If you choose the 'Dialog', You can set the DVR using dialog windows. If you don't want to show the changing the setup on local DVR, use this feature.

Language – Choosing the language of remote software

- ③  WATCH MODE : Live screen.
-  FAVORITE MODE : To connect the multiple DVR and to show the multiple channel up to 64
-  SEARCH MODE : Playback Screen
-  SETUP MODE : Setup of connected DVR
-  CONNECT : To connect or disconnect the selected DVR.



Favorite : You can connect multi-DVR using this. You can also make a list of IP Addresses you frequently use for your convenient use.

Site : This shows the DVR list which you want connect.



Add : You can add new IP Address.



Edit : You can edit IP Addresses and other connection information on the list.



Delete : You can remove saved list.

Detect : Upon selecting this, all the DVR which connect to your LAN display on the box.

Display & PTZ Control : This changes to control window after connecting.

⑤

Network (Total)	
Speed	
Frame	

This shows the network speed and frame rates per channel.

- Site mode – It is possible to send up to 7.5 frames per second on 16 channel screen in Watch mode and 30 frames per second on 1channel screen.
- Favorite mode – It is possible to send 30 frames per second in each channel. However it is dependent on the network speed and PC computing power.

⑥ If you choose 'EVENT', all event will be displayed. If you choose 'SYSTEM', only the event regarding system will be displayed.

EVENT Log : motion detection, sensor, text in etc.

SYSTEM Log : DVR time change, DVR Power Off etc.

4-2-2. Connecting the DVR

If you click 'Add' button at lower right corner of initial screen , you will see 'Site Add' window. You can add the wanted DVR in this window.

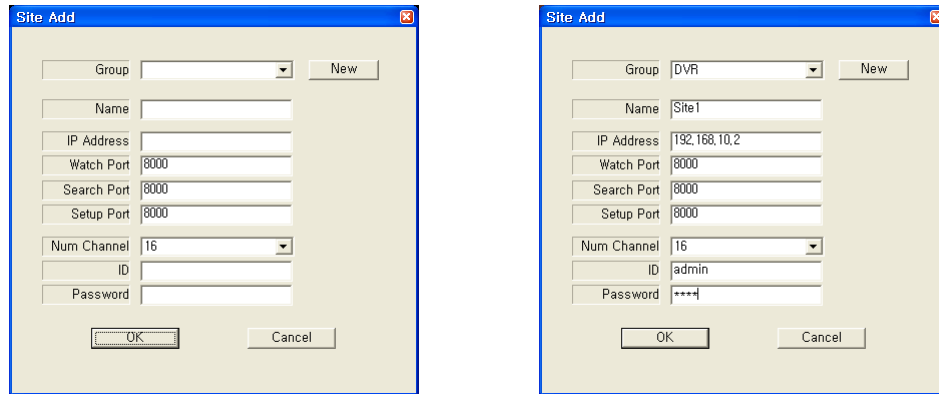

Group – You can set the group of DVR. You can choose the existing group or make the new DVR Group with 'New' button.

Name – You can set the name of the DVR.

IP Address - You can set the IP address of DVR.

Port – You can set the port number of DVR.

Num Channel – You should choose the number of exact DVR channels what you want to register.

ID – Please type the admin or user.

Password – Type the password of DVR.

After entering all the field, click the 'OK'. The DVR list will be added on 'Site'.

Another way to add the DVR is to use the 'Detect' function. In 'Detect' window, it shows all the DVR which is connecting in the same network. Choose any IP and click the 'add' button to add the DVR to your 'Site' list.



4-2-3. Initial Screen after connection

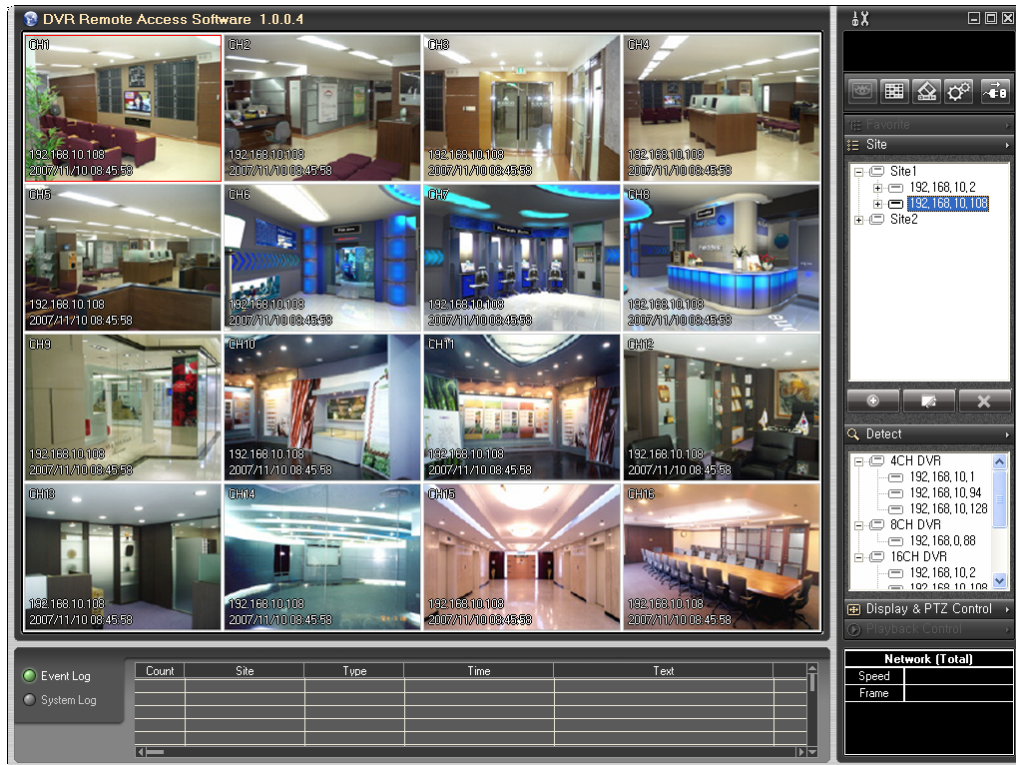

Choose the DVR on the 'Site' list and click the 'Connect' button. You can see the live screen of the selected DVR.

If you choose 'Favorite' button, you can connect many DVR at the same time and also you can make your own favorite DVR group.

4-2-4. WATCH – Live viewing

If you choose ‘Control’ button after connection, you can see the control screen.

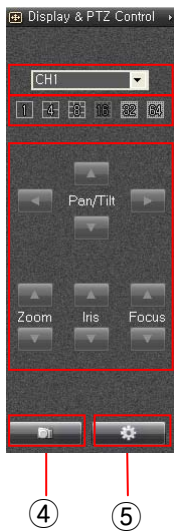

- ① Channel selection
- ② Display mode selection
- ③ PTZ control : You can control the PTZ camera .
- ④ Snap Shot : Used for getting snap shot. You can save with JPG or BMP. Refer to 5-2-6.
- ⑤ Option : Changing the related setting. You can see the dialog box below.

OSD Option : This turns the OSD On/Off on live viewing.

Favorite Mode Max Fps : You can adjust the maximum frame rate individually upon ‘Favorite’ connection. If you choose ‘AUTO’, the program chooses the optimum rates based on the PC and network speed.

Search Option : Changing the search option

Deinterlacer : It will remove the tail when you play with the D1(720X480 or 720X576) resolution and low frame rate (below 5 frames per second).

Skip P Frame : If you check this box on the case of using the narrow bandwidth network such as PSTN, it makes it possible to real time playback by skipping the P frame.

Audio : This turns the sound on/off.

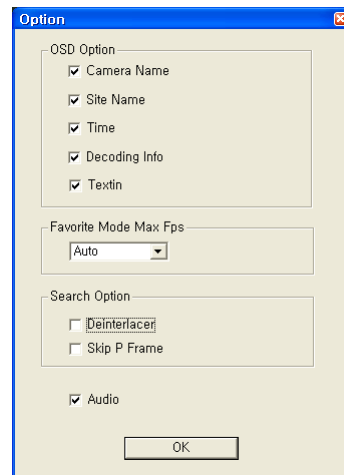

4-2-5. Favorite – multiple DVR connection

In Favorite Mode, you can make your favorite multiple connection lists by pressing the ‘Add’ button or dragging from the ‘Site’ lists.

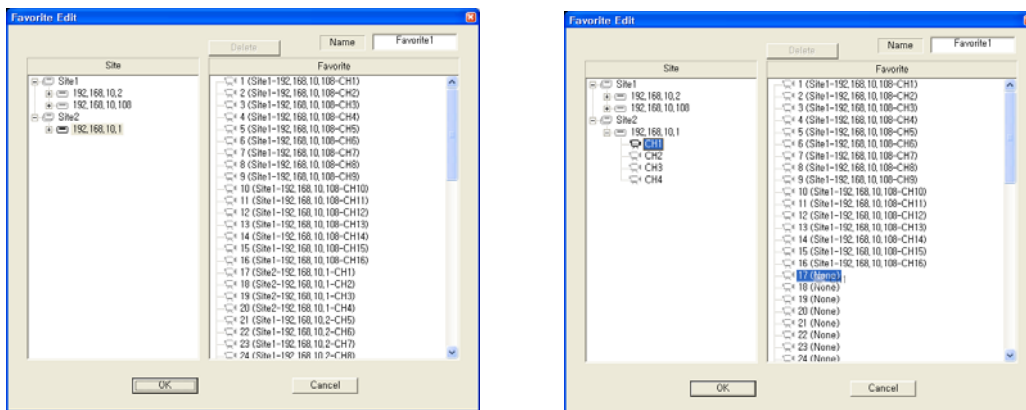

If you press the ‘Add’ button in Favorite Mode, the upper window will appear. The left side of the window shows the DVR list what you registered in site menu and the right side of the window shows the Favorite list which you want to edit. If you want to make the Favorite list, drag and drop the wanted DVR from the left list to the right channel number and the selected DVR will be registered to the Favorite list. And also you can register the individual channel not the whole DVR. After making the Favorite list, set the list name and press the ‘OK’ button to save the list.

If you press the connect button after selecting the Favorite list, the below window appears and you can watch simultaneously up to 64 channels. This favorite mode only can be adapted to the 'Watch' mode not a 'Search' mode and 'Setup' mode.



You can register the DVR or individual channel to the Favorite list directly not to make the list. You can just drag and drop the wanted DVR or channel from the right window to the wanted left channel. It will automatically connect to the selected DVR or channel.

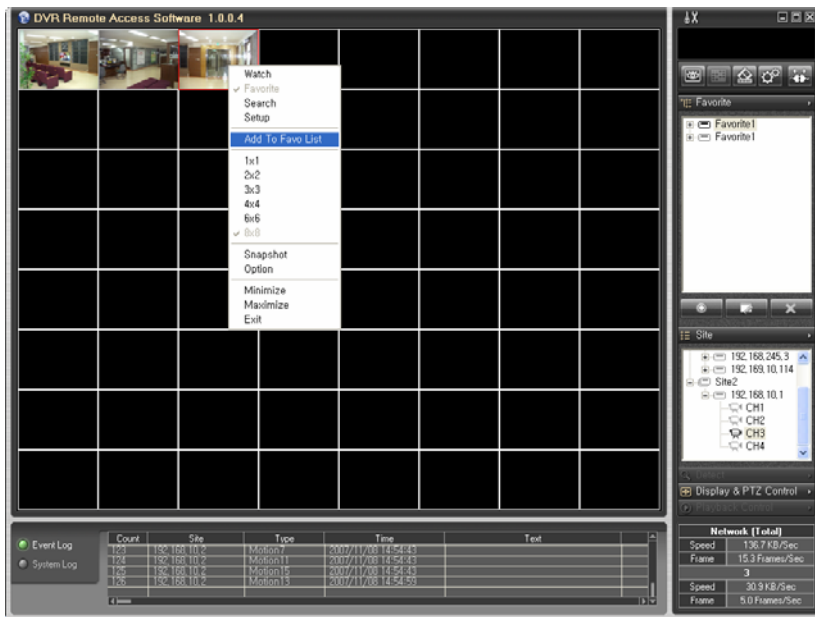

If you click the mouse right button from the upper screen and select the 'Add To Favo List', the favorite editing window appears and you can add the new connection to the list.

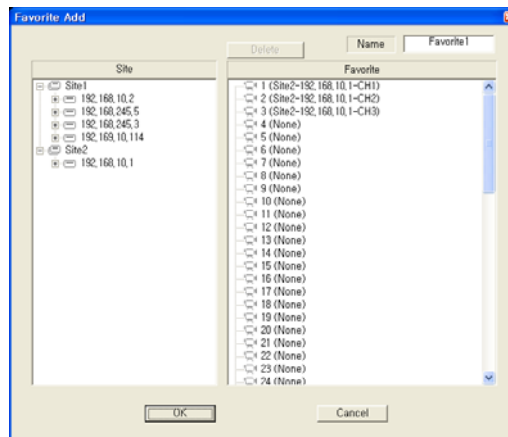





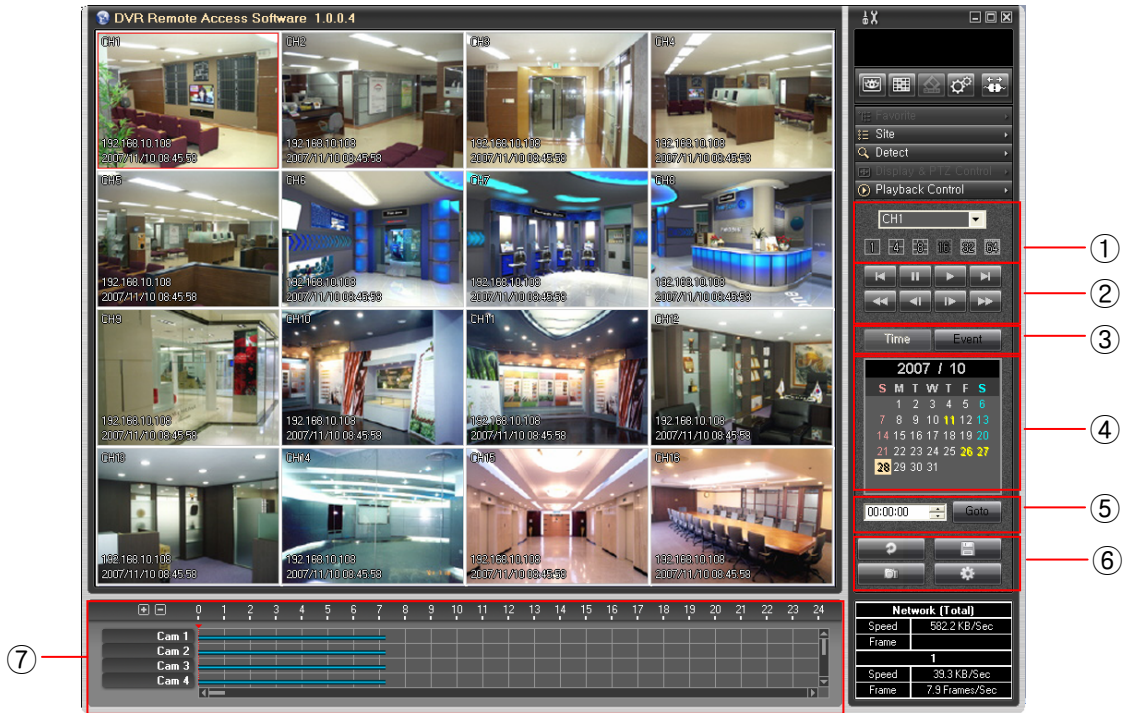



4-2-6. SEARCH – Playback



If you choose ‘SEARCH’ button after connection, you can go to the playback mode.
 If you choose ‘Control’ button on ‘SEARCH’, you can see the below control.



- ① Channel and display mode selection
- ② Play speed control buttons

-  Fast backward.(1,2,4,8,16,32,64 times faster).
-  Pause playback
-  Fast forward.(1,2,4,8,16,32,64 times faster).
-  Normal playback.

-  To play slowly forward.(1/2,1/4 times slower)
-  To play slowly backward.(1/2,1/4 times slower)
-  To go to the next image
-  To go to the previous image

- ③ Time : You can search by hour.
Event : You can search the event file from event list.
- ④ Calendar : You can select the date directly. When you choose the date, all the list display in ⑦ window. If you choose 'EVENT', you can search the event ((Sensor Input, Motion Detection etc.).
- ⑤ Time Search : To go to the specific time directly using this feature
- ⑥  Update all the information.
-  Saving with AVI format into the PC

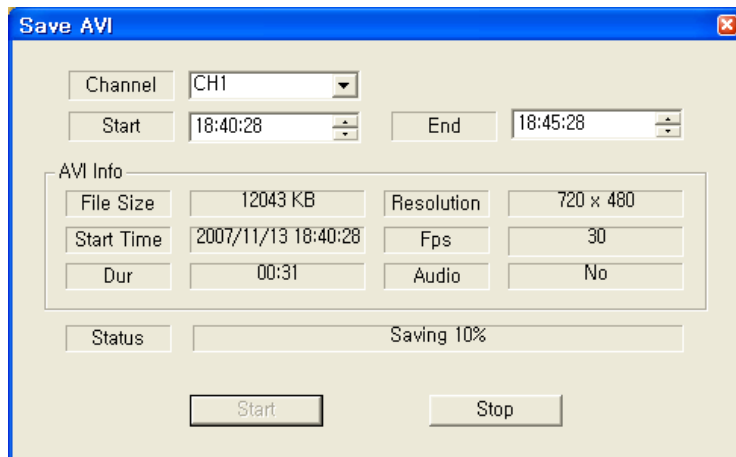

Enter the Start and End time. And press the 'Start'. It will start to send the file to the PC and all the information of file will be displayed. After sending the file, choose the filename and folder.



Snapshot : This is the feature to capture the image in LIVE or PLAYBACK as well as saving and printing it. If you press this button, following Image window will be appeared.

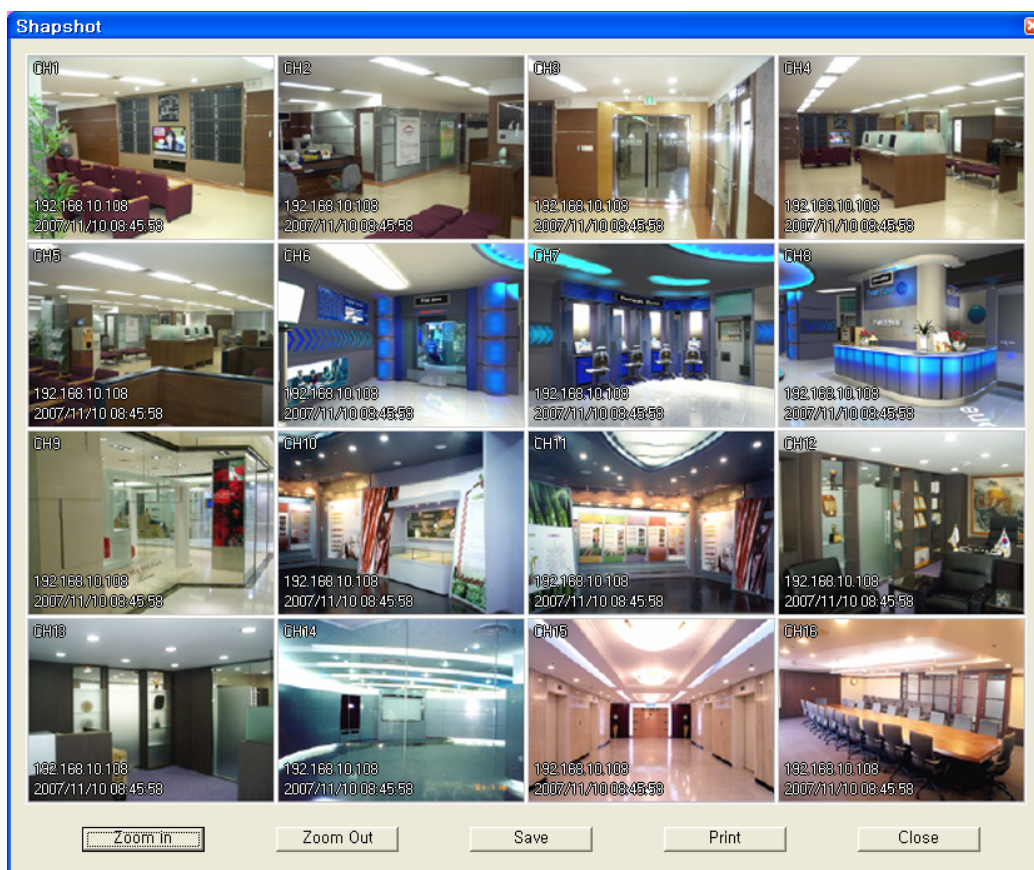

Zoom In : You can enlarge the image, every time you click the button, it will enlarge the picture up to 4 times. (Click and hold left the mouse button in order to move the image around.)

Zoom Out : Reduce enlarged screen, every time you click, it is reduced by 1/2.

Save Image : Save image as picture file. If you select where you want to save it and input file name and press Save Button, file is created. (you can save it as bmp or jpg file.)

Print Image : Print out still image through printer. You can print out the screen by selecting printer and pressing Print Button.

Close : Close Image Dialog window.



Option : Changing the related setting.

OSD Option : This turns the OSD On/Off on live viewing.

Favorite Mode Max Fps : You can adjust the maximum frame rate individually upon 'Favorite' connection. If you choose 'AUTO', the program chooses the optimum rates based on the PC and network speed.

Search Option : Changing the search option

Deinterlacer : It will remove the tail when you play with the D1(720X480 or 720X576) resolution and low frame rate (below 5 frames per second).

Skip P Frame : If you check this box on the case of using the narrow bandwidth network such as PSTN, it makes it possible to real time playback by skipping the P frame.

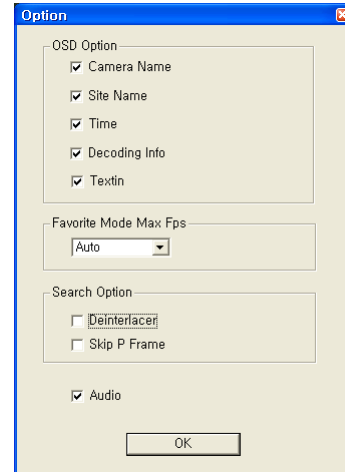

Audio : This turns the sound on/off.

⑦ This displays the recorded file by graphic bar. You can playback directly just one click with mouse on the recording bar . Blue color means the normal recording file and Red color means the event recording.

If you select 'EVENT' on ③, the following event list appears. You can play by choosing the wanted event.

Count	Site	Type	Time	Text
1	Site1	Motion7	2007/10/27 00:00 09 (00:04)	
2	Site1	Motion11	2007/10/27 00:00 09 (00:04)	
3	Site1	Motion13	2007/10/27 00:00 09 (00:04)	
4	Site1	Motion7	2007/10/27 00:00 13 (00:18)	
5	Site1	Motion11	2007/10/27 00:00 13 (00:28)	

On the screen, if you click the mouse left button, that channel will be full screen mode. If you want to go back the previous screen, click the mouse left button twice.

4-2-7. SETUP – Remote setup of DVR

You can change the preferences of the DVR remotely. Click the ‘SETUP’ button to set up the DVR remotely and setup screen will appear. You can see the same GUI of the DVR. Therefore, you are able to set as like as in front of the DVR.

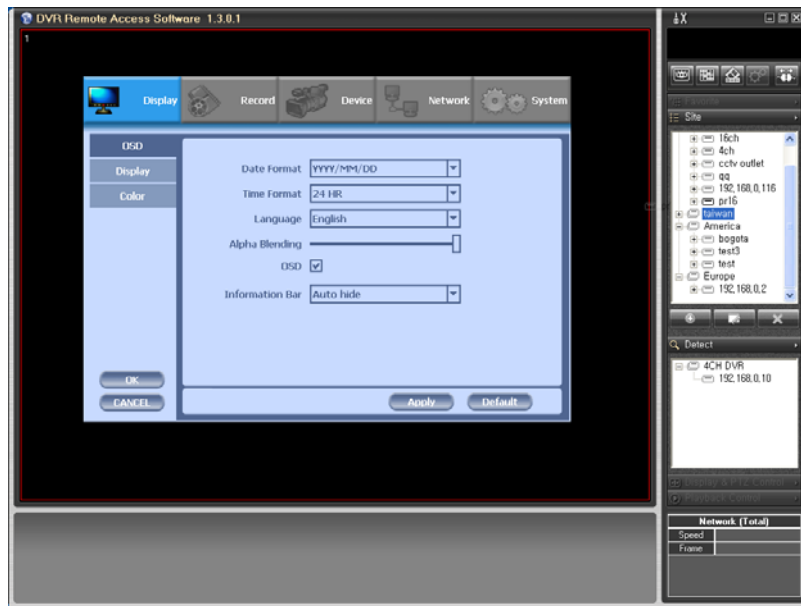

4-3. Firmware Upgrade

After installing the client software, you can find the 'NetDownloader Program' in the window programs (Start -> programs -> DVR Client -> NetDownLoader) . Please execute this 'Net Downloader Program' to upgrade the firmware of the DVR.

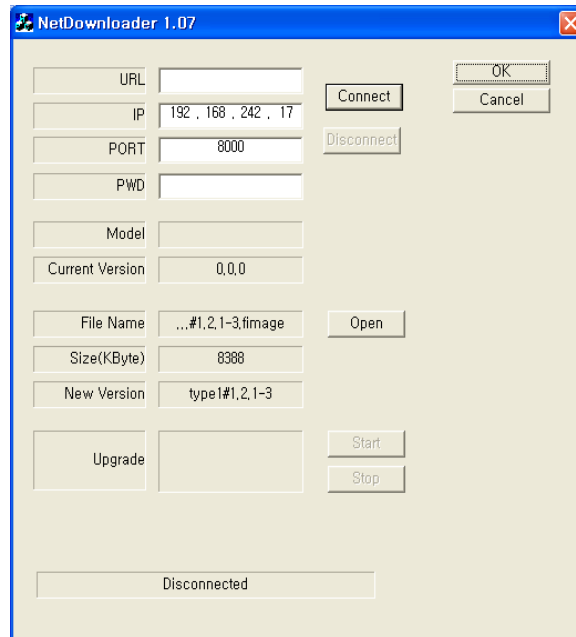

After typing the IP and password of the DVR, click the 'Connect' button. You can check the model name and the current version. If you can't see the model name and current version, you should check the network and try again.

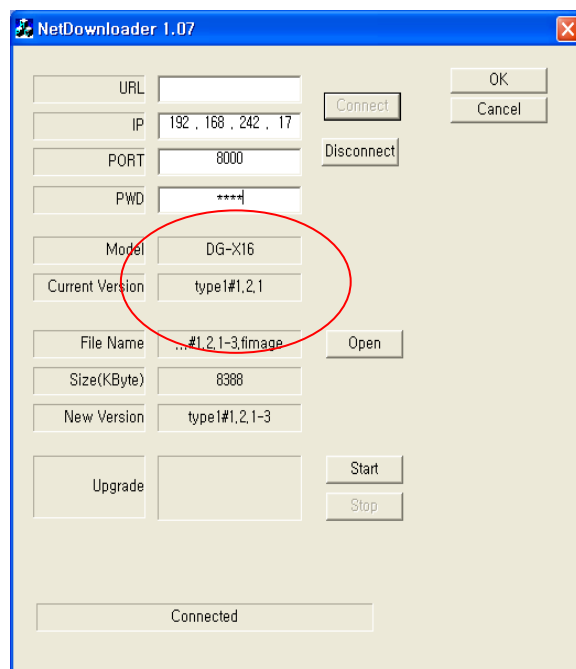

When you connect the DVR, click the 'open' button on the 'NetDownloader Program' and select the update file and then press the 'start' button. You can see the below download window on the DVR screen.

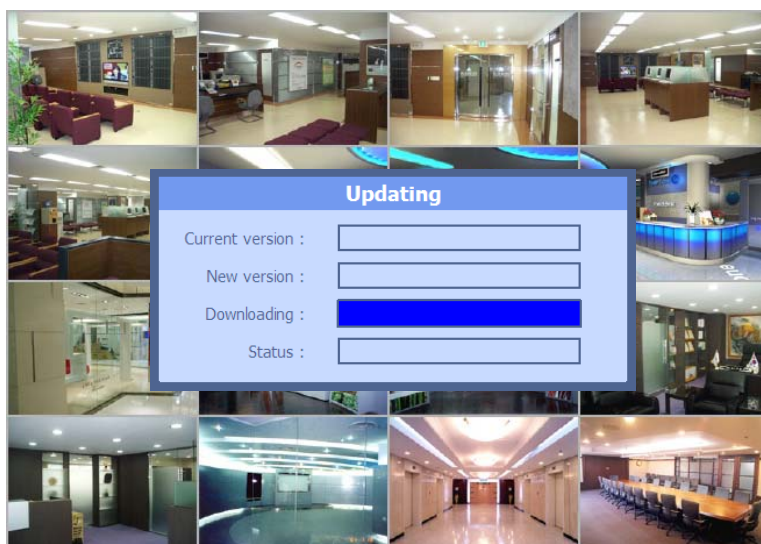

 **WARNING!!!**

Do not turn off the power during download procedure. If you power off manually, all memory will be deleted !

※ After upgrading, DVR will reboot automatically. Before rebooting, do not operate manually !

4-4. Web browser Monitoring and Playback

This DVR has built in web server. You can monitor and control the PTZ camera using the web browser. Type the IP or domain address to connect the DVR. Then type the USER ID (admin or user) and the password of the DVR. You can see the live picture to click the 'connect' button.

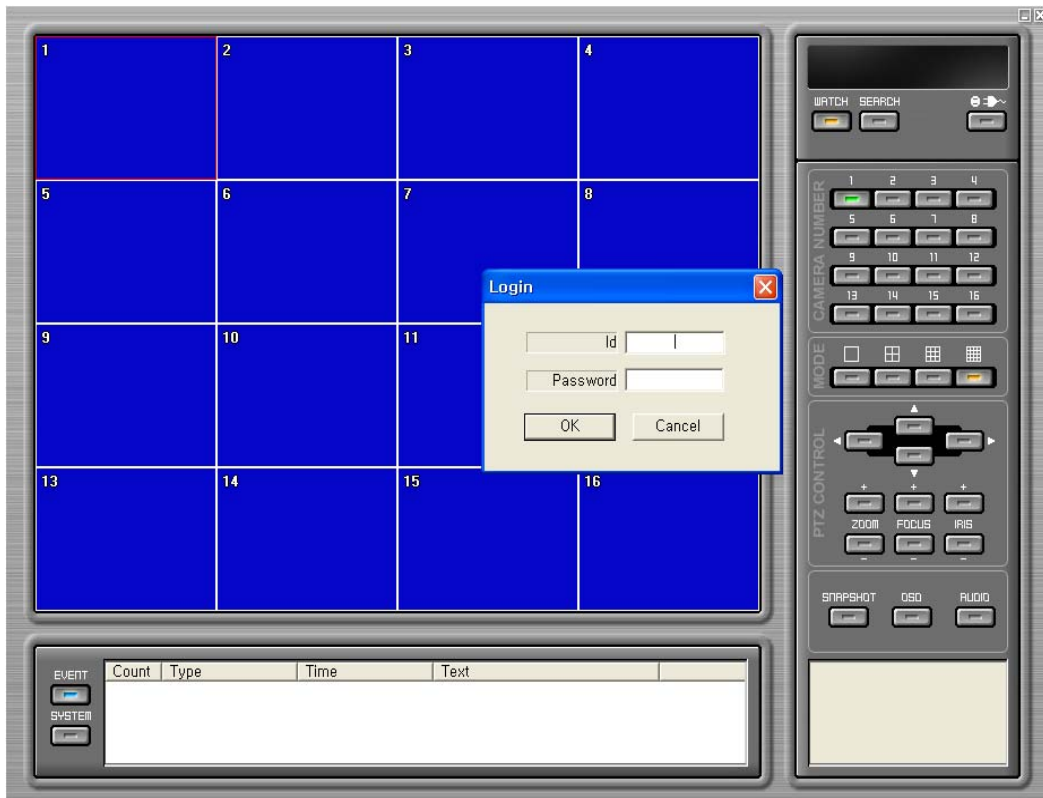

After typing the ID and password, press the 'connect' button, then you can see the live screen.

You can use all the same function with client software except 'Setup'. Refer to the 5-2 and 5-3 .

Trouble Shooting

Symptom	Checkpoint	Countermeasure
<ul style="list-style-type: none"> ● Can't turn on power ● There is no image on monitor ● Only INFO OSD is on monitor and no image ● There is Video Loss message. ● Can't search with Client Program. ● Motion Detection doesn't work well ● There are differences between Live screen and actual condition during remote monitoring ● Live doesn't work well in remote monitoring 	<ul style="list-style-type: none"> ● Is DVR connected to power supply cable? ● Are DVR and monitor turned on? ● Are cables of DVR connected?. ● Is camera turned on? ● Are cables of DVR and monitor connected? ● Is NTSC/PAL setting normal? ● Is connection between DVR and camera normal? ● Isn't another user using same IP? ● Isn't it too bright or too dark? ● Isn't camera installed too far away? ● Is it set to True Color? ● Are PC specifications and VGA Card specifications are appropriate? 	<ul style="list-style-type: none"> ● Connect power cable ● Turn on power. ● Connect DVR cable. ● Turn on camera. ● Connect cables of DVR and monitor. ● Check whether NTSC/PAL setting is SETUP properly ● Check whether DVR and camera are connected properly ● Use it after another use finishes using it. If another user is searching DVR remotely with same IP, you can not search. ● Increase Motion Detection sensitivity. ● Install camera closer. ● Since it buffers Live images, there might be changes with actual condition. (1~2 sec) ● Refer to recommended Client PC specifications in 4-1 Installing Client Program?

Warranty

This product guarantees free repair based on guarantee regulations only if the malfunction is caused while customers were using it properly.

Warranty Period

Warranty period begins from the day this product is delivered to customer.

Model Name		
Warranty Period	From . . . To . . . (for year)	
User	Address :	
	Company :	
	NAME :	TEL :
Retailer	Address :	
	Company :	
	NAME :	TEL :

In case the malfunction is caused by one of following reasons, repair shall be provided as charged service.

- A) If cause for the malfunction is from external condition other than the product
 - B) If malfunction is caused because user tried to reassemble the product
 - C) If malfunction is caused by natural disasters such as fire, water disaster, thunder and others
 - D) If malfunction is caused while transporting or moving the product after purchasing
1. All other refunds other than warranty repair for this product shall be based on actual cost.
 2. Refund standard about product repair, exchange or repayment observe Regulations for Compensating Customers' Damage provided by the Economic Planning Board.
 3. Repair part providing period is for five years from the day the production for this product stops.

	Address	
	Tel	
	Fax	
	URL	