

4Ch H.264 Hardware Codec
H.264 Network DVR

User's Manual **VER 1.0**



4 Channel Network DVR
Real-time playback / USB backup

The most stable and reliable real stand alone Digital Video Multiplex Recorder

INSTALLATION & SAFEGUARDS

All the safety and operating instructions should be read before the unit is operated.

Environment Condition for Installation

1. To prevent electric shock or other hazard, do not expose units to rain, moisture, or dust.
2. Place this unit in a well-ventilated place and do not place heat-generating objects on this unit.
3. This unit should not be located in an area where it is likely to be subjected to mechanical shocks.

Before You Start



1. Ensure the power switch is in the OFF position prior to starting.
2. Do not attempt to open or remove the covers. That may expose you to dangerous voltage or other hazards.
3. Installation should be performed by qualified service personnel only.
4. This unit should be operated only from the type of power source indicated on the manufacturer's label and with the power supply included with the unit.

Notice



1. Before initial configuration or operation you must first set the TIME/DATE, followed by HDD clear. If you don't follow this steps first, that may cause non recording on the HDD or non saving setting value. Even though it is recorded, you cannot search recorded data.
2. When it comes to HDD capacity, you can use a big size of HDD.
3. When you set the record setup, you have to set the Record Configuration and also Schedule Setup. This unit records as per the Record type & Schedule setup. The default setting value for Schedule setup is Continuous mode.

Notice



This equipment has been tested and found to comply with the limits for a Class A digital device, pursuant to part 15 of the FCC Rules. These limits are designed to provide reasonable protection against harmful interference when the equipment is operated in a commercial environment. This equipment generates, uses, and can radiate radio frequency energy and, if not installed and used in accordance with the instruction manual, may cause harmful interference to radio communications. Operation of this equipment in a residential area may cause harmful interference in which case the manufacturer of the device is not responsible and the user would be responsible to correct the interference.

Contents

CHAP. 1	Features & Package Contents	-----	4
1-1.	Features	-----	4
1-2.	Package Contents	-----	5
CHAP. 2	Function of Each Button	-----	6
2-1.	Front	-----	6
2-2.	Rear	-----	7
CHAP. 3	Installation	-----	8
3-1.	Installation	-----	8
1)	HDD (Hard Disk Drive)	-----	9
2)	Camera	-----	9
3)	Monitor	-----	10
4)	Power	-----	10
5)	Other External Device	-----	11
CHAP. 4	Operation	-----	12
4-1.	System Log In	-----	12
4-2.	HDD Clear & Factory Default	-----	12
4-3.	Display Configuration	-----	15
4-4.	Live View Setup	-----	16
1)	Full / Multiple View	-----	16
2)	SEQ	-----	16
3)	PIP View	-----	16
4)	ZOOM View	-----	16
5)	Freeze	-----	16
4-5.	Record	-----	17
4-6.	Playback	-----	17
4-7.	Search	-----	18
4-8.	PTZ Camera Operation	-----	19
4-9.	Data Backup	-----	19
CHAP. 5	Setup	-----	21
5-1.	General Operation	-----	21
5-2.	Display Setup	-----	22
1)	VGA Setup	-----	22
2)	Screen Display Setup	-----	23
3)	OSD Setup	-----	23

Contents

5-3.	Record	-----	24
1)	Record Setup	-----	24
2)	Schedule Setup	-----	25
5-4.	Configuration	-----	26
1)	HDD Management	-----	26
2)	Time/Date Setup	-----	27
3)	Camera Setup	-----	27
4)	Motion Setup	-----	28
5)	Interval Setup	-----	29
6)	Alarm Setup	-----	29
7)	Password Setup	-----	29
8)	Buzzer Setup	-----	30
5-5.	External Device Setup	-----	30
1)	TCP/IP Setup	-----	30
2)	Pan / Tilt Setup	-----	39
3)	Audio Setup	-----	39
4)	Spot Setup	-----	39
5-6.	Firmware Upgrade	-----	40
5-7.	Factory Default	-----	40
CHAP. 6	IRS	-----	41
6-1.	IRS Setup	-----	42
6-2.	DVR Setup	-----	43
6-3.	Viewer	-----	44
6-4.	Search	-----	45
6-5.	Backup	-----	46
6-6.	Player	-----	48
CHAP. 7	DDNS Web-server	-----	51
7-1.	Registering DVR for DDNS	-----	51
7-2.	DDNS set up in DVR	-----	53
7-3.	Web Program	-----	57
CHAP. 8	Specification	-----	58
CHAP. 9	Remote Controller	-----	59

CHAP 1. Features & Package Contents

1-1. Features

Live Display

- Real time display per camera
- Auto Sequence
- PIP (Picture in picture)
- Digital Zoom of display (2X ZOOM)
- Freeze
- Simple playback mode
- Simple PTZ camera control

Record

- Efficient image quality selection in 5 steps
- Audio recording
- Schedule recording
- Event record by alarm and motion detection
- Emergency recording

Network

- IRS (Integrated Remote Station)
- DDNS supported

Playback

- Search and playback by recorded data size, date/time, and event
- Various playback speed (forward and backward)
- Event Search

Data backup

- Backup via USB memory stick / via network

Others

- Supports UNI-CODE
- Supports SPOT Monitor
- PAL/NTSC Auto detection
- Video loss detection

1-2. Package Contents

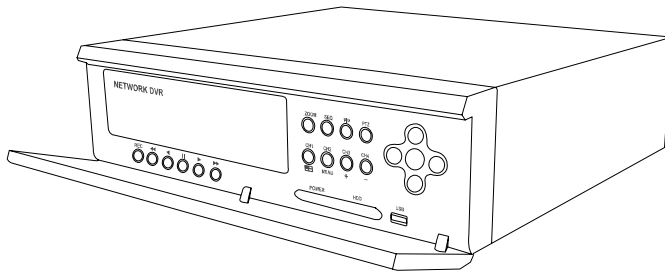

1. DVR Main Unit



2. Remote Controller

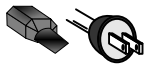

3. Power Cable

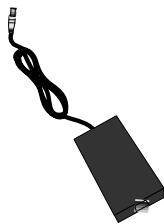

4. Power Adapter

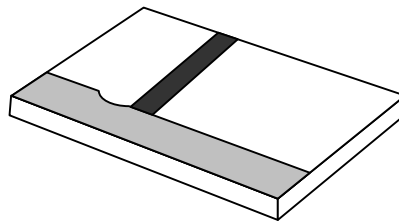

5. User's Manual

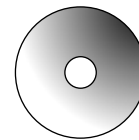

6. Software CD

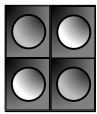

7. Rubber Pad

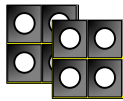

8. HDD absorber



9. HDD Bolts







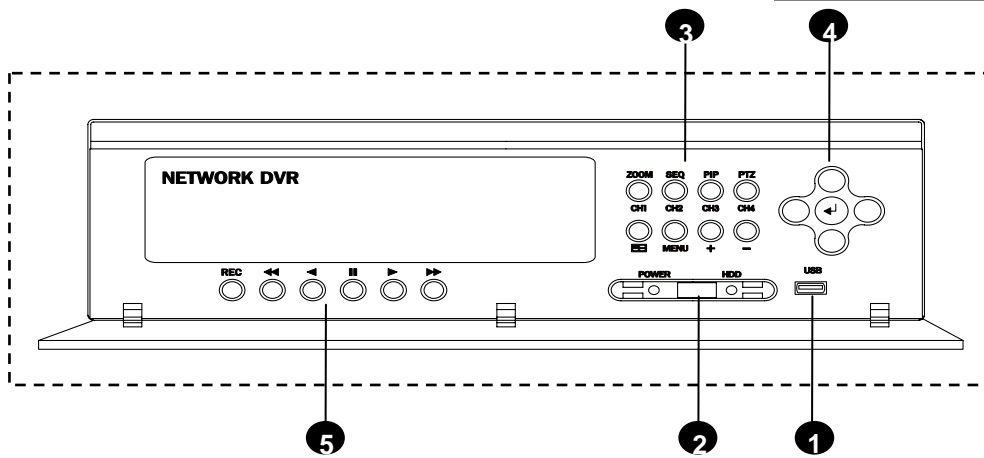

10. Mouse

Package Contents	Description
1. DVR Main Unit	Stand-Alone Digital Video Recorder
2. Remote Controller	Remote controller
3. Power Cable	AC power supply to adapters for 12V DC power
4. Power Adapter	DC power supply
5. User's Manual	User's Manual
6. Software CD	IRS (Integrated Remote Station) program
7. Rubber Pad	Prevents DVR from slipping. Attach it to the bottom of main unit.
8. HDD absorber	Absorbs the mechanical shock of HDD against the case bottom.
9. Bolts	Bolts for fixing HDD.
10. Mouse	Enables to control all functions of DVR.

CHAP 2. Function of Each Button

2-1. Front



Name	Function	
① USB HOST	Used for data backup & firmware upgrade.	
② LED Lamps	Displays current operation status.	
③ Operation buttons	Double-key : 'short press' or 'press & hold'.	
	CH1 / ZOOM	Short press : selects channel no. 1. Press & hold : goes to ZOOM function mode.
	CH2 / SEQ	Short press : selects channel no. 2. Press & hold : goes to sequence function.
	CH3 / PIP	Short press : goes to PIP (picture in picture) mode. Press & hold : selects channel no. 3.
	CH4 / PTZ	Short press : selects channel no. 4. Press & hold : goes to PTZ operation mode.
	MENU	Short press : goes to system menu setup mode. Press & hold : Menu off
		Selects 4-split display or one channel display.
	+ -	Increase or decrease each value. PTZ ZOOM control
④ Arrow buttons		Moves a mouse cursor at system menu / PTZ control
	ENTER	Works like mouse clicking. Selects each category at system menu setup mode.
⑤ Record/playback	REC	Activate emergency recording mode or stops recording at live mode. Gets back to live model from playback mode.
		Increases playback speed
		Backward playback
	II	Pause
		Forward playback
		Decreases playback speed

2-2. Rear

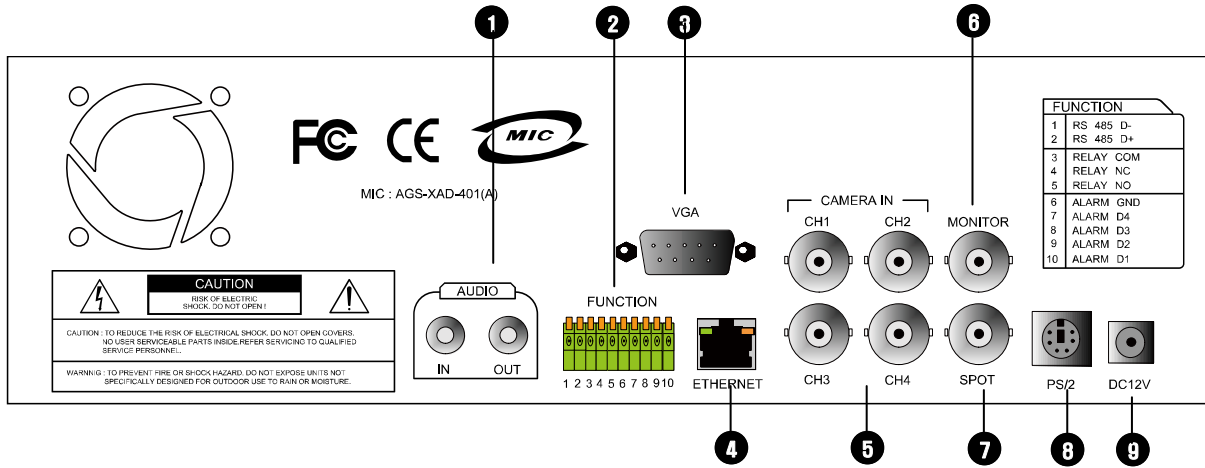

	Name	Function
1	Audio input	1ch audio input
	Audio output	1ch audio output
2	RS 485	Connection with PTZ camera or other external device using RS 485
	Relay output	Relay out terminal
	Sensor input	Sensor input terminal
3	VGA	Connection to VGA monitor (CRT or TFT LCD monitor)
4	Ethernet	Connection to Ethernet device
5	Camera input	4ch camera input (NTSC/ PAL)
6	Monitor output	1ch composite monitor output (NTSC/ PAL)
7	Spot monitor output	1ch spot monitor output (NTSC/ PAL)
8	PS/2	Connection to PS/2 Mouse
9	DC power	DC 12V

CHAP.3 Installation

3-1. Installation configuration



3-1. Installation

1) HDD

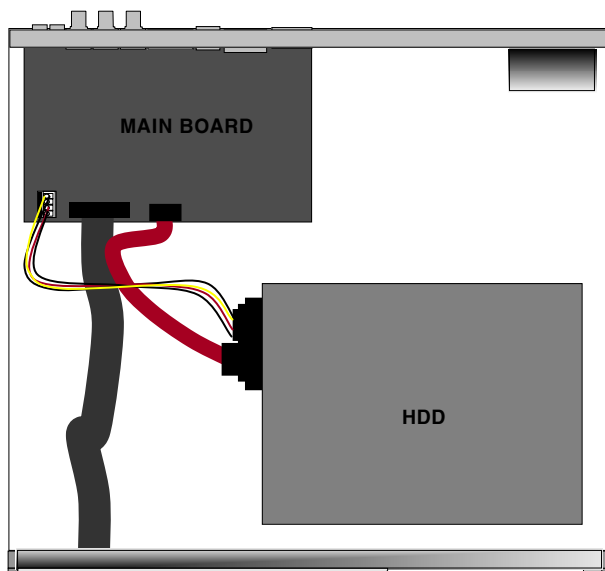

1. Connect Main Board and HDD using SATA data cable and HDD power cable.
2. Stick the HDD absorber (included in package) on the bottom of case and then install the HDD on top of them by using the bolts (included in package).
3. Screws must be inserted from outside of the case bottom.

2) Camera

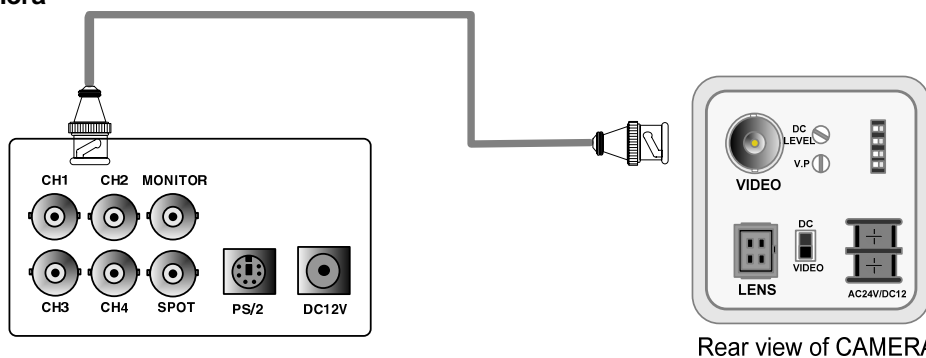

Rear view of CAMERA

Connect camera to the camera input on rear panel of DVR marked CAMERA IN.

3) Monitor

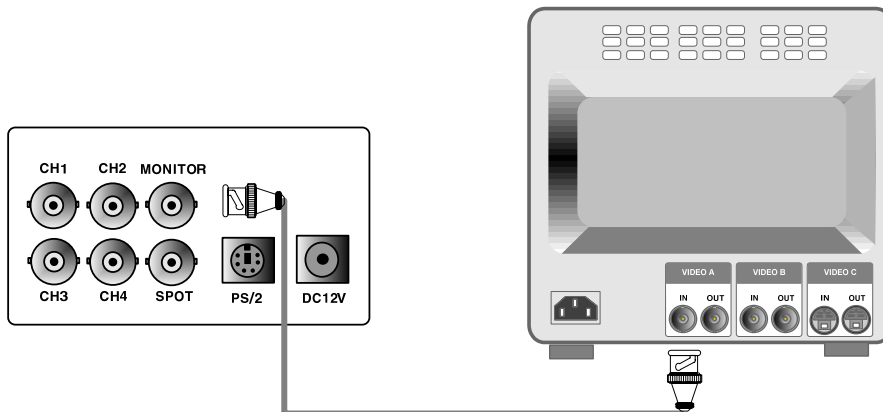

Connect the video output marked MONITOR to Video-In of Main monitor.

4) Power

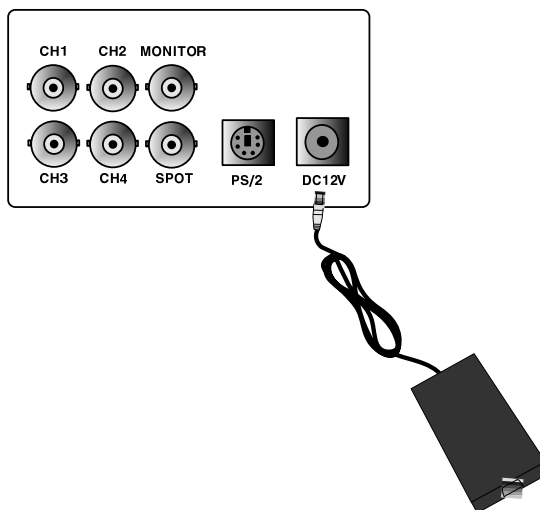

DC over 12V adapter

5) Other External Device

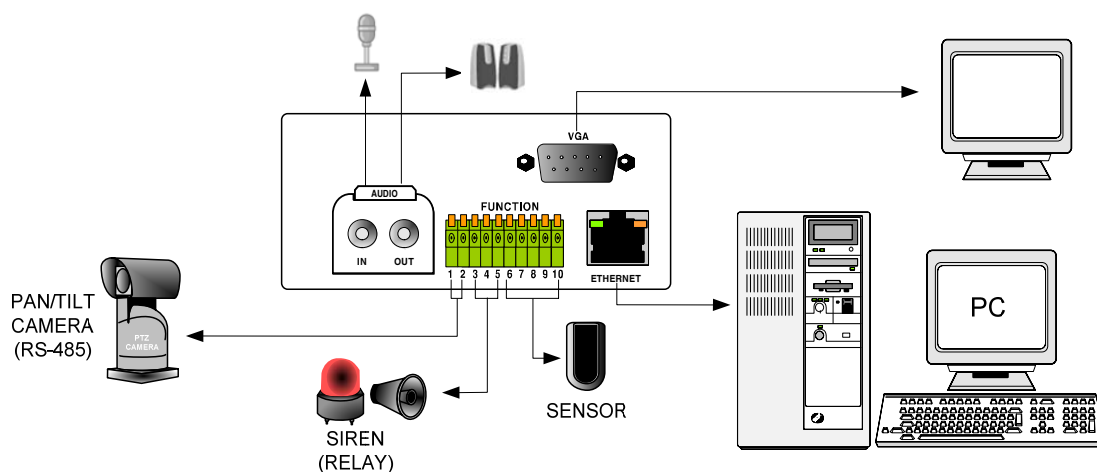

RS-485 : Controls external device like PTZ camera.
(Pin No.1 & No.2)

RELAY Output : Relay Output (Pin No.3 & No.5).

SENSOR Input : Sensor Input – Alarm Input (Pin No.6 ~ No.10).

ETHERNET: Connection to LAN, WAN

Audio Input: Connection to a microphone

Audio Output: Connection to a speaker

VGA : Connection to CRT or TFT LCD monitor (D-SUB)

4-1. System Log-In

GENERAL USE OF MOUSE

Mouse buttons	Functions
Mouse Wheel	Increases or decreases setup value on the Menu mode
Right	Decreases setup value on the Menu mode
Left	Increases setup value on the Menu mode Execute all of the functions (clicking icons)

* Please use a mouse pad for proper operation of the mouse.

- 1) After power on, a right-click of the mouse shows an icon bar on the screen. Then click the [Menu] icon  to log in.
- 2) Then, you will see 'DVR Log-In' message shown at right.
- 3) You may log in as an ADMIN, MANAGER, or USER1 ~ USER8.
- 4) Input your password (Max. 8 digits are available for password) and click 'ENTER'.
- 5) To exit, click 'EXIT' button.

DVR LOG-IN

USER ID
USER PW

ADMIN

1 2 3 4 5 6 7 8 9

ENTER EXIT

If the password entered matches previously set password, you can log into 'MAIN MENU'. If an incorrect password is entered, you will see "PW IS NOT CORRECT" message on display. The factory default password is none. Just click 'ENTER' for first time initial log in.

-Factory default password
 ADMIN : (Blank)
 MANAGER : '1'
 USER1~USER8 : '2'~'9'

- ※ For security reasons, be sure to make note of your own password.
- ※ The authority of MANAGER & USERS for changing critical settings of DVR is limited due to security reasons.

4-2. HDD Clear & Factory Default

Before first operation, you must check that each channel is displaying properly and log in 'Main Menu' and set Time/Date and set HDD clear.

1) HDD Clear

You can see HDD Model name, serial number, number of blocks and size of HDD.
In order to clear HDD, click 'CLEAR' at the bottom as shown below.

(1) Please refer to 4-1. System Log in again.

Then, click 'ENTER'.

DVR LOG-IN									
USER ID									ADMIN
USER PW									_____
1	2	3	4	5	6	7	8	9	
				ENTER					EXIT

(2) Click 'EXTERNAL DEVICE'.

MAIN MENU	
DISPLAY SETUP	
RECORD	
CONFIGURATION	
EXTERNAL DEVICE	
BACK-UP	
FIRMWARE UPGRADE	
FACTORY DEFAULT	
LANGUAGE	ENGLISH
	EXIT

(3) Click 'HDD MANAGEMENT'.

CONFIGURATION	
HDD MANAGEMENT	
CAMERA SETUP	
MOTION SETUP	
ALARM SETUP	
INTERVAL SETUP	
TIME/DATE SETUP	
PASSWORD SETUP	
BUZZER SETUP	
	ESC

(4) Click 'CLEAR'.

HDD MANAGEMENT	
MODEL	WDC WD3200JS-60PDB0
SERIAL	WD-WCAPD3768692
BLOCKS	1048576 LBA
SIZE	250 GB
SPEED	PIO4

OVERWRITE	ENABLE
	CLEAR
	ESC

(5) Please refer to 4-1. System Log in again.

Then, click 'ENTER'.

DVR LOG-IN									
USER ID									ADMIN
USER PW									_____
1	2	3	4	5	6	7	8	9	
				ENTER					EXIT

(6) Now you can see
"HDD CLEAR IS COMPLETED".

HDD MANAGEMENT	
MODEL	WDC WD3200JS-60PDB0
SERIAL	WD-WCAPD3768692
BLOCKS	1048576 LBA
SIZE	250 GB
SPEED	PIO4

OVERWRITE	ENABLE
HDD CLEAR IS COMPLETED	
	CLEAR
	ESC

2) Factory Default

Factory default setting initializes DVR system.

(1) Please refer to 4-1. System Log in again.

Then, click 'ENTER'.

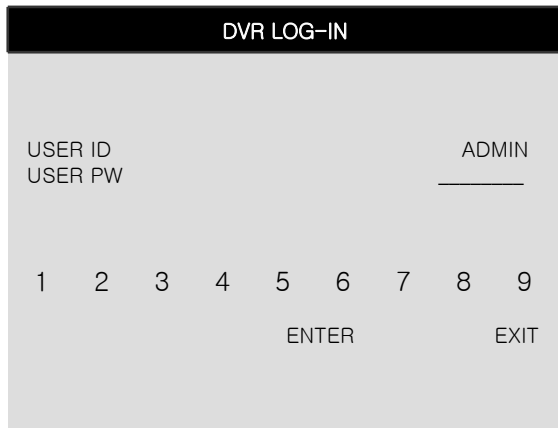

(2) Click 'FACTORY DEFAULT'.

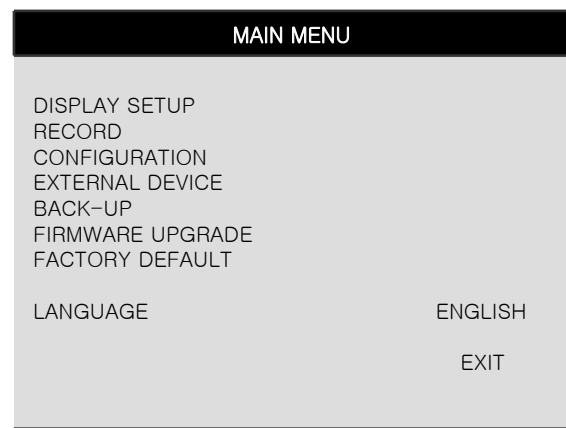

(4) Choose ON for 'ALL'.

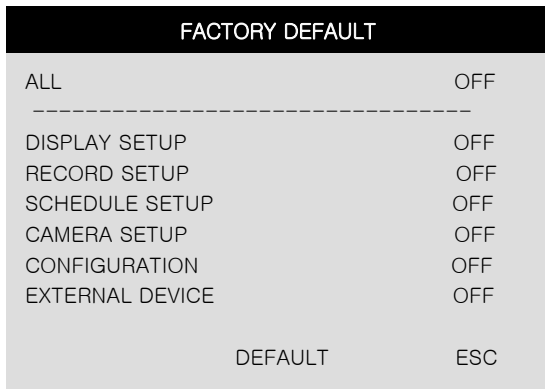

(2) Click 'DEFAULT'.

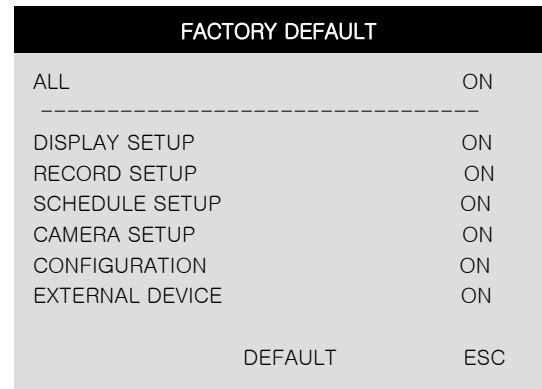

(5) Now you can see "FACTORY DEFAULT COMPLETED" as shown below.

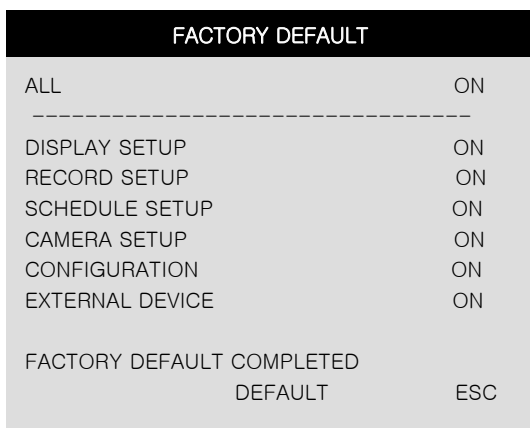

4-3. Display Configuration

ETHERNET connection status icon

- Disconnected
- Connected
- Network search

Emergency Record & Schedule record [RED]

Stop Recording [GREEN]

HDD space display (Possible recording days)

OVERWRITE status icon

- * shown when overwrite is ENABLE
- * not shown when overwrite is DISABLE
- * blinking during OVERWRITE

Playback

- Search
- Freeze
- Sequence
- Zoom
- PIP
- PTZ
- Menu
- Emergency recording start
- Emergency recording stop

Audio On [Gray]

Audio Off [Blue Green]

Volume Off

PTZ mode

PIP mode

ZOOM mode

SEQ mode

FRZ mode

Ch No.1 single display

Ch No.2 single display

Ch No.3 single display

Ch No.4 single display

4 - split display

Live Display

※ If you click during schedule record mode, it goes to emergency record mode.

※ Once you click , it goes back to schedule record mode.

HDD space display (Location of the current playback image in HDD)

Playback display

- FASTEST PLAY
- FAST PLAY
- FORWARD PLAY
- PAUSE
- BACKWARD PLAY
- FAST BACKWARD
- FASTEST BACKWARD PLAY

MENU

- MOVE TO THE BEGINNING
- BACKWARD PLAY
- PAUSE
- FORWARD PLAY
- MOVE TO THE END
- INCREASE PLAYBACK SPEED
- DECREASE PLAYBACK SPEED
- SEARCH
- EXIT

Playback Display

4-4. Live View Setup

1) Full / Multiple View

Move the cursor onto [4 – split icon]  in the icon bar and click it to view 4 channel division. To enlarge each channel, click 1,2,3,4 Icon. Then, you will see a channel in full screen mode.

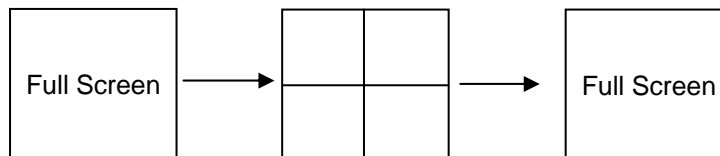

2) SEQ

Click 'SEQ' icon . It automatically displays full screen images in sequence. You can setup SEQ time interval on setup menu. (MAIN MENU -> CONFIGURATION -> INTERVAL SETUP -> SEQUENCE SCREEN)

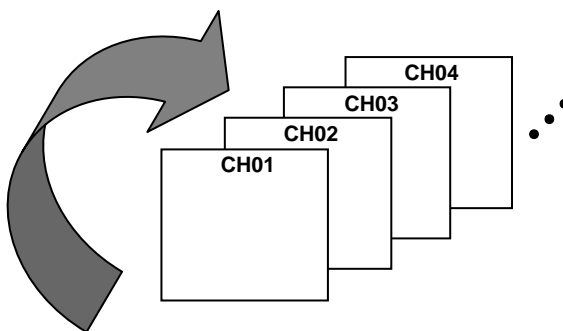

3) Picture in Picture (PIP View)

When it is in full screen display mode, you can see other camera in a small window by clicking [PIP] icon , the other camera in small window is rotating in sequence to next number of camera and you can set the rotating time interval as per the procedure in MAIN MENU -> SCREEN SETUP -> PIP INTERVAL -> PIP SCREEN.

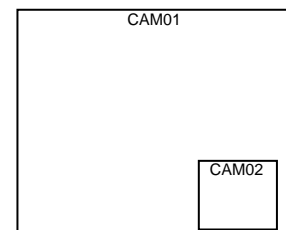

4) ZOOM View

In live mode, if you click [ZOOM] icon , images are displayed in two times larger size. While using [ZOOM] mode, you can move the enlargement area by using the mouse. To exit ZOOM mode, click ZOOM icon again.

5) Freeze

Click [FRZ] icon  and click a channel that you want to freeze temporarily in live mode. If you click [FRZ] icon again, it will cancel all.

4-5. Record

It basically records as a setting made in Schedule Record mode except for emergency record mode.

- Emergency Record
Once you click this icon , it keeps recording continuously regardless of schedule setting.
- Schedule Record (Continuous, Motion, Alarm and Motion/Alarm)
Go to MAIN MENU-> RECORD -> SCHEDULE SETUP and setup schedule as you want.
It records as a setting.
- Record Icon in Red indicates Emergency Record and Schedule Record.

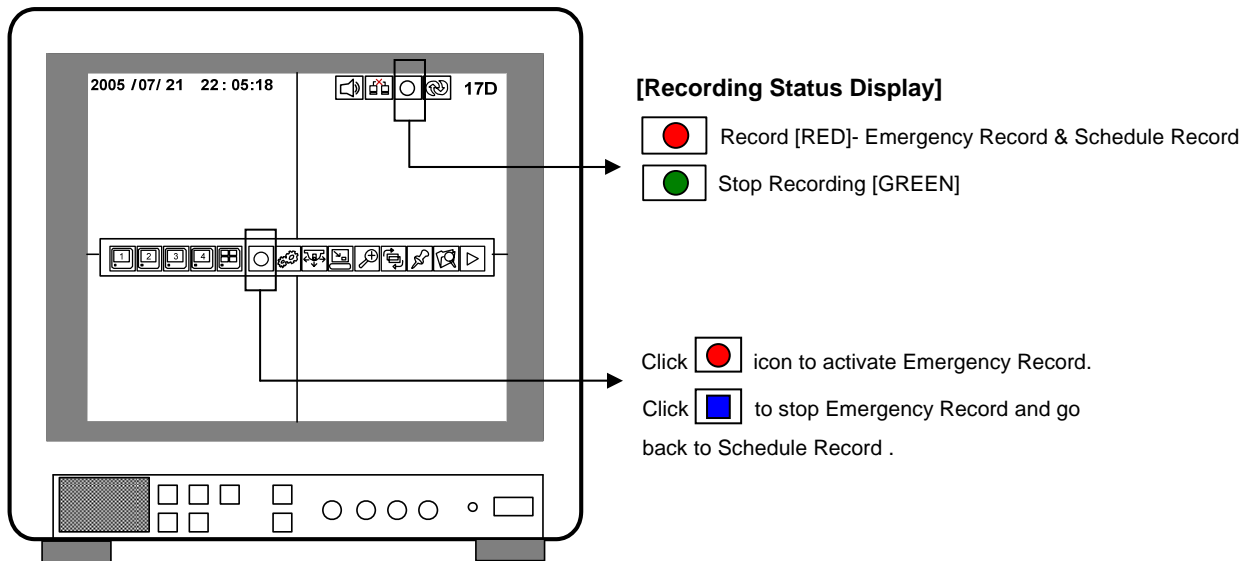

- This DVR unit does not record in following conditions :

- ※ When overwrite function is off and HDD is full
- ※ When there is no scheduled recording
- ※ When you update a firmware
- ※ When there is no event detected in motion, alarm and motion/alarm record mode of schedule record setting.

4-6. Playback

On record mode or live mode, click [playback] icon  to play the recorded data in 1x speed.

4-7. Search

There are three search methods controlled by a mouse wheel button, left and right button of a mouse. When you click [SEARCH] icon , then you see a window shown as below. Select a target data by using the mouse. In PERCENT SEARCH Mode, you can select certain data by clicking on the bar. To move to the previous mode, click 'ESC'.

1. PERCENT SEARCH

Search by percentage of total recorded data. It starts from image corresponding to set % of data on the search bar.

2. TIME/DATE SEARCH

Search by time & date. Playback starts from the time & date selected.

3. EVENT SEARCH

Search by event list (Motion, Alarm, Video Loss)

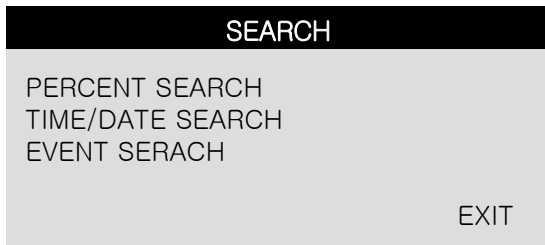

SEARCH MAIN MENU

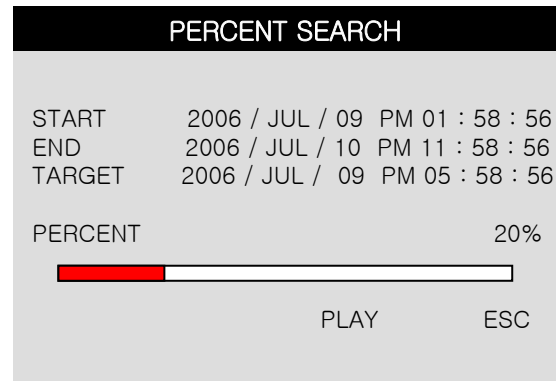

PERCENT SEARCH



TIME/DATE SEARCH

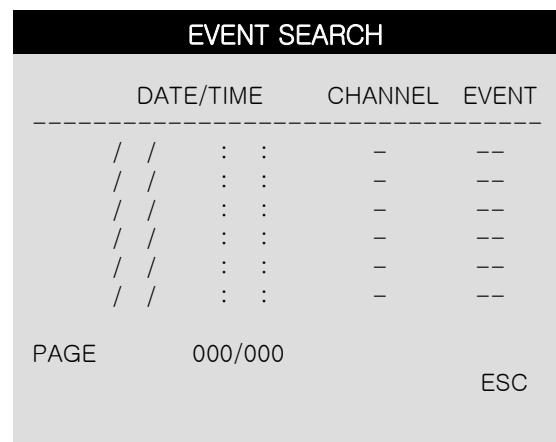

EVENT SEARCH

4-8. PAN/TILT/ZOOM Camera Operation

Click [PTZ] icon  in the icon bar, then you can see 'arrow' keys & '+/-' key shown below. Click these arrow keys to move a PTZ camera to each direction. By using '+/-' key, you can control ZOOM IN/OUT function. ('+' : ZOOM IN / '-' : ZOOM OUT)

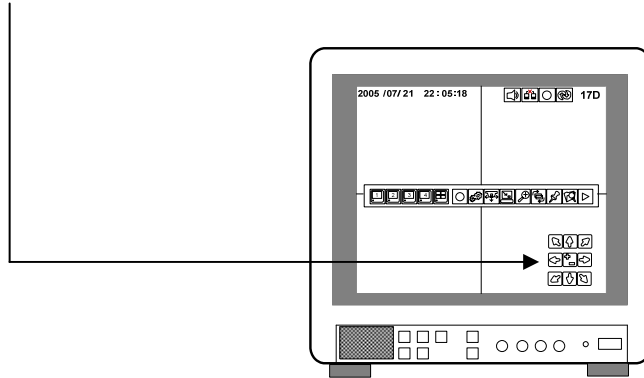

4-9. Data Backup

Right-click to see the icon bar and click [MENU] icon  and go to 'Backup'.

(1) Please refer to 4-1. System Log in again. (2) Click 'BACK-UP'.

Then, click 'ENTER'.

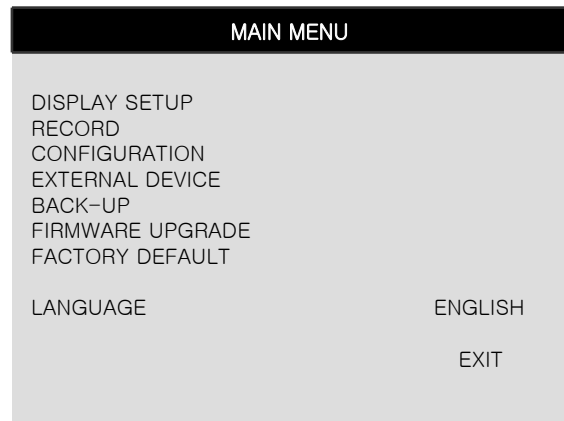
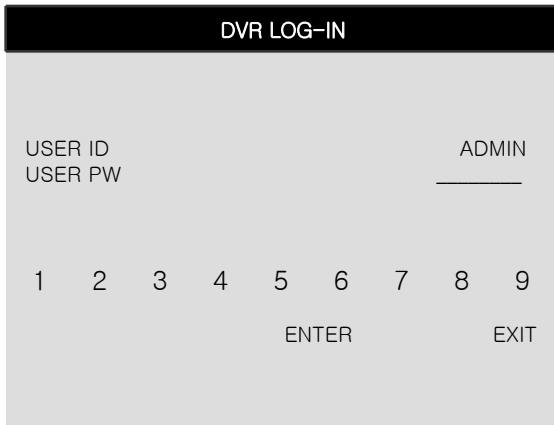

(3) Insert USB memory stick and click 'CHECK USB'.

※ The START & END time / date in HDD sub-menu only shows start and end of recording. This is not selectable and editable.

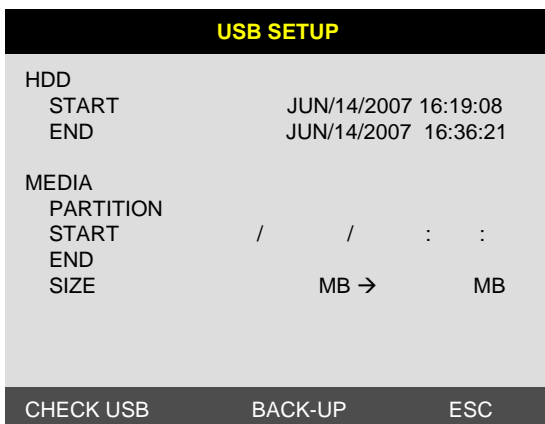

※ Only USB memory stick should be used for backup.

- (4) To set start time of back-up and back-up data size in MEDIA sub-menu, use the mouse (left/right/wheel button).
- ※ End time of back-up will be calculated automatically as per start time & date and the back-up data size you set.
 - ※ You can select the back-up data size (size of back-up data from start of back-up), but END of back-up time is automatically determined by DVR itself.
- (5) Click 'Back-up' to start USB back-up.

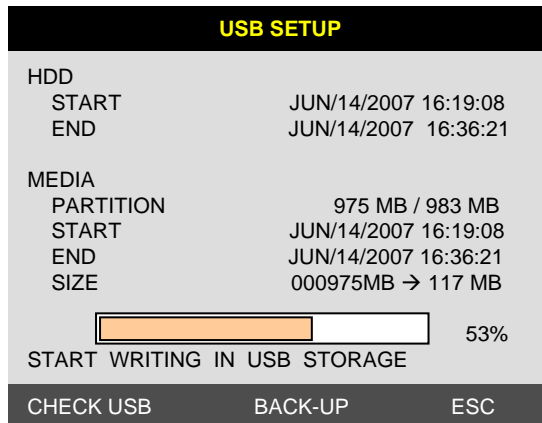

- (6) You can verify the back-up by installing and running the Player on your PC.
Refer to 6-3. Viewer

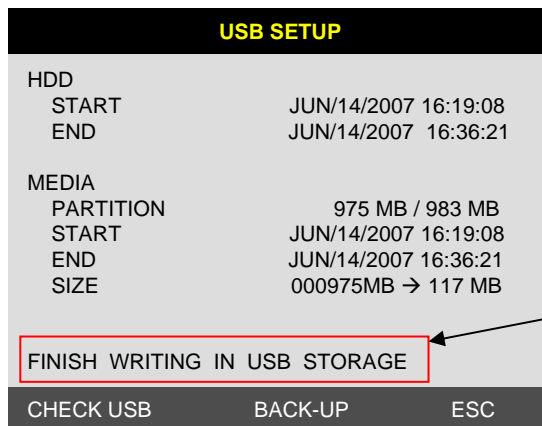

System Status Messages

- (1) When MEMORY STICK is recognized
 - USB STORAGE IS CHECKING ...
 - USB STORAGE IS AVAILABLE
- (2) During Back-Up
 - START WRITING IN USB STORAGE
 - FINISH WRITING IN USB STORAGE
- (3) Error Messages
 - THERE IS A PROBLEM ON USB PORT
(If USB PORT fails to work properly or not connected)
 - INPUT DATE TIME ERROR
(If you select incorrect date & time, not in between START and END time in HDD.)
 - RECORD DATA IS NOT AVAILABLE
(When USB memory stick is full or backup data file size is 0MB)

CHAP 5. Setup

5-1. General Operation

Click the [MENU] icon  and input user password to log in.

(1) Please refer to 4-1. System Log in again.

Then, click 'ENTER'.

DVR LOG-IN										
USER ID									ADMIN	
USER PW									_____	
1	2	3	4	5	6	7	8	9		
							ENTER	EXIT		

MAIN MENU	
DISPLAY SETUP	
RECORD	
CONFIGURATION	
EXTERNAL DEVICE	
BACK-UP	
FIRMWARE UPGRADE	
FACTORY DEFAULT	
LANGUAGE	ENGLISH
	EXIT

MAIN MENU

5-2. Display Setup

This is setup menu for display on the screen.

If you click 'DISPLAY SET UP', then you change setting values for display as shown below.

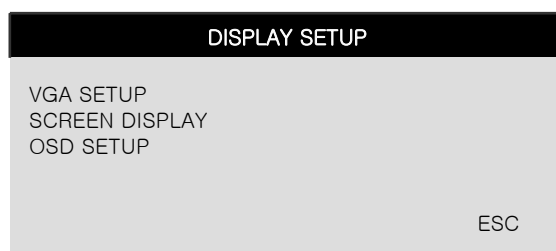

1) VGA Setup



VGA SETUP : Sets RESOLUTION for a VGA monitor (TFT LCD or CRT) as shown below.
Default Resolution for VGA is 800x600.

640X480 / 60Hz	640X480 / 75Hz
800X600 / 60Hz	800X600 / 75Hz
1024X768 / 60Hz	1024X768 / 75Hz
1280X1224 / 60Hz	1280X1024 / 75Hz

**** Please check the resolution range that your VGA monitor supports first before you use VGA monitor. If you select high resolution such as 1024X768, 1280X1024 on VGA SETUP with VGA monitor that does NOT support those high resolutions, image display may NOT be seen properly.**

2) Screen Display Setup

SCREEN DISPLAY		
VERTICAL POSITION		24
HORIZONTAL POSITION		00
BOARDER ENABLE		ON
BOARDER COLOR		GRAY
	DEFAULT	ESC

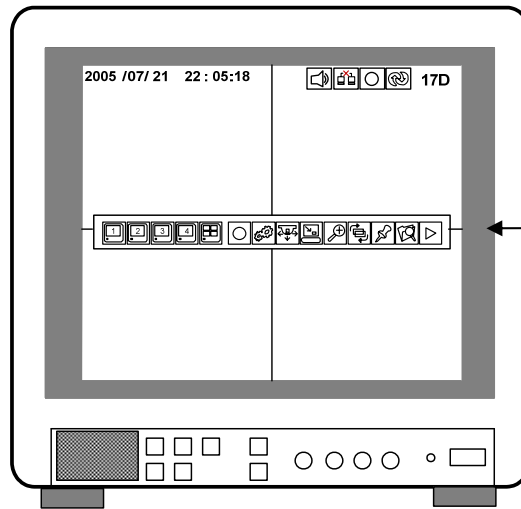

VERTICAL POSITION : -5 ~ 5
 HORIZONTAL POSITION : -31 ~ 31
 BORDER ENABLE : ON/OFF
 BORDER COLOR : COLOR SELECT

3) OSD Setup

OSD SETUP		
TOP OSD OFFSET		0
	DEFAULT	ESC

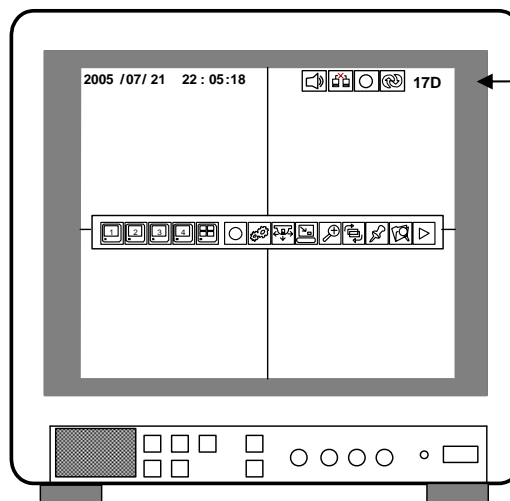

TOP OSD OFFSET : -1 ~ 1

5-3. Record

This is the most important configuration of the DVR. When you select 'RECORD SETUP' in the main menu, you can see the window as shown below.



1) Record Setup

(1) QUALITY : 5 step selectable

- Highest
- High
- Normal
- Low
- Lowest

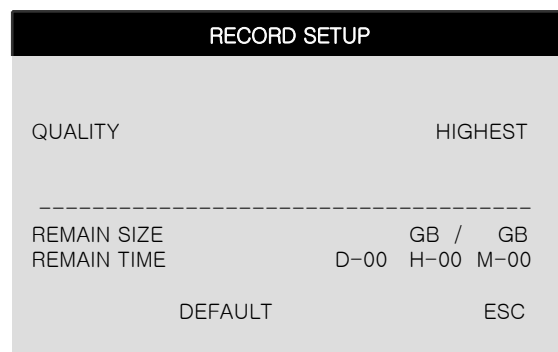

(2) REMAIN SIZE

Indicates HDD capacity remains by size (GB). / Indicates total HDD capacity (GB).

(3) REMAIN TIME

Indicates HDD capacity remains by time.





D- days, H- hours, M- Minutes

2) Schedule Setup

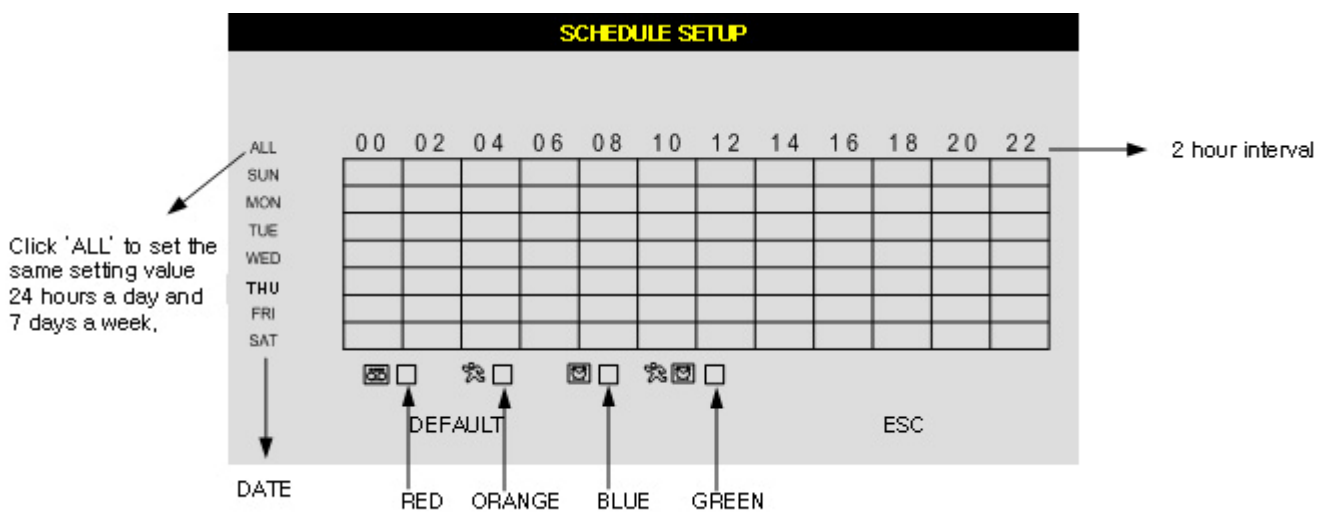
DVR system records in Schedule Recording mode. In Schedule Recording mode, you can choose four different types of recording modes and schedule by 2 hour interval from Sunday to Saturday. Default recording mode is continuous recording.

Set Recording time interval for a day of the week (Time interval : by 2 hour) and recording type.



-  : 24 hour continuous recording (Red color)
-  : Motion recording (Orange color)
-  : Alarm recording (Blue color)
-  : Motion & Alarm recording (Green color)

※ Default setting is continuous recording.

※ Each recording type is indicated in different color of boxes.

You can set up schedule by dragging the mouse. In this case, the recording type of the boxes dragged is same as the one that you initially select. All blocks can be activated or deactivated by using 'ALL' button.

※ Once you set up schedule record, DVR records as it is scheduled in normal times.

In emergency situation, you can click  icon to make DVR record continuously.

To exit emergency recording mode and go back to scheduled recording mode, click  icon.
(please see page 15)

5-4. Configuration

When you click 'CONFIGURATION' on the main menu, you can go to 'CONFIGURATION' menu as shown on the right.

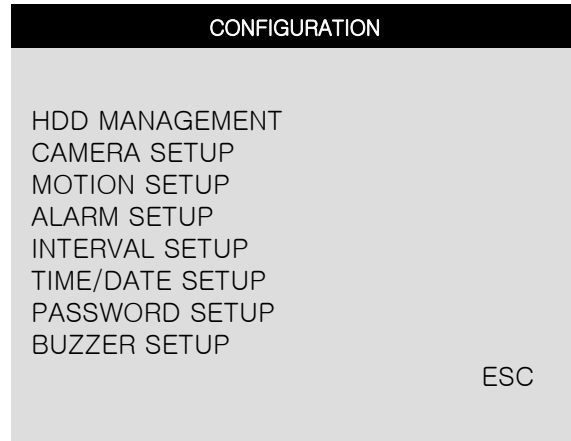

1) HDD Management

You can see HDD Model name, serial number, number of blocks and size of HDD. You can also clear HDD. (While you are in this HDD MANAGEMENT Mode, DVR does NOT record.)

MODEL : HDD MODEL NAME
 SERIAL : HDD SERIAL No.
 BLOCKS : HDD LBA BLOCK Number
 SIZE : HDD TOTAL SIZE
 SPEED : HDD MODE
 OVERWRITE : ENABLE, DISABLE

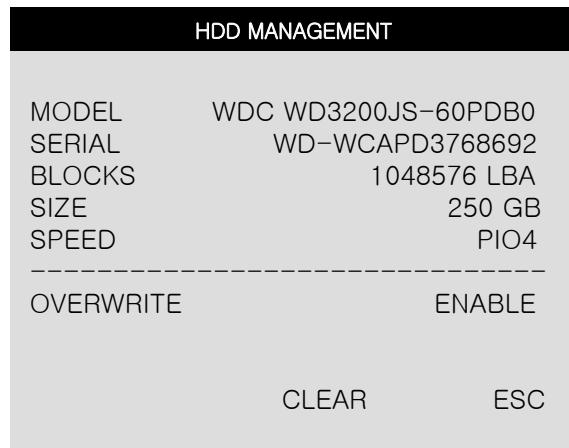

What is OVERWRITE?

- When HDD is full, the oldest data in HDD is automatically deleted as DVR records new data.

2) Time/Date Setup

In this setup, you can select date/time of DVR system and display format.

You can adjust values by using the mouse wheel or left/right button of the mouse.

※ For the first time installation, date/time setup must be completed first.

DATE FORMAT : DATE(ASIAN/EUROPEAN
/AMERICAN)
HOUR FORMAT : (12H/24H)
MONTH FORMAT : (ENGLISH,NUMERIC)

TIME/DATE SETUP	
DATE	JUN/15/2007
TIME	15:41 :45
DATE FORMAT	AMERICAN
HOUR FORMAT	24HOUR
MONTH FORMAT	ENGLISH
	DEFAULT ESC

3) Camera Setup

You can setup values for each camera.

CAMERA SETUP		
CHANNEL		CH1
TITLE		CAM01__
BRIGHTNESS		1
CONTRAST		7
SATURATION		14
HUE		-32
DEFAULT	ALL-DEFAULT	ESC

(1) CHANNEL : You can select a channel which you want to change values.

(2) TITLE : You can name each camera with 8-digit number or letter combination.

Move the cursor onto a location that you want and choose numbers or letters by using mouse wheel or left/right button of the mouse. To exit to the previous menu mode, click 'ESC'.

DEFAULT = CAM01__ ~ CAM03__

(3) COLOR : You can adjust color, for each camera by using the mouse.

BRIGHTNESS : Adjust brightness (-32 ~ 31) [DEFAULT = 1]

CONTRAST : Adjust contrast (-32 ~ 31) [DEFAULT = 7]

SATURATION : Adjust saturation (-32 ~ 31) [DEFAULT = 14]

HUE : Adjust hue (-32 ~ 31) [DEFAULT = -32]

(4) Executing Buttons

ALL-DEFAULT : Initializing all values for all channel as a default setting value.(CH1 ~ CH4)

DEFAULT : Initializing all values, for the applied channel, only as a default setting value.

ESC : Use to exit

4) Motion Setup

MOTION SETUP

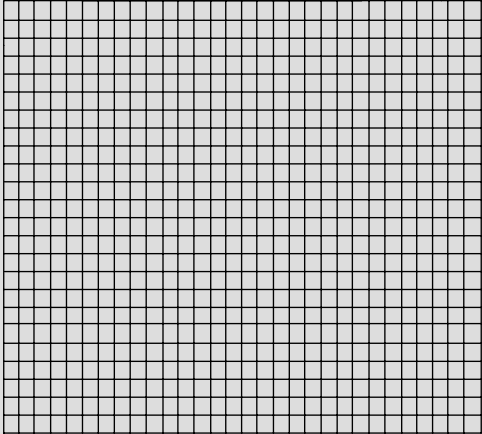
CHANNEL	CH1	
SENSITIVITY	6	
DURATION	05	
SIZE	2	

DEFAULT
ALL-DEFAULT
ESC

MOTION SETUP: You can change values by mouse wheel and left/right button of the mouse.

- SENSITIVITY: Adjust sensitivity of a movement. You can adjust level 1 ~ level 7.
[DEFAULT : 6]
- DURATION : Whenever motion is detected (set in Motion Recording mode),
DVR records for a certain time from the point when motion is detected.
(2 sec.~99 sec.) [DEFAULT : 5 sec.]
- SIZE : Select the CELL SIZE for Blocked Area (RED).
(1,2,3,6, and ALL) [DEFAULT : 2]
- ALL-DEFAULT: Default setup for all channels

MOTION MASK SETUP : Set motion detection area.

- CELL : Move to the cell and then decide to make it activated or deactivated by clicking it.
When the cell is activated, motion is detected. Motion is not detected on
deactivated cells.
Whenever you click a cell, it changes between activated and deactivated.

BLOCK SETUP: First, you decide 'Activated' or 'Deactivated' by clicking a cell.

Then, if the initial cell is 'Activated', the blocks dragged by the mouse are also activated.

If the initial cell you select is deactivated, the blocks dragged are also deactivated.

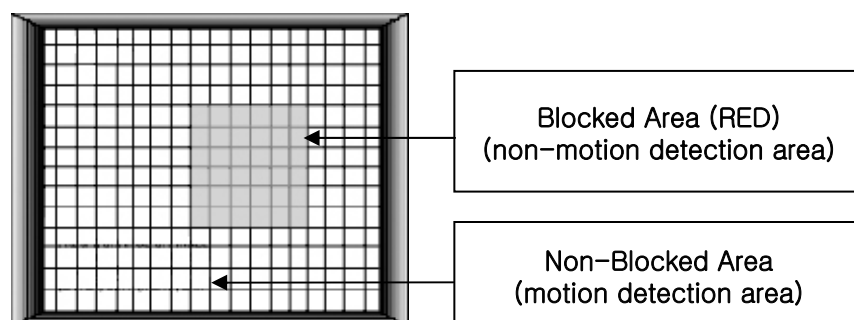

5) Interval Setup

See the switching time interval for SEQ or PIP function.
(1 sec. ~99 sec.)

SEQUENCE SCREEN :Set the sequencing switch time interval in live full screen.

PIP SCREEN : Set the sequencing switch time interval of PIP window.

EVENT UPDATE : Set the minimum time interval of event to be listed on EVENT LIST.

If EVENT UPDATE time is set at 10 sec, only following event happened 10 sec or more than 10 sec later previous event shall be listed on EVENT LIST.

INTERVAL SETUP			
SEQUENCE SCREEN		01 SEC	
PIP SCREEN		01 SEC	
EVENT UPDATE		600 SEC	
	DEFAULT		ESC

6) Alarm Setup

Set type of alarm sensors connected to DVR unit.
N.O represents Normal Open type and N.C Normal Close type.

INPUT : Select NORMAL OPEN, NORMAL CLOSE, or DISABLE.

DISABLE represents no use of alarm sensor connected to DVR.

DURATION : Set the duration of alarm when an ALARM is activated. (2 sec. ~ 99 sec.)

ALARM SETUP			
CHANNEL		CH1	
INPUT		DISABLE	
DURATION		01 SEC	
	ALL-DEFAULT	DEFAULT	ESC

7) Password Setup

Set user ID and Password.

You can make up to 8-digit number combination for a password by clicking number '1' ~ '9' on password setup menu.

To change password, you need to click 'USER PW' first to activate the menu.

You must input current password and then input new password.

And input again new password to confirm.

PASSWORD SETUP									
USER ID									ADMIN
USER PW									-----
NEW PW									-----
CONFIRM									-----
	1	2	3	4	5	6	7	8	9
							ENTER		ESC

Number selection for password

※ Changing the user Password in the first operation is recommended.

8) Buzzer Setup

You can select Buzzer OFF/ON on this setup menu.

BUZZER SETUP	
KEY TONE	ON
VIDEO LOSS	ON
ALARM ACTIVE	ON
MOTION DETECT	ON
DEFAULT	ESC

5-5. External Device Setup

Please refer to 4-1. System Log in again.

Then, click 'ENTER'.

DVR LOG-IN									
USER ID							ADMIN		
USER PW							_____		
1	2	3	4	5	6	7	8	9	
							ENTER		EXIT

Click 'EXTERNAL DEVICE'

MAIN MENU	
DISPLAY SETUP	
RECORD	
CONFIGURATION	
EXTERNAL DEVICE	
BACK-UP	
FIRMWARE UPGRADE	
FACTORY DEFAULT	
LANGUAGE	ENGLISH
	EXIT

Set parameters of external devices connected to DVR like Ethernet, Mouse, etc.

If you click EXTERNAL DEVICE on the main menu, then you will see the window shown on the right.

EXTERNAL DEVICE	
TCP/IP SETUP	
PAN/TILT SETUP	
MOUSE SETUP	
AUDIO SETUP	
	ESC

1) TCP/IP Setup

TCP/IP function enables you to see live pictures and recorded pictures via the Internet.

TCP/IP SETUP	
IP SETUP	
DDNS SETUP	
	ESC

(1) IP Setup :

Shows the network information assigned to the DVR unit. If the DHCP setup status is AUTOMATIC, you can set the IP port only. If the DHCP setup status is MANUAL, you must set all parameters. If IP port number is blocked, a network specialist's advice is needed.

IP SETUP	
MAC ADDRESS	00-0A-A2-00-FD-63
DHCP MODE	MANUAL IP DETECT
IP PORT	50000
IP ADDRESS	192.168.001.160
GATEWAY	192.168.001.001
SUBNET	255.255.255.255
	ESC

A. Static IP



A static IP address is a number (in the form of a dotted quad) that is assigned to a computer by an Internet service provider (ISP) to be its permanent address on the Internet. Input IP address which is assigned by your ISP in IP CONFIG SETUP.

- 1) Verify if IP address is OK or not with PC before connecting DVR.
(or inquires to Internet service provider that assigned IP address, GATEWAY, SUBNET MASK)
- 2) Connect LAN cable to DVR after confirmation.
- 3) DVR : MENU → LOG IN DVR → EXTERNAL DEVICE → TCP/IP SETUP → IP SETUP .
- 4) Set DHCP to MANUAL.
- 5) Verify if MAC ADDRESS starts from 00-0A-A2...
- 6) Input the assigned IP address.
- 7) Set IP PORT. (50000 recommended)
- 8) Input GATEWAY (which is assigned by your ISP).
- 9) Input SUBNET MASK (which is assigned by your ISP).
- 10) Go out of MENU SETUP.
- 11) Turn off and on Modem (Router) which is provided by your ISP.
→ This is to reset client of MAC from your ISP.
Wait 30 seconds after turning on.
- 12) Access DVR with Remote Viewer Software.
See a chap.6 IRS

IP SETUP	
MAC ADDRESS	00-0A-A2-**-**-**
DHCP MODE	MANUAL IP DETECT
IP PORT	50000
IP ADDRESS	211.118.047.160
GATEWAY	211.118.047.001
SUBNET	255.255.255.255
	ESC

← Assigned by your Internet Service Provider

* If user fails to access, please verify 1,6,7,8,9,11 again.

B. Dynamic IP

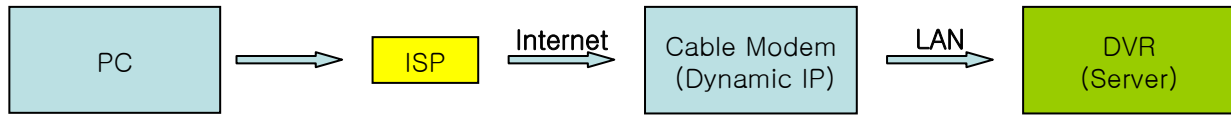

This contrasts with a Dynamic IP address, wherein an IP address is assigned to a computer, usually by a remote server which is acting as a Dynamic Host Configuration Protocol server. IP addresses assigned using DHCP may change depending on the addresses available in the set scope. Dynamic IP Addresses assigned by Dynamic Host Configuration Protocol servers are used because it creates efficiency within a network.

If you set 'AUTOMATIC' for DHCP Type on TCP /IP setup menu, IP information is automatically assigned from ISP's DHCP.

- 1) Verify if IP address is OK or not with PC before connecting DVR.
(The internet connection confirmation)
- 2) Connect LAN cable to DVR after confirmation.
- 3) Turn off and on Modem (Router) which is provided by ISP company.
→ This is to reset client of MAC from ISP company.
Wait 30 seconds after turning on.
- 4) Turn off and on DVR.
- 5) DVR: MENU → LOG IN DVR → EXTERNAL DEVICE→TCP/IP SETUP → IP SETUP.
- 6) Verify if MAC ADDRESS starts from 00-0A-A2...
- 7) Set DHCP to AUTOMATIC and click 'IP DETECT'.
- 8) Set DHCP to MANUAL
- 9) Go out of MENU SETUP after getting IP successfully.
- 10) Access DVR with Remote Viewer Software.
See a chap.6 IRS

IP SETUP	
MAC ADDRESS	00-0A-A2-**-**-**
DHCP MODE	AUTOMATIC
	IP DETECT
IP PORT	50000
IP ADDRESS	211.118.047.160
GATEWAY	211.118.047.001
SUBNET	255.255.255.255
	ESC

IP SETUP	
MAC ADDRESS	00-0A-A2-**-**-**
DHCP MODE	MANUAL
	IP DETECT
IP PORT	50000
IP ADDRESS	211.118.047.160
GATEWAY	211.118.047.001
SUBNET	255.255.255.255
	ESC

Assigned by your Internet Service Provider

* If user fails to access, please verify 1,3,4,7,8 again.

C. Dynamic IP of PPPoE (DSL)

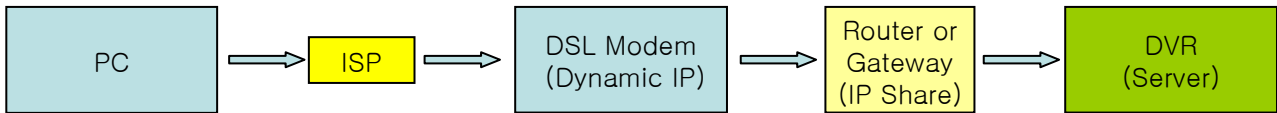

DVR doesn't support DSL (PPPoE), user will need to set NETWORK with IP SHARE in order to access DVR remotely. At this time, user will need to port forward on DVR. Please contact IP SHARE Manufacturer if you need to know how to forward port.

Even though the user may have a Static/Dynamic IP, if you want to use another device (PC) through IP SHARE, set NETWORK as follows

- 1) Verify if IP address is OK or not with PC before connecting DVR.
(The internet connection confirmation)
- 2) Connect Router (IP SHARE) to DSL modem as shown the following picture.
- 3) Set the Internet connection on Router (IP SHARE). (Refer to the Router Manual).
- 4) Verify if sub-group of network in Router is OK or not.
- 5) Connect DVR to Router.
- 6) DVR : MENU → LOG IN DVR → EXTERNAL DEVICE → TCP/IP SETUP → IP SETUP.
- 7) Set DHCP to AUTOMATIC and click IP DETECT.
- 8) Set DHCP to MANUAL
- 9) Verify if MAC ADDRESS starts from 00-0A-A2...
- 10) Set IP PORT, (50000 recommended)
- 11) Go out of MENU SETUP.
- 12) Forward port from Router (Refer to the next page).
- 13) Access DVR with external IP and Port (Port forwarded).

* If Router supports DDNS, user can access Remote Viewer using Domain Information.

IP SETUP	
MAC ADDRESS	00-0A-A2-**-**-**
DHCP MODE	AUTOMATIC IP DETECT
IP PORT	50000
IP ADDRESS	192.168.001.160
GATEWAY	192.168.001.001
SUBNET	255.255.255.255
ESC	

IP SETUP	
MAC ADDRESS	00-0A-A2-**-**-**
DHCP MODE	MANUAL IP DETECT
IP PORT	50000
IP ADDRESS	192.168.001.160
GATEWAY	192.168.001.001
SUBNET	255.255.255.255
ESC	

* If user fails to access, please verify 1,4,7,8,12 again.

If you are using a router, please setting up DMZ and Port Forwarding instructions below.

[How to set DMZ]

- Set DMZ as per router manual, if you want to connect a DVR by using one internet line.
- Setting procedure and name of DMZ may be various from router manufacturers.
- For more detail information, please refer to router manual.

One example of how to set DMZ is shown below.

- 1) Access to your router. (Please refer to router manual provided by a router manufacturer.)
- 2) Find 'Applications & Gaming' and go to 'DMZ'.
- 3) Click 'Enable' and input IP address on 'DMZ Host IP Address'.
- 4) Click 'Save Settings' to save.



[How to do Port Forwarding]

- Set Port Forwarding as per router manual, if you want to connect to several DVRs by using one internet line.
- Setting procedure and name of Port Forwarding may be various from router manufacturers.
- For more detail information, please refer to router manual.

One example of how to do Port Forwarding is shown below.

- 1) Access to your router. (Please refer to router manual provided by a router manufacturer.)
- 2) Find 'Applications & Gaming' and go to 'Port Range Forward' on the menu.
- 3) Input Port number of your DVR on 'Start' / 'End' section below.
- 4) Input IP Address and check 'Enable'. Then, click 'Save Settings' to save.

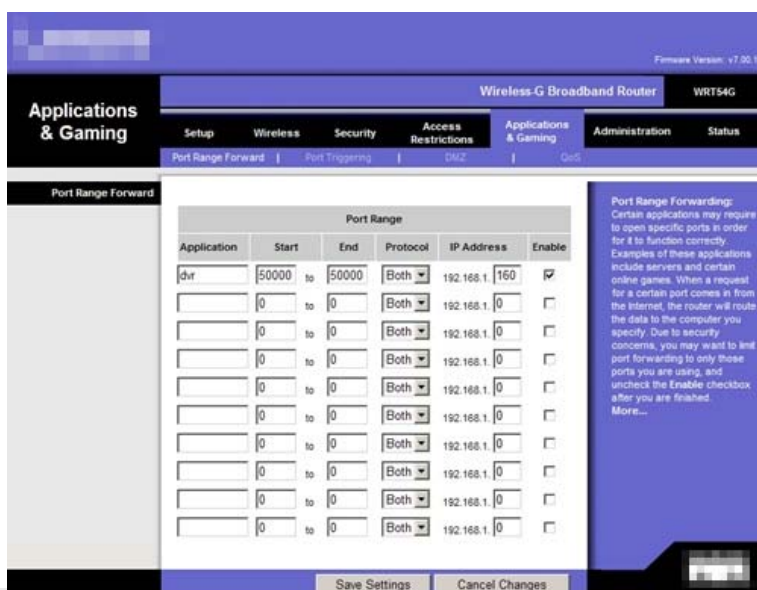

D. Direct connect to DVR

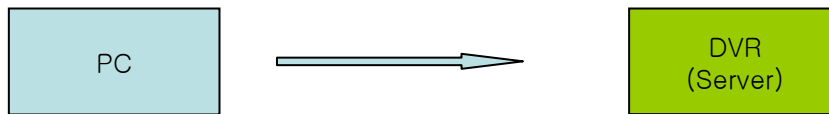

When you try to connect to DVR directly, you must use DIRECT CABLE.

a. PC's TCP/IP Setting

1. For WindowsXP/2000, Click [start] – [Control Panel] click

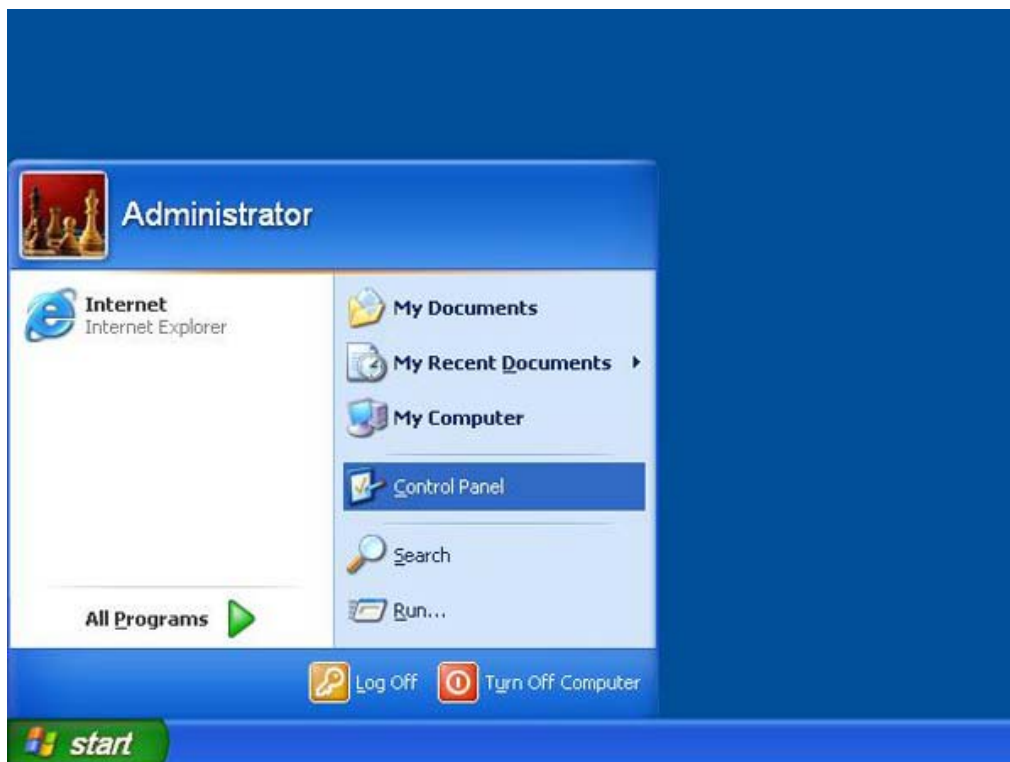

2. Double click [Network Connections]

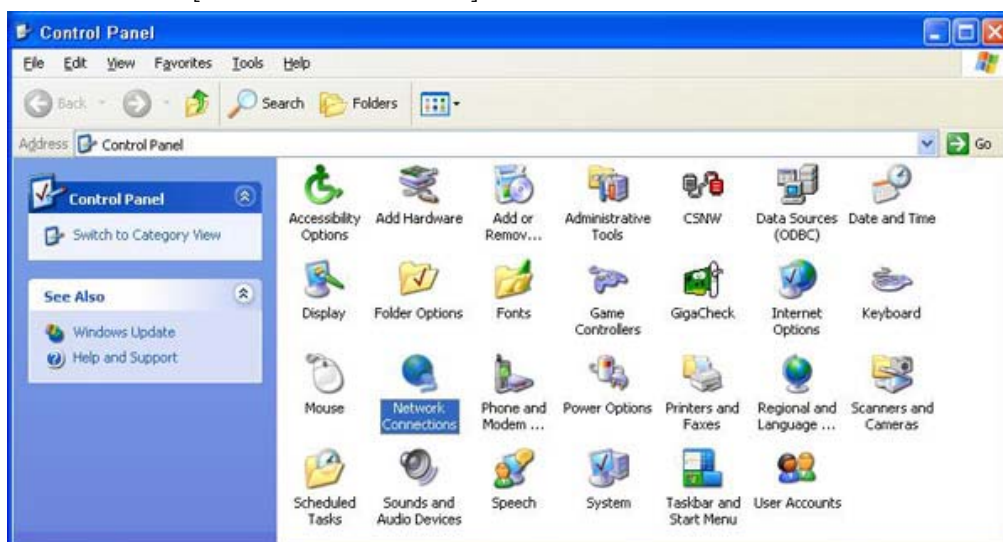

3. Right-button click [Local Area Connection]

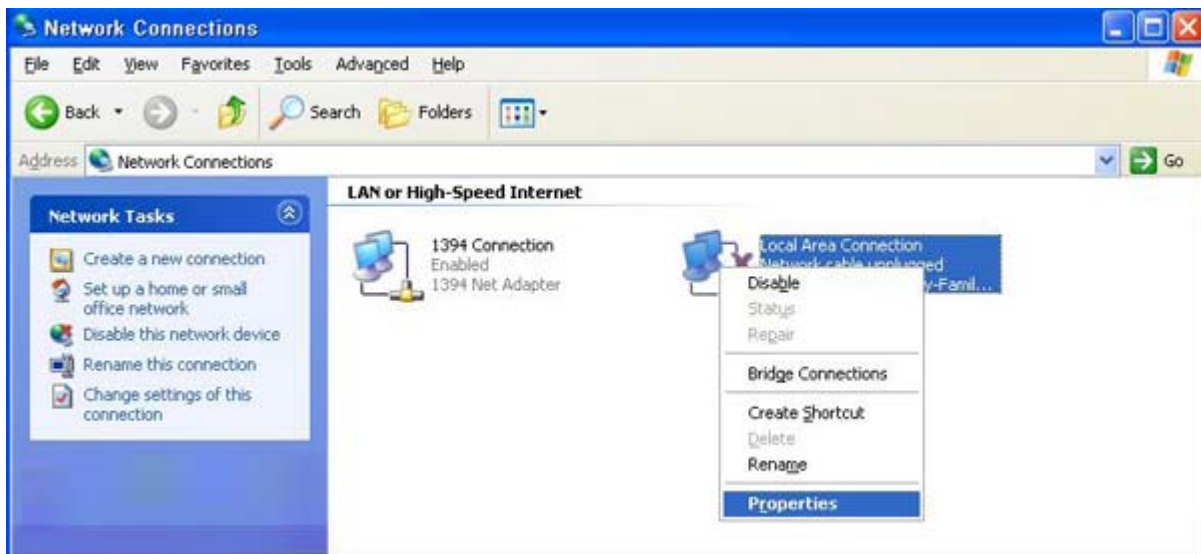

4. Click 'Properties' [General] – [Internet Protocol (TCP/IP)]

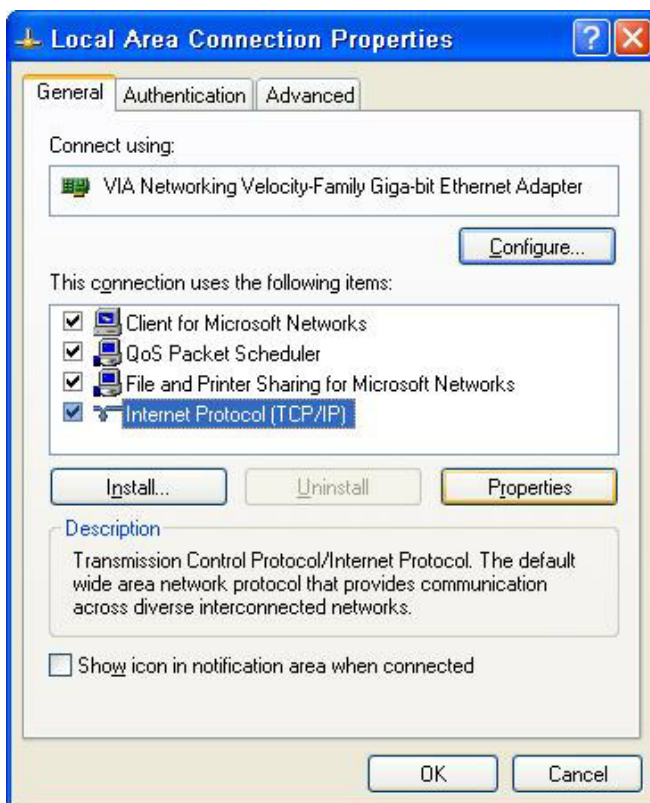

5. IP Address Setting

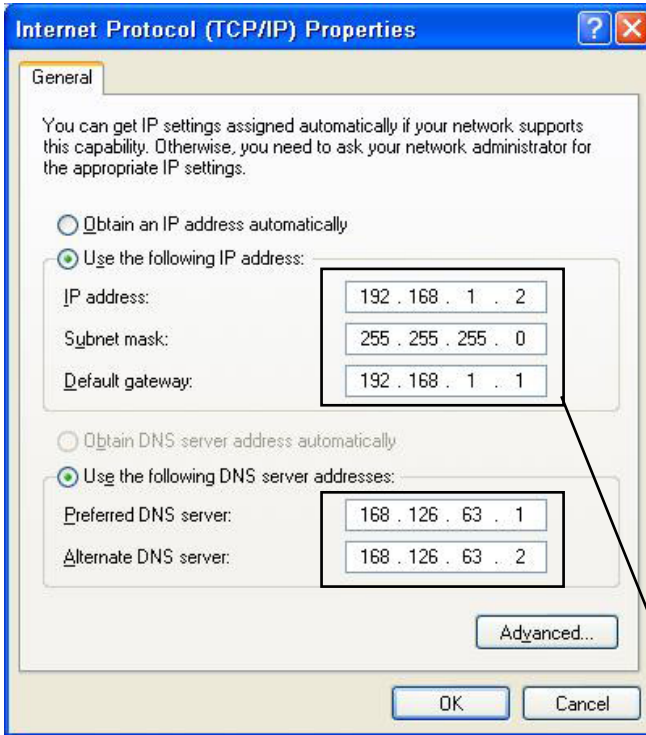

IP Address : AAA.BBB.CCC.DDD
 AAA.BBB.CCC is identical with DVR's setting
 DDD with DVR's setting is not same

Subnet mask must be 255.255.255.0

Default gateway is AAA.BBB.CCC.1
 AAA.BBB.CCC is identical with HUB's Address

DNS Server is different in the country and ISP Supplier.
 When PC does not using internet, if it does not input, it is irrespective.

Setting example

b. DVR Setting

Please reaffirm DVR setting

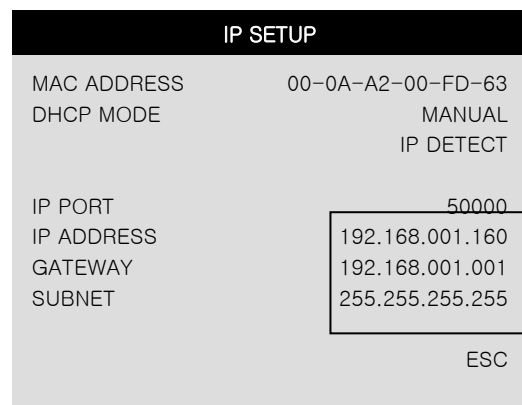
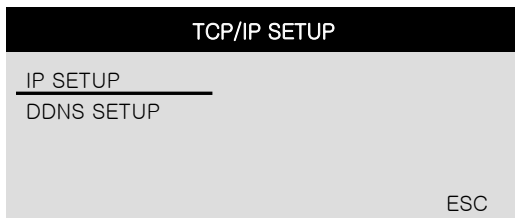
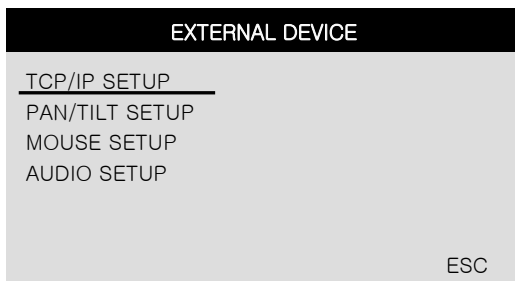

(2) DDNS Setup :

Please refer to CH.8 DDNS Setup
for more information.

Refer to CH7-2 DDNS set up in DVR on page 53.

DDNS SETUP	
DDNS ENABLE	OFF
DNS SERVER	192.168.063.001
INTERVAL	D-00 H-00 N-20 REGISTER
DDNS STATUS	
IP ADDRESS	
IP PORT	
REMAIN TIME	
LAST REGISTRATION DATE	
	ESC

2) Pan/Tilt Setup

PAN/TILT SETUP	
COMMAND SETUP	← PTZ Camera setup
SPEED SETUP	← PTZ Speed setup
ESC	

PAN/TILT SETUP	
PAN SPEED	7
TILT SPEED	7
ZOOM SPEED	7
DEFAULT	ESC

COMMAND SETUP	
CHANNEL	01
MODEL	PELCO-D
PTZ ID	000
BAUDRATE	002400 BPS
CMD DELAY	1 MSEC
COMMAND	PAN/TILT STOP
LENGTH	16
CODE	00 00 00 00
	00 00 00 00
	00 00 00 00
	00 00 00 00
DEFAULT	ALL-DEFAULT ESC

- (1) CHANNEL : Selects channel
- (2) MODEL : Selects camera model (protocol type) per each channel
- (3) PTZ ID : Selects PTZ ID (per each channel)
- (4) BAUDRATE : Selects data transmission speed
- (5) CMD DELAY : Selects command delay time

3) Mouse Setup

If you increase sensitivity, mouse cursor moves fast.

MOUSE SETUP	
SENSITIVITY	3
DEFAULT	ESC

4) Audio Setup

If you select a channel, the audio of the selected channel is recorded.

- (1) CHANNEL : By selecting a channel, you can set audio recording ON/OFF.
- (2) INPUT VOLUME : Volume setup for microphone
- (3) OUTPUT VOLUME : Volume setup for speaker

AUDIO SETUP	
CHANNEL	CH1
INPUT VOLUME	00
OUTPUT VOLUME	00
DEFAULT	ESC

5) Spot Setup

- (1) SWITCHING INTERVAL
Channel switching time (01 sec. ~ 99 sec.)
- (2) ALARM POP-UP
When ALARM is detected, the image of channel connected with Alarm sensor pops up.
Set ALARM detection pop-up (ON/OFF)
- (3) MOTION POP-UP
Set MOTION detection pop-up (ON/OFF)

SPOT SETUP	
SWITCHING INTERVAL	01 SEC
ALARM POPUP	ON
MOTION POPUP	ON
EVENT POPUP DURATION	05 SEC
DEFAULT	ESC

※ EVENT POP-UP DURATION

If events (MOTION or ALARM) happen on several channels at the same time, channel No. 1 has the first priority to pop up. For example, if events happen on channel No. 1, channel No. 2, and channel No. 4 at the same time, channel No. 1 pops up. If the motion disappears on channel No. 1, then channel No. 2 pops up for the time duration that you set. However, even though motion happens on channel No. 1 again within the duration, channel No. 2 still displays. If motion on channel No.1 keeps on going even after the duration, channel No. 1 pops up again.

5-6. Firmware Upgrade

When it comes to firmware upgrade, you may ask your local dealer.

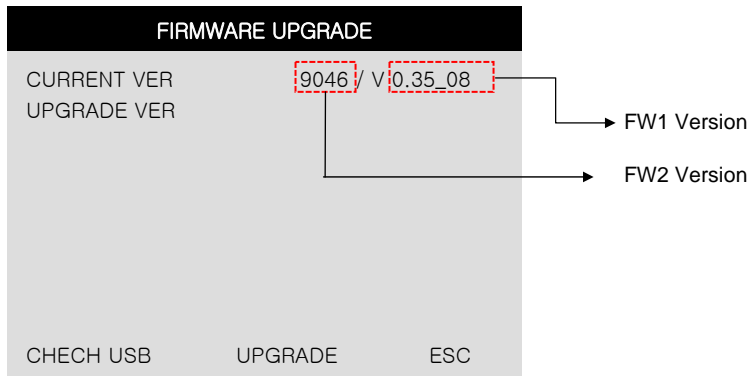

5-7. Factory Default

Factory default setting initializes DVR system.

Select categories below that you want to initialize and choose ON. Then, click 'Default' button. In order to initialize all of the categories below, choose ON for 'ALL'. Then, click 'Default' button. Please refer to CH.4-2 Factory default again. (see page14)

FACTORY DEFAULT	
ALL	OFF

DISPLAY SETUP	OFF
RECORD SETUP	OFF
SCHEDULE SETUP	OFF
CAMERA SETUP	OFF
CONFIGURATION	OFF
EXTERNAL DEVICE	OFF
DEFAULT	ESC

CHAP 6. IRS (Integrated Remote Station)

MAIN INTERFACE



IRS SETUP	Inputs information for IRS network connection.
DVR SETUP	Changes DVR setting over a network.
VIEWER	Enables to show live image display.
SEARCH	Enables to search and show recorded image display.
BACKUP	Enables to back up recorded images in DVR to your PC.
PLAYER	Enables to play the backup images on your PC. (AM4 file)

※ Interface and functions of IRS are subject to change without prior notice.

6-1. IRS Setup

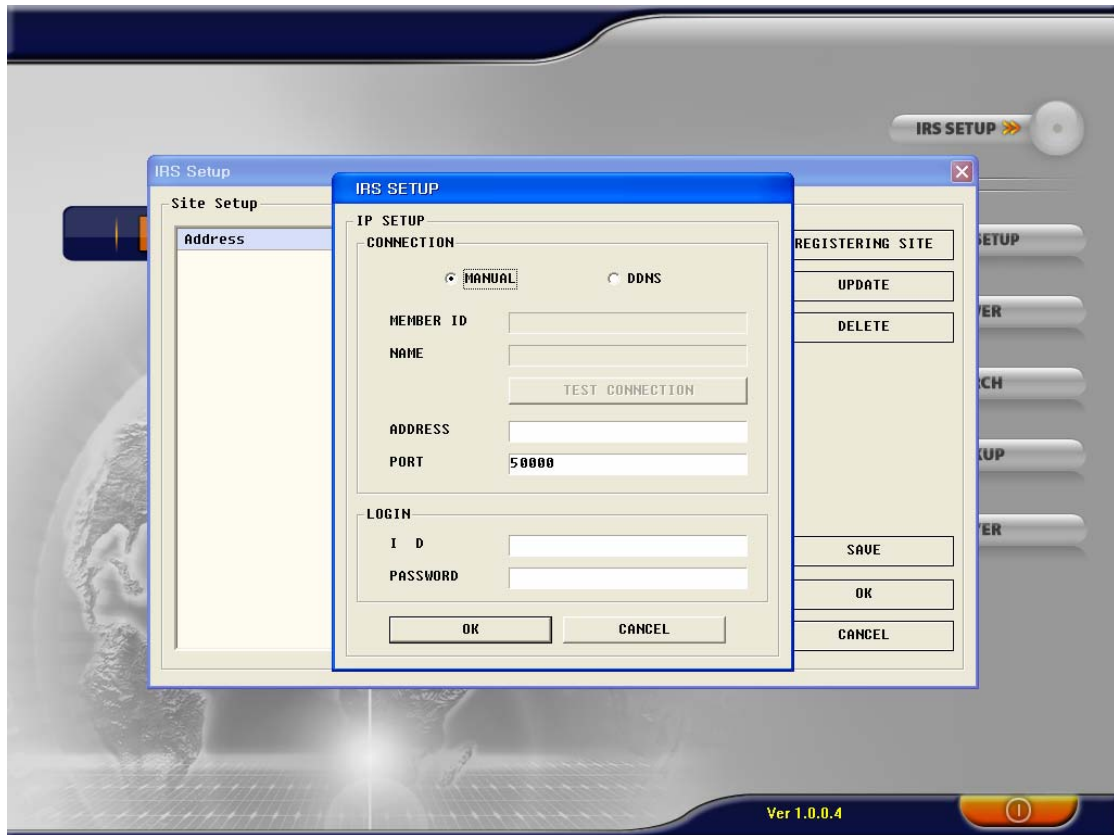

- MANUAL** Select "Manual" to input IP address and port number manually.
- DDNS** Select "DDNS" to use IP address and port number that you already registered in DDNS server. (For more information about DDNS, please refer to page 54~59.)
- MEMBER ID** Input member ID that you registered in DDNS server.
- NAME** Input DVR name that you registered in DDNS server.
- ADDRESS** Input IP address manually.
- PORT** Input port number manually.
- LOGIN**
- ID** Input DVR ID which has been set in DVR already. (Input 'admin'.)
- Password** Input password of DVR.

※ Interface and functions of IRS are subject to change without prior notice.

6-2. DVR Setup

The screenshot shows a web-based interface for connecting to a Network DVR. The central area is a large grey rectangle with the text "Wait To Connection". To the right is a control panel with a "MANUAL" tab selected. Under this tab, there are four input fields: "ADDRESS", "PORT NUMBER" (with the value "50000" entered), "ID", and "PASSWORD". Below these fields are two buttons: "CONNECT" and "DISCONNECT". Further down, the version number "Ver 1.0.0.1" is displayed. At the bottom right of the panel is a "CLOSE" button.

You can change some settings of DVR listed below over a network.

(Alarm, Buzzer, Interval, Record Configuration, Record Schedule, Audio)

MANUAL Input IP address and port number of DVR manually.

ADDRESS Input IP address of DVR manually.

PORT NUMBER Input port number of DVR manually.

LOGIN

ID Input DVR ID which has been set in DVR already. (Input 'admin'.)

PASSWORD Input password of DVR.

CLOSE Click "CLOSE" to exit.

※ Interface and functions of IRS are subject to change without prior notice.

6-3. Viewer

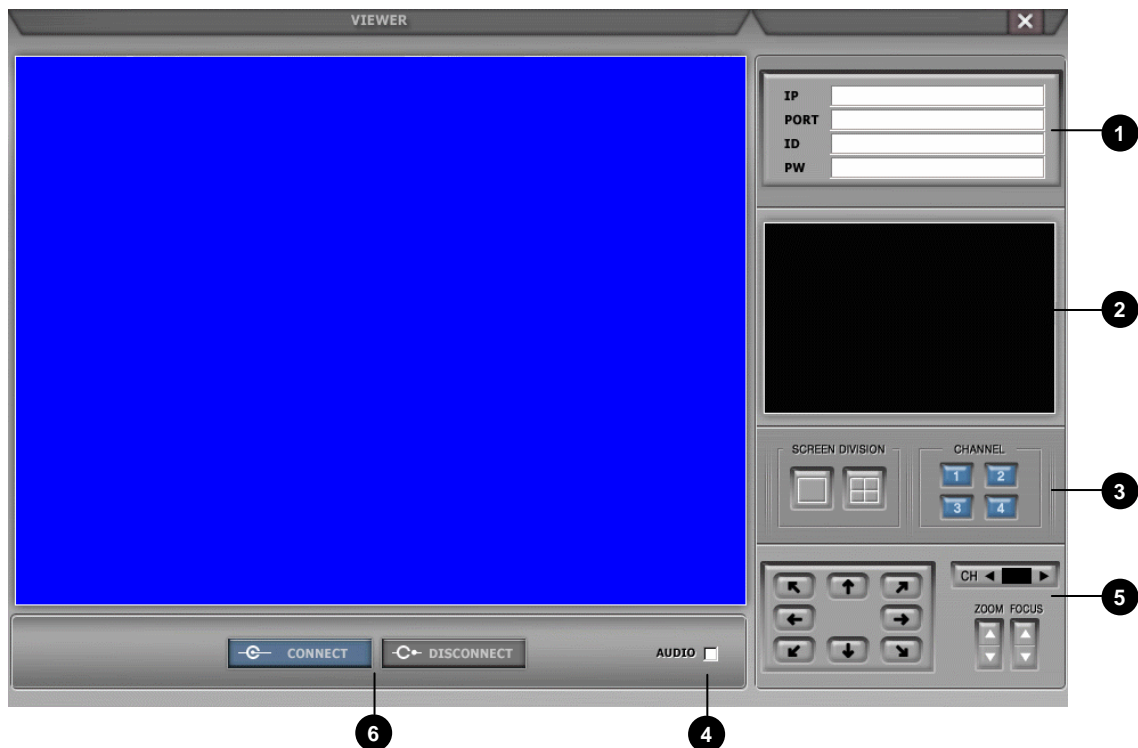

- 1 **DVR connection setup** : Input network information to connect.
(IP / PORT / ID / PW)
- 2 **System information** : Displays connection status and operating information.
- 3 **Screen display**
 - a) SCREEN DIVISION : Selects full screen mode or 4-split mode
 - b) CHANNEL : Displays full screen for each channel.
- 4 **Audio** : Set Audio ON/OFF.
- 5 **PTZ control** : Controls PTZ camera remotely.
(In order to control PTZ camera, PTZ setting in DVR must be completed in advance.)
- 6 **Network connection**
 - a) CONNECT : Click this button to connect to DVR & see live view over a network.
 - b) DISCONNECT : Click this button to disconnect.

※ Interface and functions of Viewer are subject to change without prior notice.

6-4. Search

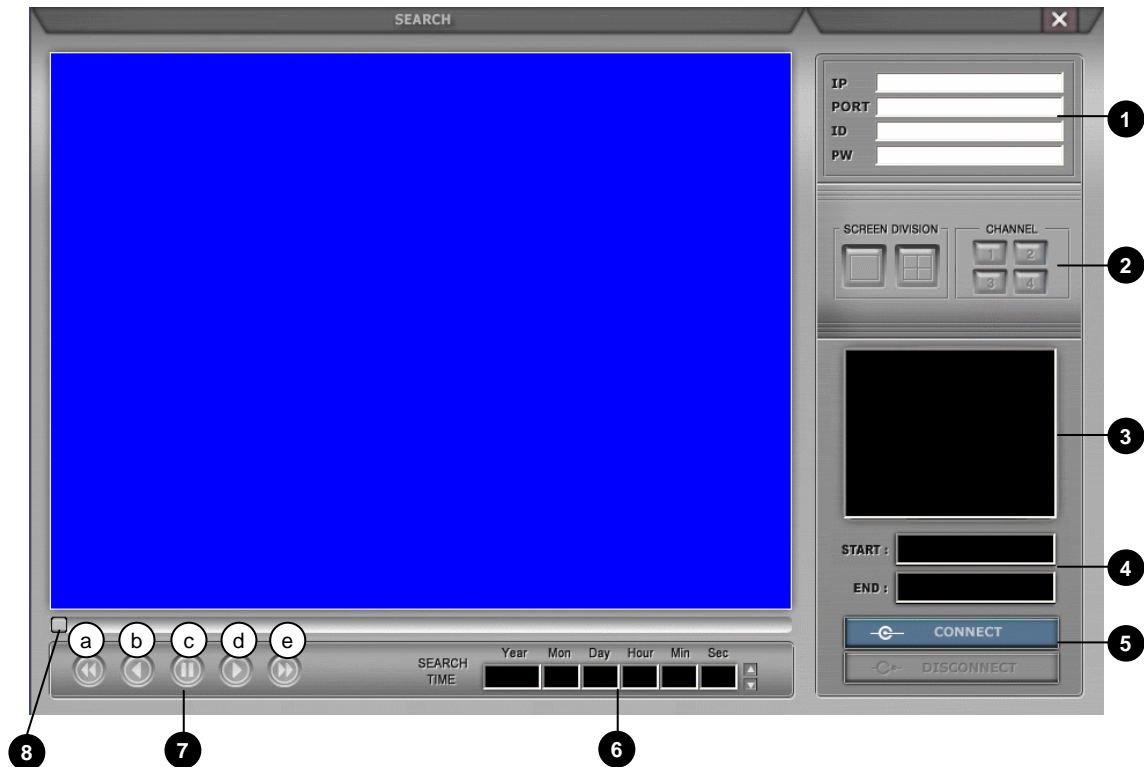

- ❶ **DVR connection setup** : Input network information to connect.
(IP / PORT / ID / PW)
- ❷ **Screen display**
 - a) SCREEN DIVISION : Selects full screen mode or 4-split mode
 - b) CHANNEL : Displays full screen for each channel.
- ❸ **System information** : Displays connection status and operating information.
- ❹ **Recorded data display** : Displays start time & end time of recorded data.
- ❺ **Network connection**
 - a) CONNECT : Click this button to connect to DVR & see live view over a network.
 - b) DISCONNECT : Click this button to disconnect.
- ❻ **Search time** : Input time and date to search images.
- ❼ **Operation buttons**
 - a) Fast backward playback
 - b) Backward playback
 - c) Pause
 - d) Forward playback
 - e) Fast forward playback
- ❽ **Search bar** : Enables to search recorded data by using this bar.

※ Interface and functions of Search are subject to change without prior notice.

6-5. Backup

1) To execute BACKUP, input IP Address & Port and click 'Connect Test' button.

The screenshot shows the 'Backup' configuration window with the following details:

- Backup Information:**
 - IP Address: 192.168.1.143
 - Network Port: 50000
 - User ID: admin
 - User Password: [Empty]
 - Save File Path: C:\W(3)CD\WX\Network_X_Ba
 - Start Backup Time: 0000/00/00 00:00:00
 - End Backup Time: 0000/00/00 00:00:00
- DVR Server Information:**
 - Recorded Start Time: [Empty]
 - Recorded End Time: [Empty]
 - Update button
- Backup Status:**
 - Message: [Empty]
 - Receive Rates: [Empty]
 - Backup Rates: [Empty]
 - Receive bps: [Empty]
 - Save Size: [Empty]
- Buttons:** Connect Test, Lock, Set Backup Time, Start Backup, Close.

2) After Connect Test is done, you can see 'Success Connect Test!' message. Then, click 'lock' button and click 'Set Backup Time' button.

The screenshot shows the 'Backup' configuration window after a successful connection test. The details are as follows:

- Backup Information:** (Same as previous screenshot)
- DVR Server Information:** (Same as previous screenshot)
- Backup Status:**
 - Message: Success Connect Test!
 - Receive Rates: [Empty]
 - Backup Rates: [Empty]
 - Receive bps: [Empty]
 - Save Size: [Empty]
- Buttons:** Connect Test, Lock, Set Backup Time, Start Backup, Close.

※ Interface and functions of Backup are subject to change without prior notice.

3) Now you set 'Start Backup Time', 'End Backup Time', 'Save File Path', 'File Size' and click 'Apply'.

The screenshot shows the 'Backup' configuration window with the following settings:

- Recorded Start Time:** 2007/05/09 14:10:28
- Recorded End Time:** 2007/05/10 19:31:21
- Save File Path:** C:\W(3)CD\X\Network_X_Backup
- Maximum Save File Size:** 10 MB
- Start Backup Time:** Year: 2007, Month: 5, Day: 9, Hour: 14, Minute: 10
- End Backup Time:** Year: 2007, Month: 5, Day: 10, Hour: 19, Minute: 31

Buttons visible: 'Apply', 'Close', 'Find', 'Update', 'Close'.

4) After finishing time setting, click 'Start Backup' to start backup. Then, you can see the backup file on the path that you chose.

The screenshot shows the 'Backup' configuration window with the following settings:

- Backup Information:**
 - IP Address: 192.168.1.19
 - Network Port: 50000
 - User ID: admin
 - User Password: [Empty]
 - Save File Path: C:\W(3)CD\X\Network_X_Backup
 - Start Backup Time: 0000/00/00 00:00:00
 - End Backup Time: 0000/00/00 00:00:00
- DVR Server Information:**
 - Recorded Start Time: 2007/05/09 14:10:28
 - Recorded End Time: 2007/05/10 19:31:34
- Backup Status:**
 - Message: Update Record Time !
 - Receive Rates: [Empty]
 - Backup Rates: [Empty]
 - Receive bps: [Empty]
 - Save Size: [Empty]

Buttons visible: 'Connect Test', 'Unlock', 'Set Backup Time', 'Start Backup', 'Update', 'Close'.

※ Interface and functions of Backup are subject to change without prior notice.

6-6. Player

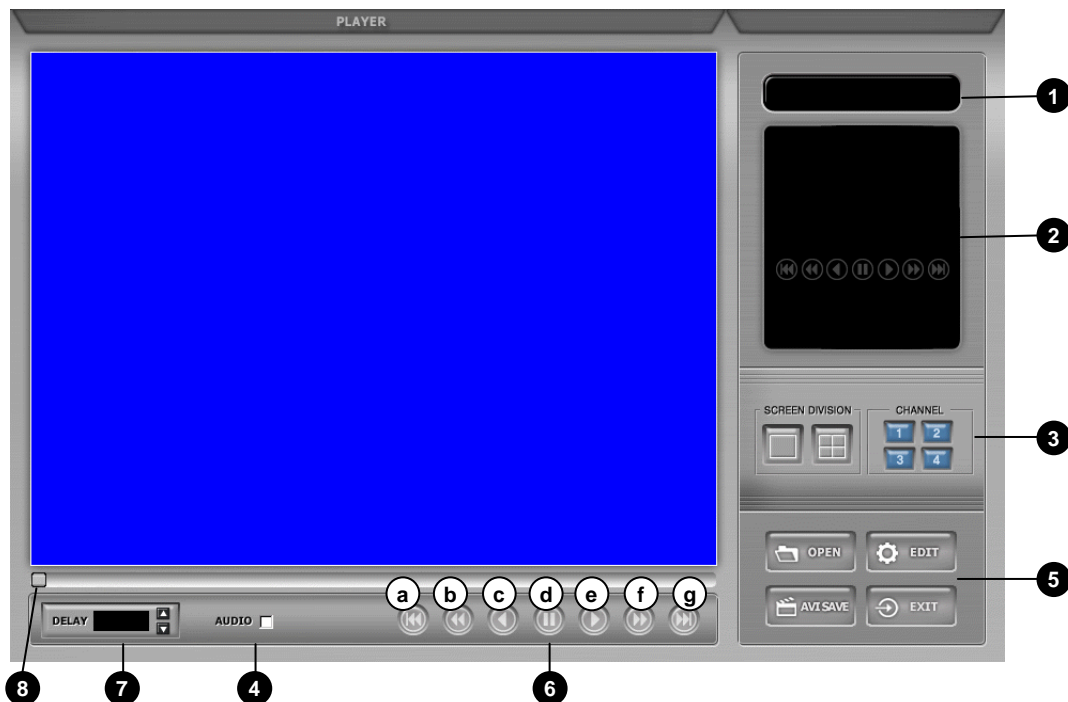

- 1 Time display : Displays current time.
- 2 Recorded data display : Displays start time & end time of recorded data.
Also, displays operating status during playback.
- 3 Screen display
 - a) SCREEN DIVISION : Selects full screen mode or 4-split mode
 - b) CHANNEL : Displays full screen for each channel.
- 4 Audio : set Audio ON/OFF
- 5 Operation buttons I
 - a) OPEN : Selects backup AM4 file.
 - b) EDIT : Enables to edit backup image, save and print.
*Edit function is available when one channel is selected.
 - d) AVI SAVE : Save backup images in AVI file format.
**AVI save function is available when one channel is selected.
 - c) EXIT : Ends backup player.
- 6 Operation buttons II: Search for recorded data.
 - a) Go to the beginning of recorded data and play.
 - b) Fast backward playback
 - c) Backward playback
 - d) Pause
 - e) Forward playback
 - f) Fast forward playback
 - g) Go to the end of recorded data and play.
- 7 Playback speed setting button : Able to adjust playback speed by using upper/ lower buttons.
DELAY : Adjusts playback interval. The higher, the slower. (1, 2, 4, 8, 16, 32)
- 8 Play bar : Enables to search recorded data by using this bar.

※ Interface and functions of Player are subject to change without prior notice.

Image EDIT

Click "EDIT" to go to image edit mode.



1 EDIT TOOL : User can adjust color tone of copied images using this buttons.

- Contrast

 : make bright part of image brighter and dark part of image darker

 : To reduce light and shade, lower contrast a little.

- Brightness

 : make an image brighter

 : make an image darker

- Sharpness

 : gives sharp-edge effect

- Blur

 : make an image soft

- Operation buttons

 : saves data in JPEG file format.

It is saved in the folder where player is installed. ('C:\WEB_BACKUP')

 : User can print current image selected.

2 EDIT : Return to player mode.

※ Interface and functions of Edit are subject to change without prior notice.

AVI SAVE

Click “AVI SAVE” to go to AVI saving mode.



- 1** **OPTION** : Used to save data in AVI file format.
 - CHANNEL : Selects channel
 - FRAMERATE : Decides frames per second of data to be saved.
 - SIZE : Decides the size of data to be saved automatically.
 - START : Starts saving
 - STOP : Stops saving. Once it is stopped, 'C:\WWEB_BACKUP' folder is opened automatically.
- 2** **AVI SAVE** : Opens 'Option' setting to start AVI saving.
 Closes 'Option' setting after finishing AVI saving and go back to player mode.

※ Interface and functions of AVI SAVE are subject to change without prior notice.

CHAP 7. DDNS Web-server

7-1. Registering DVR for DDNS (DDNS Web-server)

1) Please access www.h264ip.com and click Register Member ID.

Member Login

This website was created to provide a dynamic domain name system (DDNS) that allows DVR Systems to operate without a static IP from an Internet provider. This has been created exclusively for use with the Argus line of products. Complete the registration process to add your DVR to the system and enjoy the many benefits of DDNS.

Member ID:
 Password:

[Forgot Password](#)

Member Register > New user

* ID and Password must be three characters or more
 * We use User Email address to send information (User ID and Password) about your account.

Member Id:
 User Email:
 User Password:
 Confirm Password:

2) Please click 'DVR Add' or 'MY DVR Register' to register DVR.

DDNS service
DYNAMIC DOMAIN NAME SYSTEM

[Home] [Logout] [Member Edit]

Welcome web

Member

- Member Register
- My DVR List
- My DVR Register**
- DVR Setup
- Viewer
- Search
- Backup
- Player

My DVR List

* Click Viewer icon on the right to operate Viewer.
 * You should add www.h264ip.com on Trusted Sites (Tools -> Internet Options -> Security) at the first Viewer installation.
 * : DVR Setup : Viewer : Search : Backup : Player : DVR Edit : DVR Delete

DVR Name:

Name	MAC	IP:Port	Last Modified	Tool	Edit
Wallmart_XAD	00-0A-A2-06-D3-65	210.126.14.153:50000	2007-05-22 11:52:05		

※ Interface and functions of DDNS service are subject to change without prior notice.

3) Please click confirm after inputting DVR information (DVR Name and MAC Address only). Then, Click "Confirm" button.

My DVR Register

* Mac Address should be listed correctly without dash "-".
 * Mac Address already listed can not be registered again.

DVR Name	<input type="text" value="superman"/>
MAC Address	<input type="text" value="000AA200F00C"/> * without dash "-"
IP Address	<input type="text"/>
IP Port	<input type="text"/>
<input type="button" value="Confirm"/>	

4) Now, DVR is listed on DDNS web server without IP and Port number.

DDNS service
DYNAMIC DOMAIN NAME SYSTEM

[Home] [Logout] [Member Edit]

Welcome web

Member

- Member Register
- My DVR List
- My DVR Register
- DVR Setup
- Viewer
- Search
- Backup
- Player

My DVR List

* Click Viewer icon on the right to operate Viewer.
 * You should add www.h264ip.com on Trusted Sites(Tools -> Internet Options -> Security) at the first Viewer installation.
 * : DVR Setup : Viewer : Search : Backup : Player : DVR Edit : DVR Delete

DVR Name DVR Add

Name	MAC	IP:Port	Last Modified	Tool	Edit
Wallmart_XAD	00-0A-A2-06-D3-65	210.126.14.153: 50000	2007-05-22 11:52:05		

※ Interface and functions of DDNS service are subject to change without prior notice.

7-2. DDNS set up in DVR

* The following setting is a sample for a cable modem connected to DVR directly.

- 1) Go to Menu
- 2) Go to IP SETUP menu, if you set DHCP AUTOMATIC then it detects IP address automatically.

IP SETUP	
MAC ADDRESS	00-0A-A2-00-00-00
DHCP MODE	AUTOMATIC
IP PORT	50000
IP ADDRESS	192 168 001 160
GATEWAY	192 168 001 001
SUBNET	255 255 255 000
	DEFAULT ESC

- 3) Go to the previous menu and click DDNS SETUP.

TCP/IP SETUP	
IP SETUP	
DDNS SETUP	
CONNECTION SETUP	
	ESC

4) Set DDNS ON/OFF 'ON'.

IP address which is assigned from DHCP server is automatically input on DNS SERVER.

```

DDNS SETUP

DDNS ENABLE                ON
DNS SERVER                 168.126.063.001
INTERVAL                   D-00 H-00 M-20
                           REGISTER

DDNS STATUS                REGISTER OK
IP ADDRESS                 192.168.001.160
IP PORT                    50000
REMAIN TIME                D-00 H-00 M-20
LAST REGISTRATION DATE
> WED. 12 JUL 2006 09 : 21 : 36 GMT

ESC

```

5) Go down to REGISTER and push ENTER button to renew IP registered on DDNS SERVER.

(Interval : connection interval time between DVR and DDNS SERVER)

D = Day, H = Hour, M = Minute

```

DDNS SETUP

DDNS ENABLE                ON
DNS SERVER                 168.126.063.001
INTERVAL                   D-00 H-00 M-20
                           REGISTER

DDNS STATUS                REGISTER OK
IP ADDRESS                 192.168.001.160
IP PORT                    50000
REMAIN TIME                D-00 H-00 M-20
LAST REGISTRATION DATE
> WED. 12 JUL 2006 09 : 21 : 36 GMT

SUCCESS TO REGISTER DVR INFO

ESC

```

<DDNS status messages>

<DDNS error messages>

FAIL TO COMMUNICATE WITH DDNS SERVER :

(In this case, check out whether DNS server IP address is 168.126.063.001. If the IP address is same, please try another DNS server IP address provided by your ISP.)

FAIL TO REGISTER DVR INFO :

(In this case, please check out whether you registered your DVR in www.h264ip.com. And also check out your MAC address in your DVR is same as the one that has been registered in www.h264ip.com.)

6) Go to your computer again after you see “SUCCESS TO REGISTER DVR INFO” and then Click ‘refresh’ button. Then, DDNS server automatically catches your DVR’s IP address and Port number.

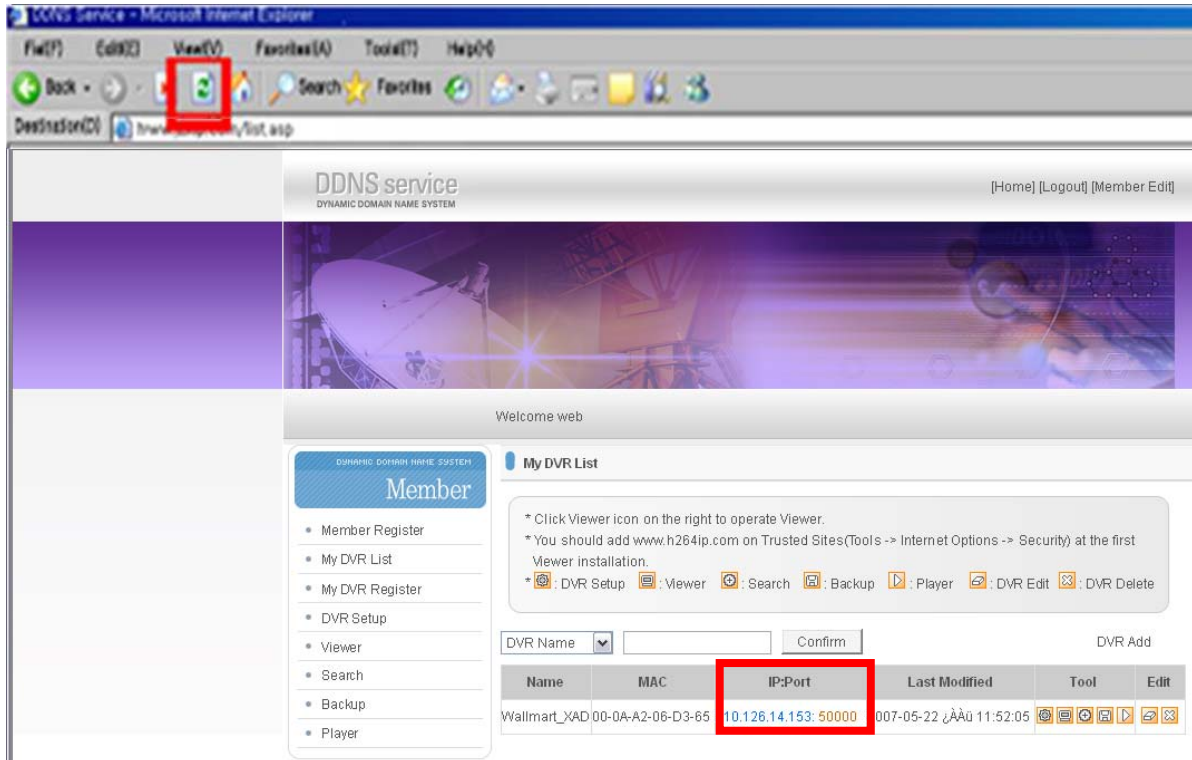

Note.

Before using Web-Viewer, please add www.h264ip.com on Trusted Sites at first installation as follows. (Tools -> Internet Options -> Security)

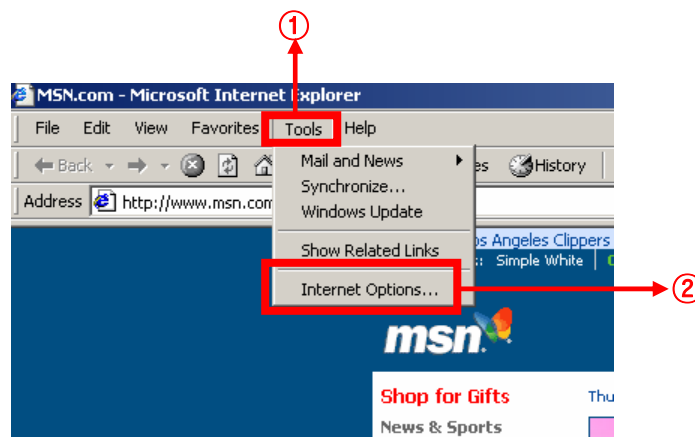

※ Interface and functions of DDNS service are subject to change without prior notice.

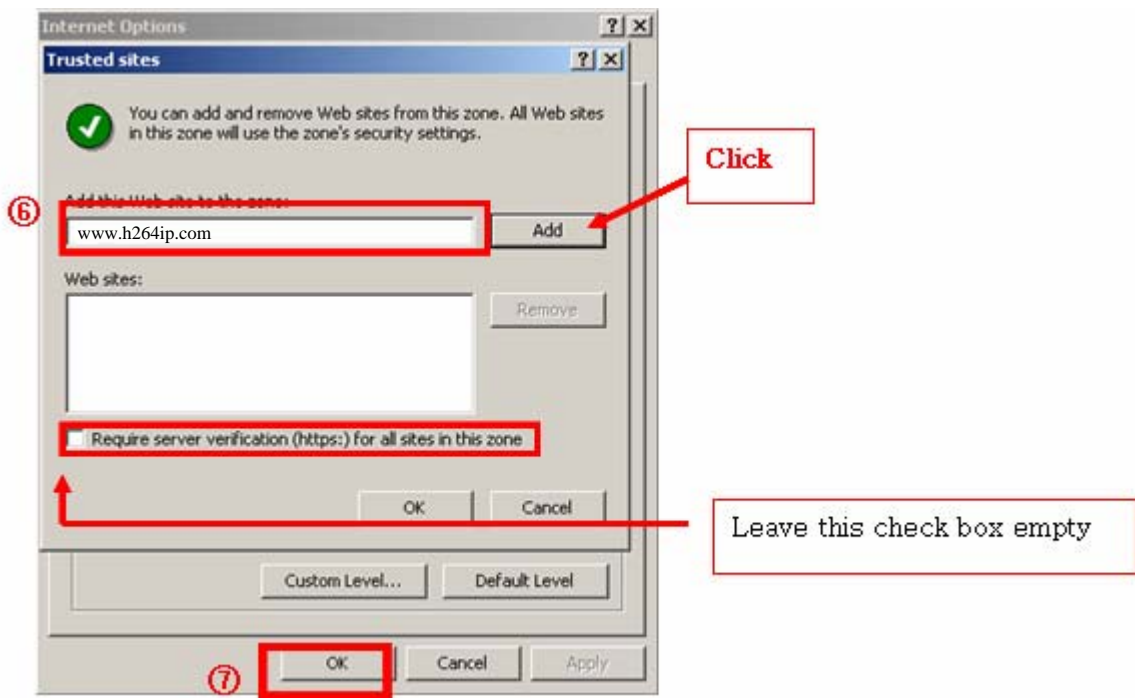
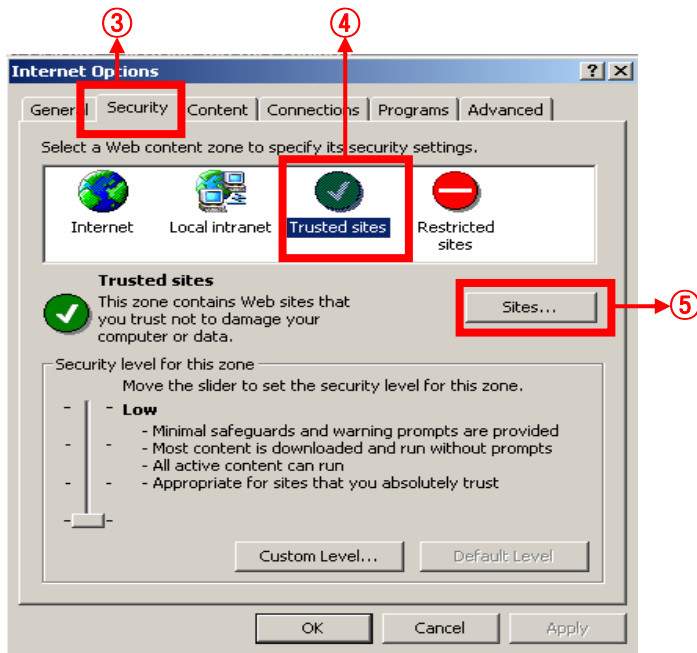

7-3. Web program

Some functions of IRS (Integrated Remote Station) such as Viewer, Search, Backup and Player are also available on the web.

*If ActiveX control installation is required for the first time access, please click 'Yes'.

Click and input information needed for internet connection to DVR manually.

Click these icons, then it connects to DVR automatically via DDNS server.

The screenshot shows the 'My DVR List' page. On the left, a navigation menu lists: Member Register, My DVR List, My DVR Register, **DVR Setup**, Viewer, Search, Backup, and Player. The 'DVR Setup' item is highlighted with a red dashed box. The main content area contains instructions: '* Click Viewer icon on the right to operate Viewer.', '* You should add www.h264ip.com on Trusted Sites(Tools -> Internet Options -> Security) at the first Viewer installation.', and '* [DVR Setup icon] : DVR Setup [Viewer icon] : Viewer [Search icon] : Search [Backup icon] : Backup [Player icon] : Player [DVR Edit icon] : DVR Edit [DVR Delete icon] : DVR Delete'. Below this is a 'DVR Add' form with a 'DVR Name' dropdown, an input field, and a 'Confirm' button. At the bottom, a table lists DVRs:

Name	MAC	IP:Port	Last Modified	Tool	Edit
Wallmart_XAD	00-0A-A2-06-D3-65	210.126.14.153:50000	2007-05-22 11:52:05	[DVR Setup icon] [Viewer icon] [Search icon] [Backup icon] [Player icon] [DVR Edit icon] [DVR Delete icon]	[DVR Edit icon] [DVR Delete icon]

The 'Tool' column icons are highlighted with a red dashed box. A red arrow points from the 'DVR Setup' menu item to the 'DVR Add' form, and another red arrow points from the 'Tool' icons to the table.

These functions such as Viewer, Search, Backup and Player are same as the ones in IRS. (Please refer to 'Chap 7. IRS' section from page 47 to 51.)

- DVR Setup** Enables to setup DVR remotely.
- Viewer** Enables to show live image display.
- Search** Enables to search and show recorded image display.
- Backup** Enables to back up recorded images in DVR to your PC.
- Player** Enables to play the backup images on your PC. (AM4 file)

※ Interface and functions of DDNS service are subject to change without prior notice.

CHAP. 8 Specifications

- H.264 Hardware Codec
- Real time live display in all channels
- Triplex (Playback / Recording / Ethernet)
- Web monitoring
- Easy control by Mouse
- USB memory stick for data backup.
- Easy PTZ Camera (MOUSE)
- Password protection
- Multi-language support

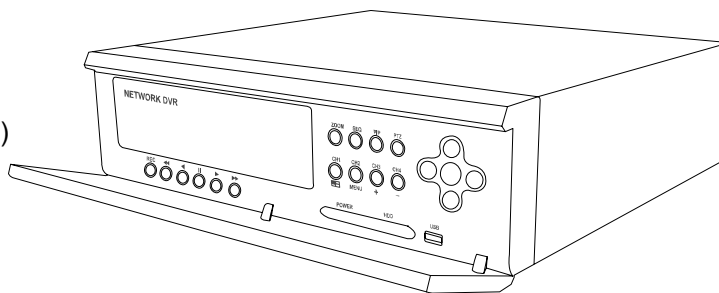

Multiplex function	Triplex (Playback / Recording / Ethernet)		
Storage Capacity	Internal	HDD	1 SATA HDD (no limit in capacity of HDD)
Video	Inputs		4Ch
	Output	Composite	2Ch (Monitor, SPOT)
	Compression		H.264 Hardware codec
	Compression Rate		5 step selectable
	Live Display Speed		Real Time Live Display
Recording / Search	Recording Mode		Schedule Record (Continuous/Motion/Alarm)
	Search		Event Search, Date/time Search, Percent Search
	Recording Speed (NTSC/PAL)		Max. 120FPS(NTSC) 100FPS(PAL)
	Recording Resolution		CIF (352x240/352x288)
Audio Recording	1 Ch Input / 1 Ch Output		
Language	English, Spanish, French, Italian, German, Russian, Japanese, Chinese To be added more		
Switching Interval	1~99 Sec selectable		
Live View Display	Full screen / 4-Split		
	Digital Zoom, PIP, Freeze, Sequence in live mode		
Alarm	Inputs	4 Alarm (NO/NC Selectable)	
	Outputs	1 (NO / NC)	
	Post Alarm	Alarm output duration : 2 ~ 99 Sec selectable	
Motion Area	30x24		
Network	Ethernet (TCP/IP)		
	Web Solution (DDNS) : DVR Setup, Viewer, Backup, Search		
Backup	USB Memory Stick / Download via IP Network		
PTZ Control	Via RS-485		
Firmware upgrade	Via USB		
Operation	P/S2 mouse, network		
Power Requirements	DC 12V 3.33A Adaptor		
Weight	2kg		
Dimensions (W x H x D) mm	280 X 260 X 80		

Design and specifications are subjected to change without notice.

CHAP. 9 Remote Controller

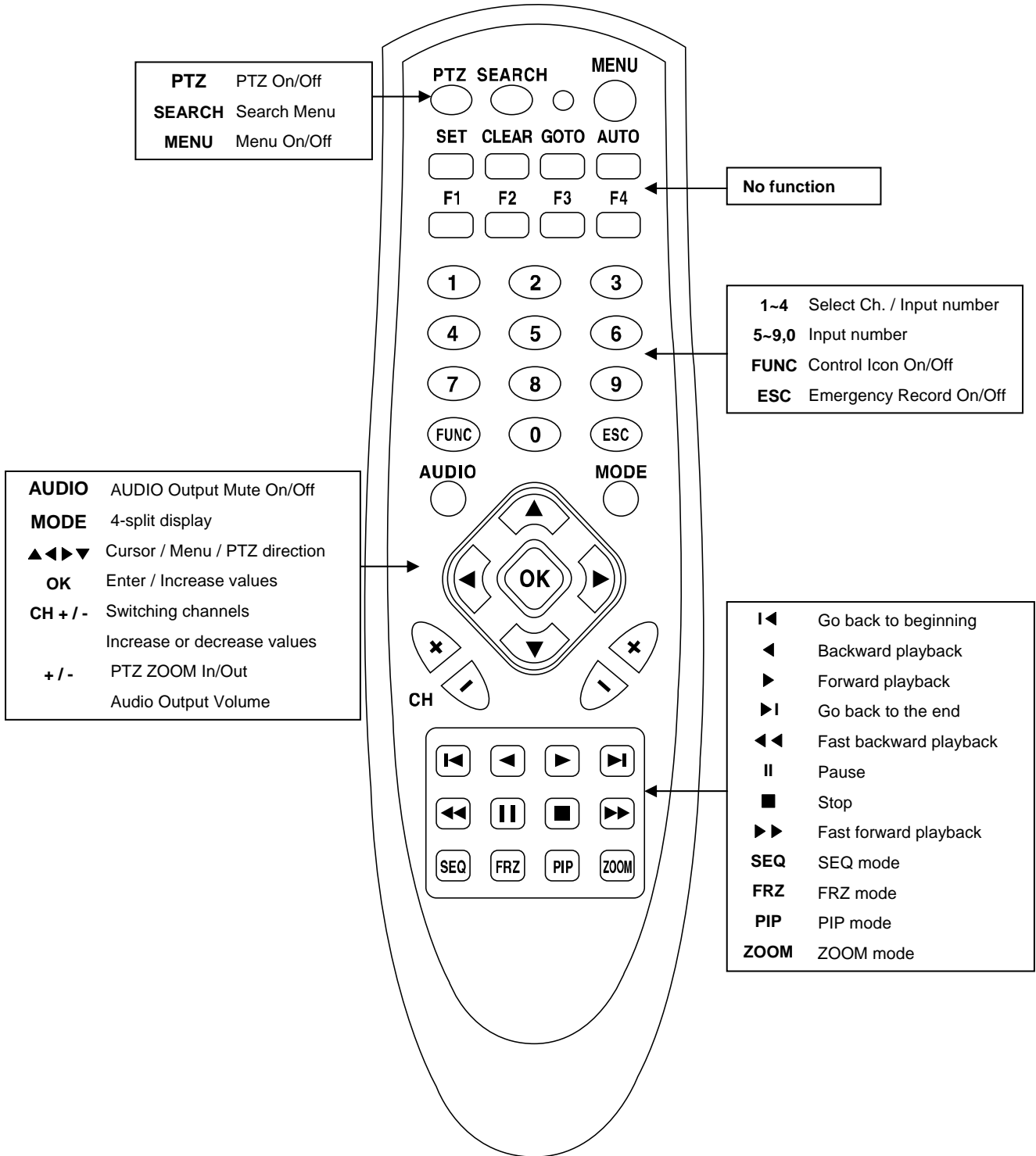

MEMO :

MEMO :

MEMO :

MEMO :



4Ch H.264 Hardware Codec – Network DVR