

H.264 Digital Video Recorder

8 and 16 Channel D1 recording at 30fps every individual channel

User's Manual VER 1.00

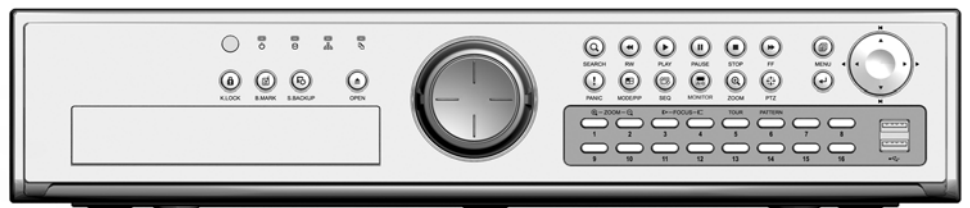

Future of Digital Video Recording at Hand

Table of Contents

| | |
|--|-----------|
| CHAPTER 1 PREFACE | 4 |
| 1. ABOUT THIS GUIDE | 4 |
| 2. SAFETY INFORMATION | 4 |
| CHAPTER 2 QUICK SETUP | 6 |
| 1. REAR PANEL CONNECTION (INPUT / OUTPUT) | 6 |
| 2. FRONT PANEL LAYOUT | 8 |
| 3. INITIAL SETUP | 9 |
| CHAPTER 3 HARDWARE CONFIGURATION | 12 |
| 1. PREPARATIONS FOR HARDWARE CONFIGURATION | 12 |
| 2. HARD DISK DRIVE AND OPTICAL DISK DRIVE MOUNTING | 13 |
| 3. RACK MOUNTING INSTRUCTION | 14 |
| 4. MONITOR CONNECTIONS | 14 |
| 5. CAMERA CONNECTIONS | 16 |
| 6. AUDIO CONNECTIONS | 16 |
| 7. ALARM/RELAY/INPUT-OUTPUT CONNECTIONS | 17 |
| 8. RS-232 CONNECTIONS | 18 |
| 9. RS-485 CONNECTIONS | 18 |
| 10. ETHERNET CONNECTION | 18 |
| 11. EXTERNAL S-ATA | 19 |
| 12. USB CONNECTIONS | 19 |
| 13. POWER CONNECTION | 19 |
| CHAPTER 4 FRONT PANEL KEY CONTROLS | 20 |
| 1. KEYS | 20 |
| 2. INDICATORS | 21 |
| 3. MOUSE CONTROL | 21 |
| 4. REMOTE CONTROL | 21 |
| CHAPTER 5 GRAPHICAL USER INTERFACE | 21 |
| 1. GENERAL GUI CONVENTION | 22 |
| 2. MONITORING POPUP MENU | 22 |
| CHAPTER 6 SYSTEM INFORMATION | 24 |
| 1. DVR SOFTWARE / HARDWARE VERSION INFORMATION | 24 |
| 2. SOFTWARE (FIRMWARE) UPDATE | 24 |
| 3. HARD DISK DRIVE INFORMATION | 25 |
| 4. HARD DISK DRIVE MANAGEMENT | 27 |
| 5. SYSTEM LOG | 28 |
| CHAPTER 7 USER SETTING | 28 |
| 1. TYPES OF USERS AVAILABLE | 28 |
| 2. CONFIGURING USERS IN USER AUTHORITY WINDOW | 29 |
| 3. TYPES OF USER AUTHORITY | 30 |
| CHAPTER 8 AUDIO / BUZZER | 30 |
| 1. AUDIO WINDOW | 30 |
| 2. BUZZER WINDOW | 31 |
| 3. LISTENING TO AUDIO IN LIVE VIEW | 31 |
| 4. LISTENING TO AUDIO IN SEARCH VIEW | 32 |

Table of Contents

| | |
|---|-----------|
| CHAPTER 9 IMPORT/EXPORT/RESET CONFIGURATION..... | 32 |
| 1. IMPORT AND EXPORT CONFIGURATION | 32 |
| 2. FACTORY DEFAULT CONFIGURATION..... | 33 |
| CHAPTER 10 DATE AND TIME | 34 |
| 1. CONFIGURING SYSTEM TIME MANUALLY | 34 |
| 2. DAYLIGHT SAVINGS TIME CONFIGURATION | 35 |
| 3. SYNCHRONIZED NETWORK TIME SETTING CONFIGURATION..... | 35 |
| CHAPTER 11 DISPLAY..... | 36 |
| 1. ON SCREEN DISPLAY | 36 |
| 2. VGA CONFIGURATION | 38 |
| 3. SPOT MONITOR SETTINGS AND OPERATION | 39 |
| 4. MANAGING INTERVAL TIME..... | 41 |
| 5. SWITCHING BETWEEN DISPLAY MODES | 41 |
| 6. CHANNEL LED INDICATOR..... | 42 |
| CHAPTER 12 CAMERA..... | 42 |
| 1. CAMERA SETUP | 42 |
| 2. CAMERA COLOR ADJUSTMENT | 43 |
| 3. PTZ CAMERA CONFIGURATION | 44 |
| 4. PTZ OPERATION..... | 46 |
| 5. MOTION SETUP..... | 47 |
| CHAPTER 13 EVENTS..... | 52 |
| 1. CONFIGURING ALARM INPUT | 52 |
| CHAPTER 14 RECORD..... | 52 |
| 1. RECORD SETUP:..... | 52 |
| 2. STANDARD RECORD SCHEDULE..... | 55 |
| 3. HOLIDAY SCHEDULE | 57 |
| 4. SEARCH & PLAYBACK | 58 |
| 5. EVENT SEARCH | 60 |
| 6. MOTION SEARCH | 62 |
| 7. BOOKMARK SEARCH | 64 |
| CHAPTER 15 DEVICE..... | 65 |
| 1. HDD CLEAR | 65 |
| 2. CD/DVD/USB BACK UP | 66 |
| 3. RS-232C..... | 68 |
| 4. KEYBOARD CONTROL (RS-485) | 69 |
| 5. REMOTE CONTROLLER..... | 70 |
| CHAPTER 16 NETWORK..... | 71 |
| 1. ETHERNET | 71 |
| 2. DDNS..... | 72 |
| 3. SERVER SETUP..... | 73 |
| 4. PPPoE..... | 74 |
| 5. NOTIFICATION | 75 |

CHAPTER 1. PREFACE

1. About This Guide

Convention Used in the Guide





Frontal Key Pad keys appear in brackets.

Example: [SEQ], [ZOOM], [SPOT], [PTZ] and [MENU]

Pages with additional information about specific topics are cross referenced. For example:
(See page xx.)

On screen buttons or menu items appear in bold.

Example: Click **OK** to enter.

| ICON KEY | |
|---|-----------------------|
|  | Note |
|  | Important Information |
|  | Mouse Operation |
|  | Stop. Do this first! |
|  | Critical Warning |

Icon Keys are indicated to mark important notes throughout the manual.

Note icon is provided to indicate additional notes that provide optional reference information for particular subject matter discussed throughout the manual.

Important information icon indicates special attention required or prerequisite required for certain subject matters discussed throughout the manual.

Mouse Operation Only icon is used for special operational items that are only accessible through mouse operation.

CHAPTER 1. PREFACE

2. Safety Information

The safety information is provided for the wellness of the equipment and for the safety of the operator. Please review and observe all instructions and warnings in this manual.



Note: Keep this manual handy every time you operate this equipment. Also check with your dealer if you require further assistance and for the latest revision of this manual. Your dealer might provide you with digital version of this manual. We ask to also keep original box and packing materials in case of return and for long term storage of the DVR unit.

Preparations before installation



To protect your DVR from damage and to optimize performance, be sure to keep the DVR away from dusty, humid, and area with high voltage equipment such as refrigerator.

Do not install or place equipment in areas where the air vents can be obstructed, such as in tight enclosures or small utility closet. Keeping the unit in temperature controlled room with ample regulated power is highly recommended. Do not overload the wall outlet as this can result in the risk of fire or electric shock.

Uninterruptible power devices such as UPS power surge protectors are recommended and at least the DVR units must be connected with UL, CUL or CSA approved power surge protector. Avoid direct sun light and avoid heat.

FCC Information



This equipment has been tested and found to comply with the limits of Class A digital device, pursuant to part 15 of the FCC Rules. These limits are designed to provide reasonable protection against harmful interference when the equipment is operated in a commercial environment. This equipment generates, uses, and can radiate radio frequency energy and, if not installed and used in accordance with the instruction manual, may cause harmful interference to radio communications. Operation of this equipment in a residential area is likely to cause harmful interference in which case the user will be required to correct the interference at his own expense. Changes or modifications not expressly approved by the party responsible for compliance could void the user's authority to operate the equipment under FCC rules.

cUL Information

- for pluggable equipment, the socket-outlet shall be install near the equipment and shall be easily accessible
- if the battery is placed elsewhere in the equipment, there shall be a marking close to the battery or statement in the servicing instructions.



CAUTION

RISK OF EXPLOSION IF BATTERY IS REPLACED BY AN INCORRECT TYPE.
DISPOSE OF USED BATTERIES ACCORDING TO THE INSTRUCTION.
THIS EQUIPMENT IS INDOOR USE AND ALL THE COMMUNICATION WIRING IS LIMITED TO INSIDE OF THE BUILDING, OR SIMILAR WORD.

CHAPTER

2

QUICK SETUP

Quick setup section illustrates all external connection scenarios and simple startup operation so the DVR unit could start recording valuable video evidence. However, it is recommended that you refer to this manual for detailed configuration and operation.

Please follow the instructions on this section for general setup procedures to make the unit operation. (Refer to **Figure 1 Real Panel connection**)

CHAPTER 2. QUICK SETUP

1. Rear Panel Connection (Input / Output)

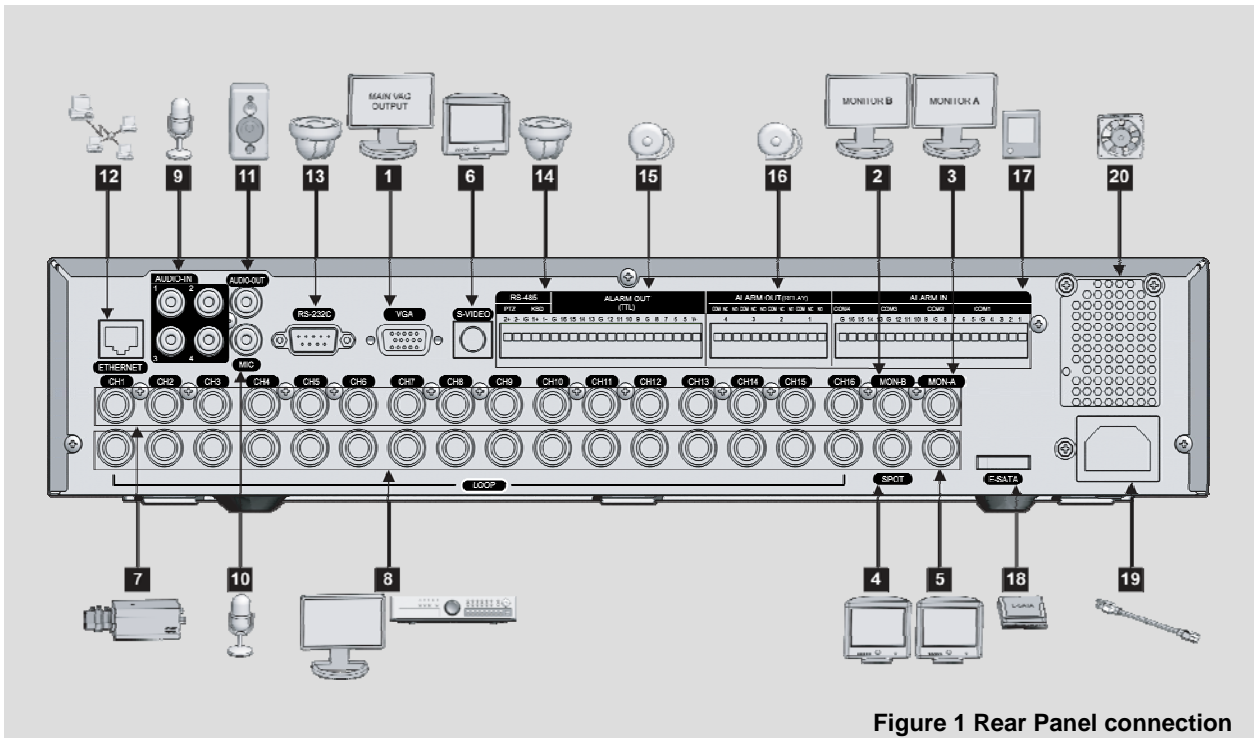

Figure 1 Rear Panel connection

Display output Connections

| | |
|---|--|
| 1 | Connect a CRT/LCD/Security Monitor <i>that</i> support VGA input. |
| 2 | Connect a display monitor that support BNC input, or you may use a BNC to Composite Video adapter. 'MON-B' can be used as an alternate display device. (Digital Spot out) |
| 3 | Connect a display monitor that supports BNC input, or you may use a BNC to Composite Video adapter. 'MON-A' can be used as an main display device which outputs the operational G.U.I (Graphical User Interface) |
| 4 | Connect a display monitor that support BNC input, or you may use a BNC to Composite Video Adapter. "SPOT" port is used for the "SPOT OUT" function of the system. The "SPOT OUT" function of the system |
| 5 | Not in Use at the moment. |
| 6 | Connect a display monitor that support BNC input, or you may use a BNC to Composite Video Adapter. The port is used as an alternate display device which outputs the operational G.U.I. (Graphic User Interface) |

Video Input / Output Connections

| | |
|----------|---|
| 7 | Connects the Cameras or Video Source (BNC Type) to these inputs. You may use BNC to Composite Video Adapter if necessary. |
| 8 | These video output ports (LOOP OUT) can be used to display each individual video input to a desired display device which support BNC input. You can use a BNC to Composite Video Adapter if necessary. Each LOOP OUT port will correspond to the same Video Input channel, e.g. "CH1" will output to LOOP OUT port 1, which is located right beneath "CH1". |

Audio Input / Output Connections

| | |
|-----------|--|
| 9 | Connect an Audio Capture device, such as a microphone to these inputs. |
| 10 | Connect a Microphone to this input. This port is solely used for the "2 Way Audio Communication" function with this system. The "2 Way Audio Communication" configuration is located in the main setup menu. |
| 11 | Connect an Audio Output device, such as a speaker system to this input. This port will output the chosen audio channel input as well as act as the output for the systems "2 Way Audio Communication" feature. |

External Device(s) Connection [COM/Data/Power/Sensor-Relay]

| | |
|-----------|--|
| 12 | Connect a Data Network Cable (RJ-45 type) to this input, "ETHERNET". Both your LAN / WAN functions use this port for remote connectivity. |
| 13 | There are 2 functions with this input (RS232). You can use a "RS485" to "RS232" adapter for PTZ data communication or this input can be used for an external controller. |
| 14 | Connect the PTZ data to this input, "RS485". Please refer both to your PTZ operational manual and our system operational manual for detailed instructions. |
| 15 | Connect an "Alarm Output Device", such as a door buzzer or speaker alarm to these outputs, "ALARM OUT". |
| 16 | Connect a "Relay Switch Device" to these outputs, "ALARM OUT". |
| 17 | Connect a "Alarm Sensor Device", such as a "Motion Sensor" to these inputs, "Alarm in". Please refer to our system operational manual for detailed instructions. |
| 18 | Connect an "External Storage Device" (External SATA format) to this output, "E-SATA". |
| 19 | Connect the power cable (provided with the system) to this input. |
| 20 | This is the heat exhaust fan. |



You can find detailed instruction for all features and ports later in this manual.

CHAPTER 2. QUICK SETUP

2. Front Panel Layout

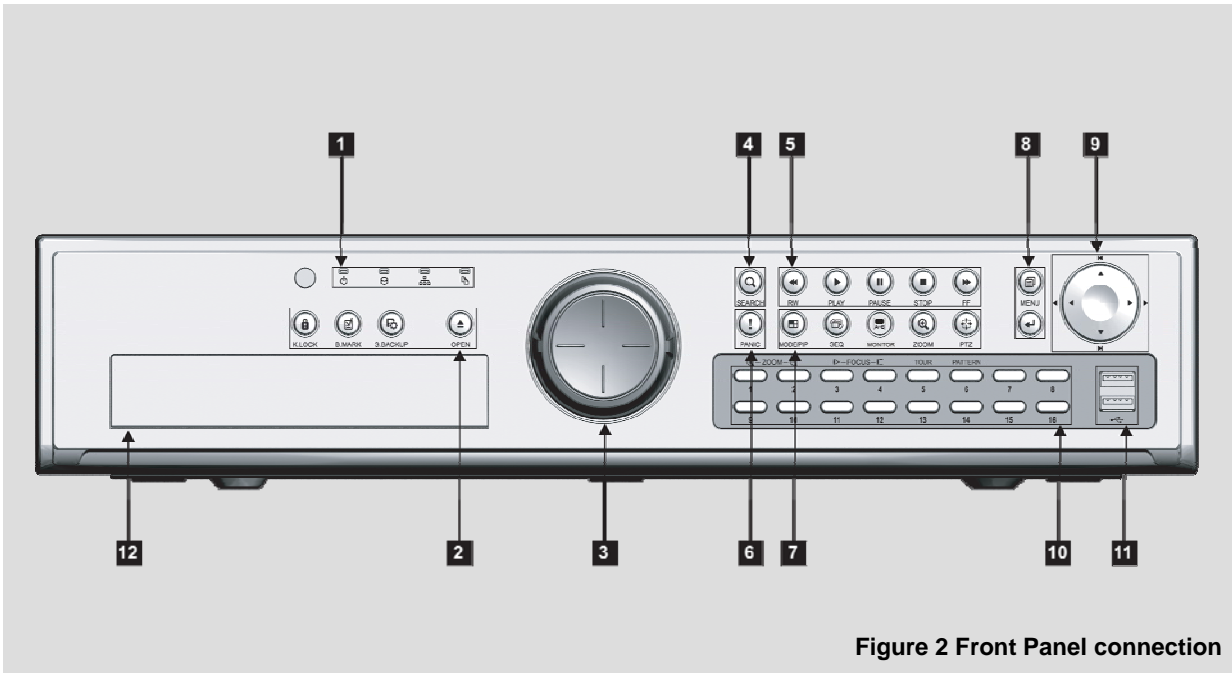

























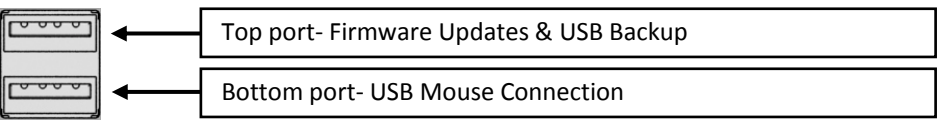

Figure 2 Front Panel connection

| | | |
|---|---|---|
| 1 |  | POWER LED INDICATOR This LED will illuminate when the system is powered on |
| |  | HARD DISK DRIVE LED INDICATOR This LED will illuminate when there is activity on the HDD |
| |  | NETWORK LED INDICATOR This LED will illuminate when there is a remote connection |
| |  | BACK UP LED INDICATOR This LED will illuminate when a back up is performed |
| 2 |  | KEY LOCK This button is used to lock the frontal keypad |
| |  | BOOK MARK This button is used during play back to bookmark a section of video. Please refer to the section Book Mark for more details |
| |  | SMART BACK UP This button is used to quick backup in AVI format |
| |  | OPEN This button is used to eject or close the DVD-R/CD-R Drive if installed |
| 3 |  | JOG SHUTTLE Used during playback to manipulate playback speed |
| 4 |  | SEARCH This button is used to initiate the search menu |
| 5 |  | REWIND Used during playback to rewind video |
| |  | PLAY Used to initiate playback |

| | | |
|-----------|---|--|
| |  | PAUSE Used during playback to pause the current video being played |
| |  | STOP Used during playback to stop current video being played |
| |  | FAST FORWARD Used during playback to fast forward video referring to panic record settings |
| 6 |  | PANIC This button is used to activate panic recording |
| 7 |  | MODE/PIP Used to change the live view screen division / enable picture in picture |
| |  | SEQUENCE Used to initiate video sequence mode |
| |  | MONITOR Used to select Monitor A/B controlled by front panel |
| |  | ZOOM Used to digitally zoom into live video |
| |  | PTZ Used to show the PTZ control |
| 8 |  | MENU Used to open the "Live View Menu" from the Live View Screen |
| |  | ENTER Used to confirm any action on the system |
| 9 |  | DIRECTIONAL KEYPAD Used to navigate through the various system menus |
| 10 |  | CHANNEL SELECTION This button is used to select a specific channel |
| 11 |  <p>USB Port There are two (2) USB ports on the front side key panel of the DVR. It is recommended to use the top port for Firmware Updates and USB backup, and the bottom port for the USB mouse connection.</p>  | |
| 12 | CD-R / DVD-R DRIVE BAY | |

CHAPTER 2. QUICK SETUP

3. Initial Setup

As all of the needed connections are made to the DVR unit, follow the instruction provided below to configure Date and Time, Camera, Recording and Network configuration

Before Powering Up

Make sure the unit is properly connected with Video Output Device, Cameras and protected by connecting to power surge protector.

Locate the area of where the unit will be placed. The area must be free from dust, direct sun light, moisture and must be well ventilated temperature controlled location.

Before connecting the power cord, ensure that power switch is set to "Off" position.

Power up the unit and do not interrupt the booting sequence. Make sure the unit is fully turned on before powering down.

First Initial Boot

Entering Setup Menu for First Time

Upon initial boot, unit will prompt you with initial boot message. Unit will check to see all the Hard Disk Drive is installed properly, Network Communication is functional and ready to operate, and upon completing initial system check it will display maximum allowed split screen of the live view.

Short beep will indicate that the unit is now ready for operation.

Press the [MENU] button on the frontal key pad to bring up the setup menu.

Default language for the unit is in English. If you need to change the language settings please check the User's Manual for details.

Navigation

Use the supplied USB mouse for easy operation. Alternatively, use the following frontal key pad or Remote Controller key pad.

Use the ↵ (ENTER) button to commit the highlighted selection.

Use the directional keys ▲▼◀▶ to move through a menu or list

Use [MENU] button to enter and exit menu or a window.

Main Menu Icons

Six main menu icons are SYSTEM, DISPLAY, CAMERA, RECORD, DEVICE and NETWORK.



You must first perform "Date and Time Setup", "HDD Clear", "Factory Default Procedure" and "Reboot" under following circumstances.

1. Operating the DVR unit for the first time.
2. After Hard Disk Drive upgrade.
3. Changing the system time or reconfiguring time zone setting.
4. After Firmware update.
5. After Time Server Configuration.

Date and Time Setup

Find the DISPLY icon in Main System Menu and select it.

Select appropriate time zone from the "Time Zone" drop down list.

Select appropriate display format from the "Display Format" drop down list.

Configure date and time format by using "Date / Time Format" drop down list.

Select appropriate year, month, date, hour, minute and second from the "Date / Time Setup" section.

Hard Disk Drive Clear

After performing date and time setup, follow below instruction to clear the Hard Disk Drive.

Locate DEVICE icon and select it

Select Hard Disk Clear drop down list.

Click on the **Start** button next to "HDD Clear" section.

Exit out of the main menu and reboot.

Record Configuration

Locate RECORD icon from main menu and select it.

On the Record Setup window, click on Normal button.

Choose the desired resolution and quality and frame rate by using the drop down list items. They are configurable by each channel or you may use the copy setting button to apply to all cameras.

Select the Schedule page by using the drop down list located near upper left corner.

On the Schedule page select the Mode Column to choose between Continue, Motion, Alarm, Motion+Continue(M+C), Alarm+Motion(A+M). (For quick setup purpose set it to Continue.)

Network Configuration

Locate the NETWORK icon and select it.

Select the Ethernet page by using the drop down list located near upper left corner.

Choose between Dynamic IP or Static IP radial button.

Dynamic IP Example

Choose the Dynamic IP Radial button.

On the "IP Detect" section click on the **Start** button and observe the IP address and other setting auto populated in to fields.

Static IP Example

Choose the Static IP Radial button.

Populate the field provided below with IP address, Subnet Mask, Gateway, DNS and Stream Port ID.

PPPoE Example

The PPPoE configuration is required if you are using the ADSL service provided by your ISP. It is very common type of the high speed Internet service provided by your service provider.

Select the PPPoE page by using the drop down list located near upper left corner

When PPPoE pager is shown you will be able to locate PPPoE radial option button that may be selected to be On or Off.

Input the ID provided by your Internet Service Provider in ID section of the page.

Input the password provided by your Internet Service Provider in password section of the page.

Keep the connection section at default setting unless specified differently by your Internet Service Provider.

Save the setting and exit the menu.

CHAPTER

3

HARDWARE CONFIGURATION

CHAPTER 3. HARDWARE CONFIGURATION

1. Preparation for Hardware Configuration

It is critical that you prepare the area where you will perform the hardware configuration. Your DVR unit may or may not have HDD, CDR or DVDR installed. In such case you must perform hardware configuration before unit is operational. You may also decide that the DVR unit will be installed in rack enclosure. This section also explains how to install rack mount bracket for equipment mounting.



You will need to have Phillips screw driver and area safe from Electro Static Discharge (ESD). You will be required to remove smaller size screws to open and close the case. Please be careful not to misplace the screws, they are oftentimes difficult to find at hardware stores.

Package Contents

| | |
|--|--|
| 1. Main DVR Unit | 2. Remote Controller |
| 3. Power Cable | 4. User's Manual and QSG |
| 5. Software CD | 6. Rubber foot pads (for desktop installation) |
| 7. Shoulder Screws | 8. Batteries for remote controller |
| 9. Rack Mount Screws and rack assembly kit | 10. Mouse |

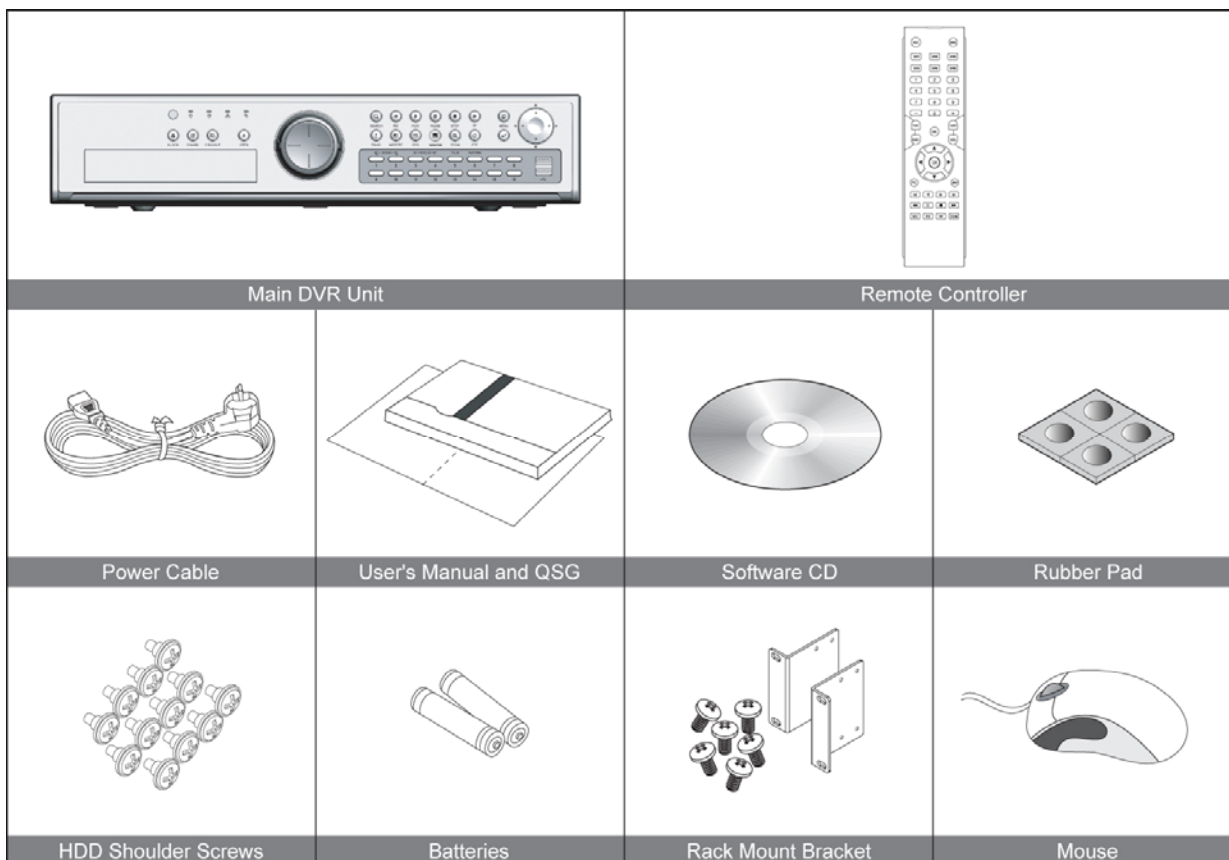

Figure 3

CHAPTER 3. HARDWARE CONFIGURATION

2. Hard Disk Drive and Optical Disk Drive Mounting

Up to four hard disk drives can be installed in the DVR. You must disassemble the top cover of the DVR to expose the unit as seen below diagram. The DVR uses Serial ATA hard disk drives.



Only the approved hard disk drives will work in the DVR unit. You may obtain the compatibility list from your dealer. Your dealer might perform the necessary upgrade for you. Consult your dealer for more details. Improper handling or installation could void the warranty of both the hard disk drive and the DVR. It is also strongly recommended to use same speed hard disk drive, and if possible match the model numbers of the hard disk drive to identical drives.



CAUTION! Electrostatic discharges (ESD)

Any electrostatic charge in contact with hard disk drives or other electronic components in the DVR unit can damage them permanently. Improper handling could void the warranty of the hard disk. When working with electrostatic sensitive devices such as a hard disk drive or the DVR unit, make sure you perform installation from static free workstation.

Mounting Instructions

Removing Top Cover

With proper removal of the top cover there will be main board of the DVR and SATA connectors that are available.

Locate the hard drive mounting bracket and install as shown below example in Figure 4 Hard Disk Drive Mounting Bracket.

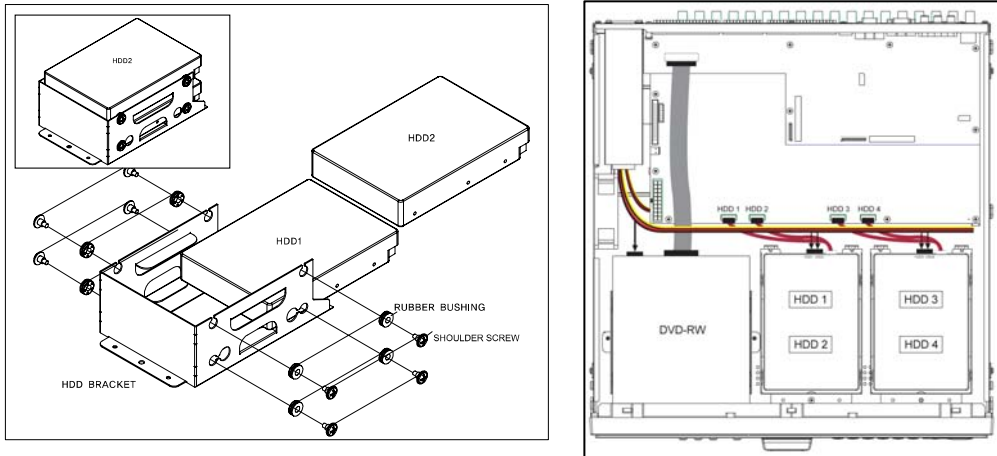

Figure 4 Hard Disk Drive Mounting Bracket



For the single Hard Disk Drive installation please locate the marked SATA 1 or Primary SATA cables and connector and install the HDD to it.



Upon completion of your hard disk drive installation, please perform following procedures. It is critical that you follow this procedure after hard disk installation to properly record video images to hard disk drives.

1. Perform the Hard Disk Clear procedure
2. Check to see if proper size is allocated
3. Perform factory reset procedure

CHAPTER 3. HARDWARE CONFIGURATION

3. Rack Mounting Instruction

The unit can be mounted in a 19-inch rack, rack enclosure or equipment cabinet. A rack mounting kit is supplied with the unit that includes two rack mounting brackets and sets of rack screws.

Rack mount bracket installation

- Step 1. Remove all 4 screws located on the side caps.
- Step 2. Attach rack mount bracket to DVR and use the screws from step 1.
- Step 3. Attach DVR to the rack mount enclosure

CHAPTER 3. HARDWARE CONFIGURATION

4. Monitor Connections

Monitor A (BNC Type)

Monitor A connection is the main monitor output for composite type monitor. This port is used as primary connection along with the VGA port. They may be used simultaneously along with VGA port.

Connect a monitor that supports BNC Inputs or use a “BNC Twist Lock” to Composite Video adapter if your monitor only supports Composite Video Inputs.
The display resolution for Monitor A is at 720x480.

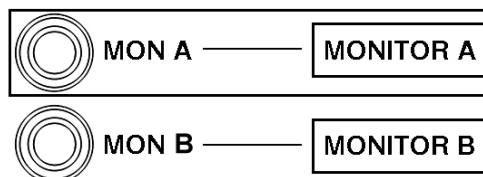

Figure 5-1 Monitor Connection

Monitor B (BNC Type)

Also known as Digital Spot Monitor connection, used as alternative video output for the purpose of public display, guard monitor, monitoring stations and other location where configuration or playback may not be needed. Because of these nature, Digital Spot Monitor connection is programmable where “Full” (Single Channel View) or “2X2” (Quad Display Mode) is supported. Addition to it, it also supports programming feature to schedule and to hide certain camera to display. As available to both digital and analogue Spot Monitor connection sequencing times are programmable as well.

Connect a secondary monitor that supports BNC Inputs or use a “BNC Twist Lock” to Composite Video adapter if your monitor only supports Composite Video Inputs.
The display resolution for Monitor B is at 720x480.

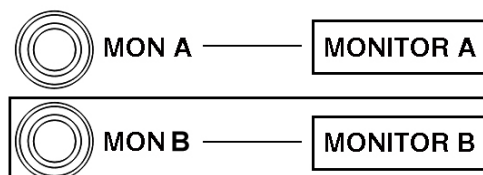

Figure 5-2 Monitor Connection

VGA (Video Graphics Array) Port

Becoming ever popular is the VGA availability and utilization of LCD Screen monitor. The DVR unit supports multiple array of VGA resolution and refresh rate available to popular LCD Monitor and High

Resolution HD LCD TV. Connect a VGA monitor to the DVR with a standard VGA Cable. We recommend using a 17" LCD or CRT monitor or above.

Supported resolutions for the VGA ports are:

- 640x480 @ 60Hz/75Hz
- 800x600 @ 60Hz/75Hz
- 1024x768 @ 60Hz/75Hz
- 1280x1024 @ 60Hz/75Hz

All resolutions display at True Color 32 Bit

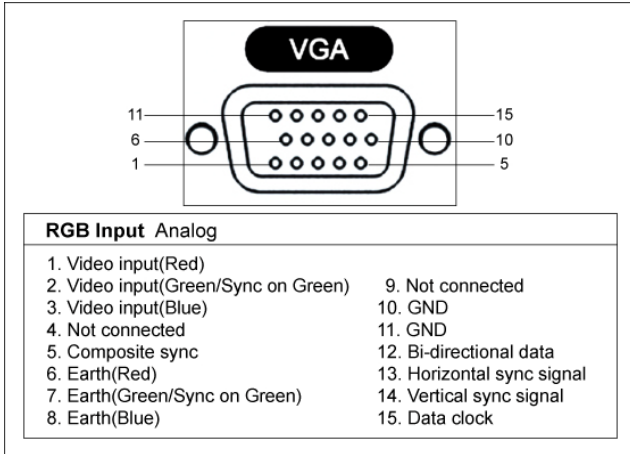

Figure 6 VGA Pin Description

Analog SPOT

The analog SPOT is a SPOT monitor output connection that provides single channel view in sequencing mode. Sequencing interval may be defined to regulate the channel switching time.

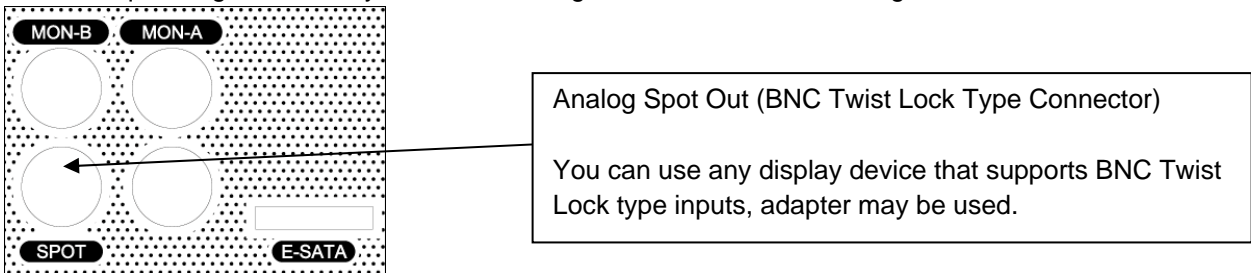

Figure 7-1



Check this before connecting monitor
 There is BNC connector that is not being used.
 It is reserved for later feature addition and currently not being used.
 Please locate a port below MON-A and right side of SPOT location.

This port will not show any video output. (See Figure 7-2 BNC Port not being used)

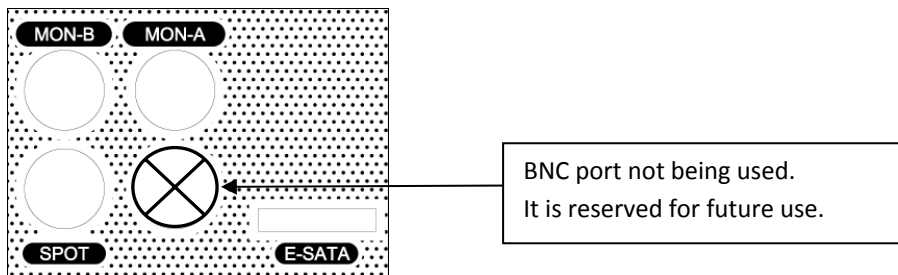

Figure 7-2 BNC Port not being used

CHAPTER 3. HARDWARE CONFIGURATION
5. Camera Connections

Connect the cameras to the Video In ports located on the rear panel of the DVR using the proper cables and connectors (BNC Twist Lock). The corresponding video channels can be “looped” out using the “loop out” ports located beneath each video input port. There is no need for terminators to be installed, each port is self terminated. Both NTSC and PAL signals are automatically detected by the DVR and requires no further configuration. Please refer to the figure below.

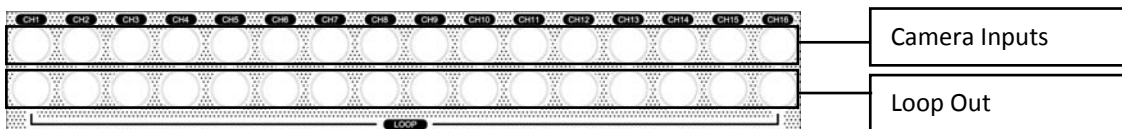

Figure 8 Camera input and loop out diagram

The loop out ports may be used to display the video signal from each individual channel to any desired display output device such as a monitor or it can be used to provide a video signal to another DVR system. The type of connection of the loop out ports use is BNC Twist Lock type.

Video Input Signals Specification

- 1 Vpp / 75 ohm
- PAL / NTSC Auto Detect
- BNC Inputs With Loop Out

CHAPTER 3. HARDWARE CONFIGURATION
6. Audio Connections

The audio connections of DVR are used for both recording and monitoring purposes. You have the option to disable both audio recording and monitoring functions in the “Audio Setup Menu”.

Both 8 and 16 channel models support up to 4 audio input channels and 1 audio output channel, as well as 1 port for microphone input. Connect using RCA/Composite audio compatible cables with compatible RCA/Composite audio connectors.

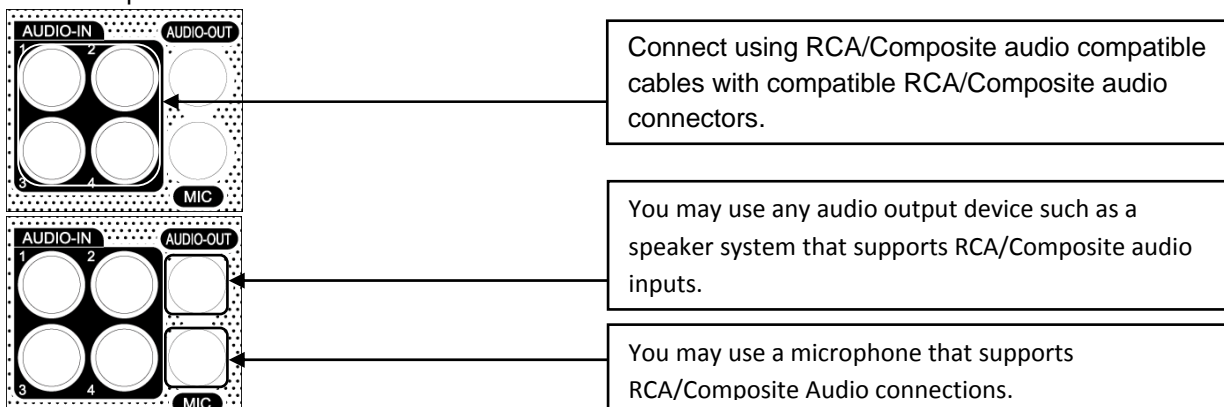

Figure 9 Audio Input / Output and Microphone Connection example

| | | |
|-----------------------|---------------|--------------------------|
| Specifications | Input Signal | Mono RCA, 1Vpp, 10 k ohm |
| | Output Signal | Mono RCA, 1Vpp, 10 k ohm |

CHAPTER 3. HARDWARE CONFIGURATION

7. Alarm/Relay/Input-Output Connections

Alarm inputs and outputs are supplied via the switch panel located on the rear of the DVR. The switch terminal simplifies the use of various sensors and relays with our DVR.

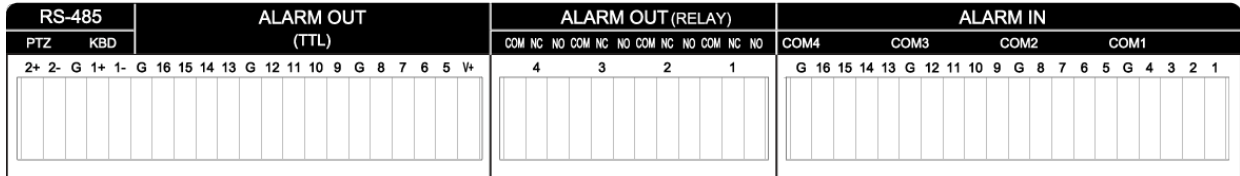

Connecting the Inputs:

Each alarm input can be controlled/switched by a device such as a motion/IR sensor, door contact sensor, and similar devices. Each device can either be wired as N/O or N/C (Normally Open/Normally Closed). This can be configured in the "Alarm" menu as N/O or N/C as well.

| | | |
|-----------------------|---------------------|-----------------------------------|
| Specifications | Alarm Input | 10K to +5v |
| | Input Voltage Range | 5VDC (minimum) to 40VDC (maximum) |

[Alarm In]

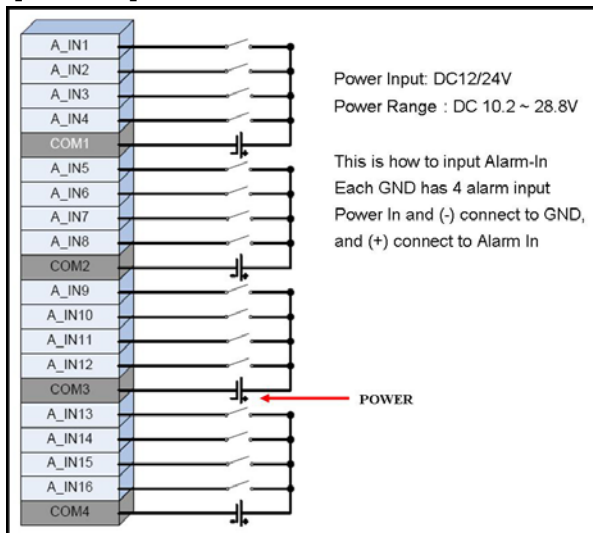

[Alarm Out_Relay]

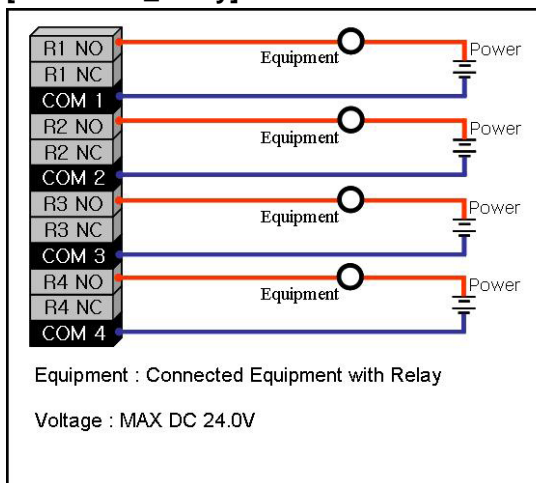

[Alarm Out_TTL]

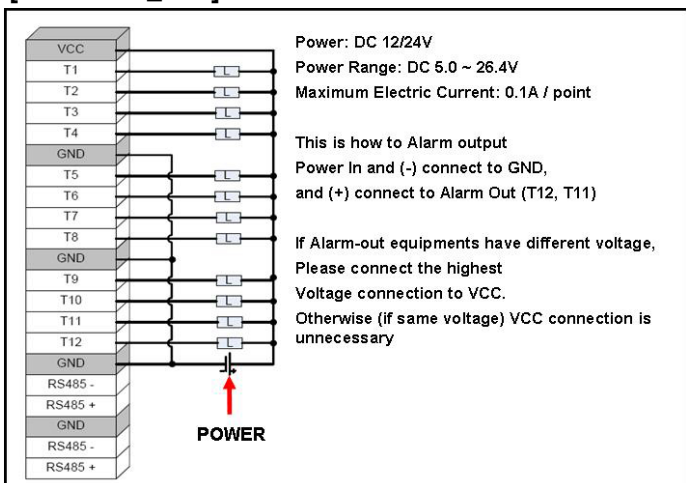

CHAPTER 3. HARDWARE CONFIGURATION

8. RS-232 Connections

The RS-232 COM port is used to connect the DVR to a PC (optional updating procedure) or to connect an external device like a DVR controller (optional). The required settings to use the RS-232 port can be configured in the DVR settings.

| | | |
|-----------------------|-----------------------|------------------------------|
| Specifications | Connection Type | 9 pole D-Type male connector |
| | Maximum Input Voltage | +/- 25V |

| Signal Type | Pin Number | Description |
|-------------|------------|-------------------------------------|
| DCD In | 1 | Carrier Detection Signal (not used) |
| Rx | 2 | RS232 Receive |
| Tx | 3 | RS232 Transmit |
| N/C | 4 | No Connection |
| GND | 5 | System Ground |
| N/C | 6 | No Connection |
| RTS | 7 | RS232 Request To Send Signal |
| CTS | 8 | RS232 Clear To Send Signal |
| N/C | | No Connection |

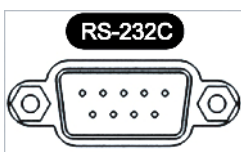

Figure 10 RS-232 Port

CHAPTER 3. HARDWARE CONFIGURATION

9. RS-485 Connections

The RS-485 ports are used to connect external PTZ cameras to the DVR. There are two available ports with this DVR. External controllers may be used, however you will not have the ability to control the PTZ cameras remotely if you do so. There are two RS-485 communications ports, these ports are used to connect external PTZ camera controllers.

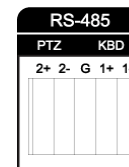

Figure 11 RS-485 Connection

CHAPTER 3. HARDWARE CONFIGURATION

10. Ethernet Connections

The RJ-45 port is used to connect the DVR to a network through a DTE (Data Terminal Equipment) device such as a switch or router with an integrated switch. To connect the system to a network please use a standard RJ-45 cable (patch/straight through) and make sure both ends of the cable are securely connected to the proper ports. Consult your local IT administrator for detailed configuration procedures and setup. The maximum cable length for Category 5e, RJ-45 cable is 100 meter or 300 feet.

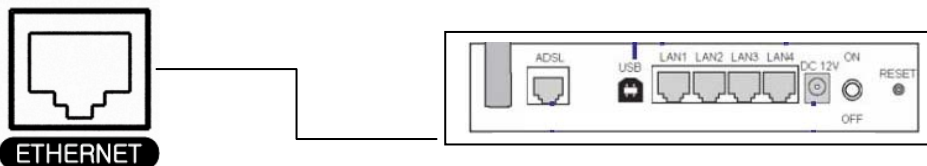

Figure 12 Ethernet Connection Example

| | | |
|-----------------------|-----------------------|---|
| Specifications | Connection | 10/100 Base T, IEEE 802.3Differential signal voltage: ± 2.8 V maximum, inputs have transient overvoltage protection |
| | Ethernet port details | EEE 802.3/802.3u - 100Base-TX/10Base-T physical layer |
| | Auto negotiation | 10/100, full/half duplex |
| | Cable length | 100 meters (100 ohm unshielded twisted pair cable or 150 ohm shielded twisted pair cable, category 5 or higher). |
| | Impedance | built-in compensation for impedance matching |
| | Indicators | ACT, 10/100 |

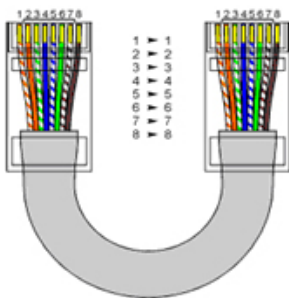

Figure 13 CAT 5 cable color code for EIA/TIA E568B Configuration

| Signal Type | Pin Number | Description |
|-------------|------------|----------------------------|
| LAN Tx + | 1 | Ethernet Transmit Positive |
| LAN Tx - | 2 | Ethernet Transmit Negative |
| LAN Rx + | 3 | Ethernet Receive Positive |
| N/U | 4 | Not Used |
| N/U | 5 | Not Used |
| LAN Rx - | 6 | Ethernet Receive Negative |
| N/U | 7 | Not Used |
| N/U | 8 | Not Used |

CHAPTER 3. HARDWARE CONFIGURATION

11. External S-ATA

The external S-ATA port is used to connect external storage devices that support S-ATA format



Figure 14 E-SATA Connection

CHAPTER 3. HARDWARE CONFIGURATION

12. USB Connections

The USB connection ports are used for both back up and mouse control purposes. Either port can be used for back up via USB memory stick or for mouse control. A third option for the two USB ports are for firmware updating procedures. You will only need to use one port for firmware updates.

Two USB ports are located on the front side of the DVR. These ports may be used for both USB mouse connection and for USB memory stick back up procedures. There are two (2) USB ports on the front side key panel of the DVR. It is recommended to use the top port for Firmware Updates and USB backup, and the bottom port for the USB mouse connection.

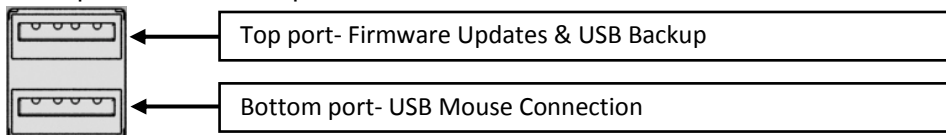

Figure 15 USB Connector Port

CHAPTER 3. HARDWARE CONFIGURATION

13. Power Connections

The power is supplied to the DVR by an internal power supply unit, and can be either switched on or off by the toggle switch located on the rear panel of the system.

| Specifications | Input Voltage | 100 - 240 VAC ±10% |
|----------------|-----------------|--------------------|
| | Current | 4A - 2A |
| | Input Frequency | 50/60 Hz |



WARNING!

This is a live electrical outlet. risk of electrical shock. do not attempt to open the cover of the DVR or the power supply unit. Contact your local service center for repair. Warranty is void if the system is improperly handled

CHAPTER

4

FRONT PANEL KEY CONTROLS

Front side section of the DVR unit holds LED Indicators, controllable key buttons, Jog-Shuttle control, IR sensors and USB connectors

CHAPTER4. FRONT PANEL KEY CONTROLS

1. Keys

The keys on the front panel are used to control all functions of the DVR. Symbols will be located near each key to represent its function.

Directional Key Pad –

The directional key pad is used to navigate through the system menus of the DVR. These keys can navigate up and down menu settings as well as change specific values in each system menu option. You may also use the directional key pad during playback to engage reverse playback, forward playback, or frame by frame play back.

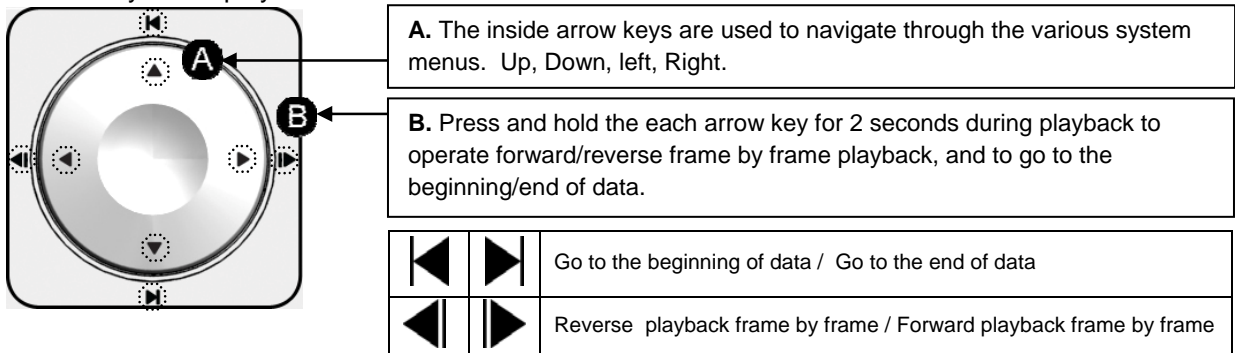

























Figure 16 Directional Key Pad

| | |
|---|---|
|  K.LOCK | Key Lock: Disables the ability to use all frontal keys |
|  B.MARK | Book Mark: Used during playback to mark a desired point of the video |
|  S.BACKUP | Smart Back Up: This button is used for quick AVI backup. |
|  OPEN | Open: Used to eject and close the DVDRW or CDRW Drive. |
|  SEARCH | Search: Used to display the main search menu. |
|  RW | Rewind: Used during playback to rewind video (1x to 1/16x). |
|  PLAY | Play: Used to playback the most recent recorded video. |
|  PAUSE | Pause: Used to pause the current video being played back. |
|  STOP | Stop: Used to stop the current playback, and exit to live view mode. |
|  FF | Fast Forward: Used during playback to increase playback speed (1x to 16x). |
|  MENU | Menu: Used to access the main system menu. |
|  PANIC | Panic: Used to engage panic mode recording (configurable from sys. menu). |

| | |
|---|--|
|  | Mode/PIP: Used to change the current live view screen division, and enable picture in picture mode. |
|  | Sequence: Used to engage video sequence mode in single channel view. |
|  | Monitor: Used to select Monitor A/B controlled by front panel |
|  | Zoom: Used to enable digital zoom during live view (up to x128) |
|  | PTZ: Used to display the PTZ control menu. |
|  | Enter: Used to enter a chosen menu, and to confirm changed settings. |

CHAPTER4. FRONT PANEL KEY CONTROLS

2. Indicators

| | |
|---|--|
|  | IR Receiver: The infrared receive for the remote controller. |
|  | Power LED: Power indicator, this LED will illuminate when the power is on. |
|  | HDD LED: Hard Drive indicator, this LED will illuminate when there is hard drive activity. |
|  | Network LED: Network indicator, This LED will illuminate when there is a remote connection |
|  | Back Up LED: Back up indicator, this LED will illuminate when a back up is being performed. |

CHAPTER4. FRONT PANEL KEY CONTROLS

3. Mouse Control

All controls located on the frontal keypad of the DVR may also be controlled via a USB mouse (included). To display and/or access the main menu, you can “right click” the mouse anywhere on the live view screen. Once you right click the mouse on the live view screen, a pop-up menu will appear. You can now access all menus of the DVR.

CHAPTER4. FRONT PANEL KEY CONTROLS

4. Remote Control

All controls located on the frontal keypad of the DVR may also be controlled via the IR remote controller (included). The buttons located on the remote controller correlate with the frontal keypad of the DVR. Press the “Menu” button on the remote controller to access the main menu of the DVR.

CHAPTER

5

GRAPHICAL USER INTERFACE

The operation of the DVR is GUI (Graphical User Interface) based. All menus and configuration settings are made graphically for ease of use and navigation. Specific icons are used to represent a menu, e.g. a Camera icon is used to represent the camera settings menu for the DVR.

CHAPTER 5. GRAPHICAL USER INTERFACE

1. General GUI Convention

To navigate, configure, and to operate the DVR unit, there are few things about how the Graphic User Interface is arranged. For the purpose of reference and easy operation this section will show what conventions are used to explain to use and navigate through the user interface.

Popup Menus and their components

There are many popup menus found on the GUI. Some popup menus are simple type and some have sub menu available for further options.

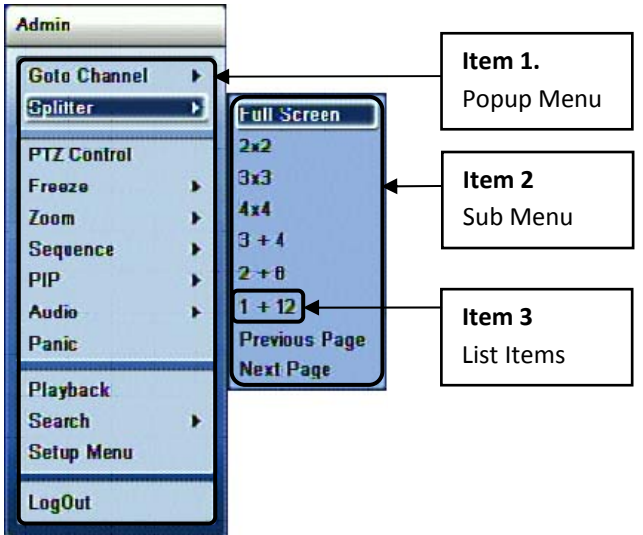

Figure 17 Example of Popup menu with sub menu

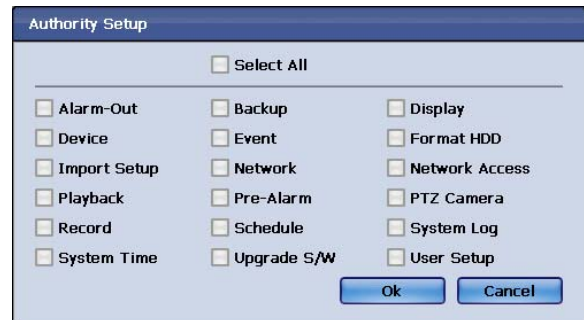

Figure 18 Example of Simple Popup menu

As shown on Figure 17 Example of Popup menu with sub menu some popup menus have many sub categories that you could choose from.

For the example shown on “Monitoring” popup menu (Item 1) the selectable “Sub Menu” (Item 2) items are “Goto Channel”, “Splitter”, “PTZ Control”, “Freeze”, “Zoom”, “Sequence”, “PIP”, “Audio”, “Panic”, “Playback”, “Search” and “Setup Menu”.

Example also shows with “Splitter” sub menu chosen there are List Items (Item 3) such as “Full Screen” “2X2”, “3X3”, “4X4”, “3+4” “2+8”, “1+12”, “Previous Page” and “Next Page”.

Also there are many simple popup menus without additional sub menu items. They are classified as simple popup menu and Figure 18 Example of Simple Popup menu shows an example of selecting user Authority setup popup.

CHAPTER 5. GRAPHICAL USER INTERFACE

2. Monitoring Popup Menu

Monitoring popup menu is the first menu that user will encounter. It is at this popup menu that will link to all of the operation and configuration options will be accessible.

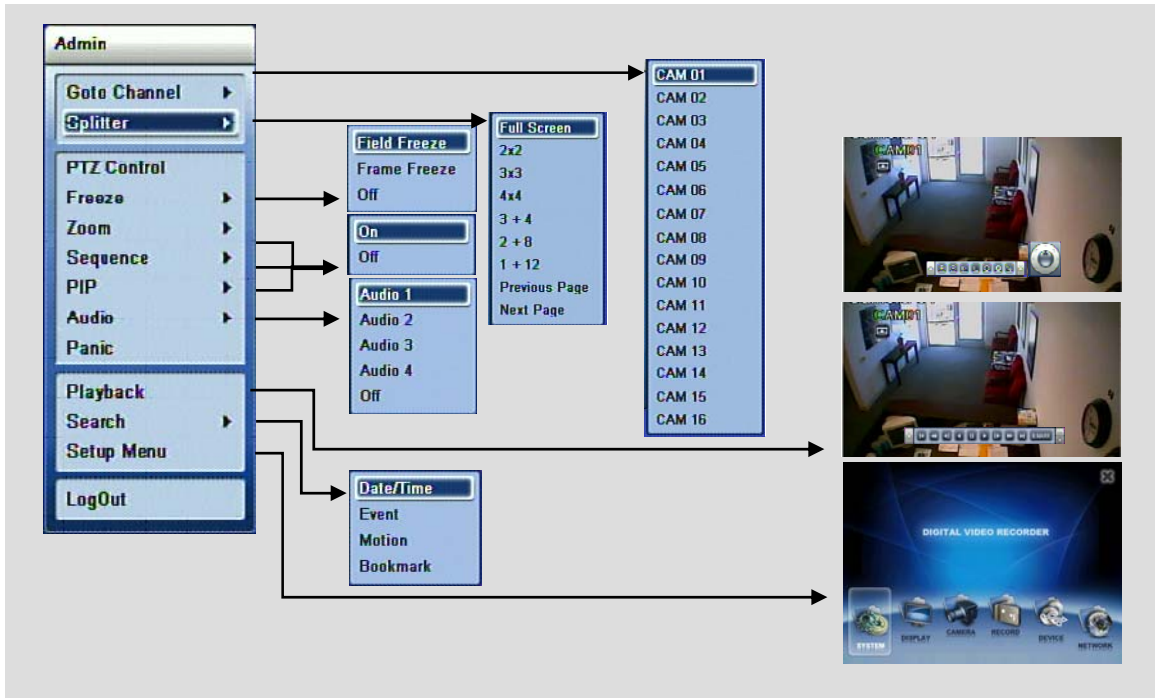

Figure 19 Monitoring Popup with all Sub Menu items

As you can see from the Figure 19 Monitoring Popup with all Sub Menu items the Monitoring Popup will be the starting point for the setup and operation of the DVR unit.

Main Setup Menu

The Main Setup Menu may be accessible

To access the main menu, press the “Menu” button on the frontal keypad or remote controller, or you can right click the mouse from the live view display and click on “Menu”.

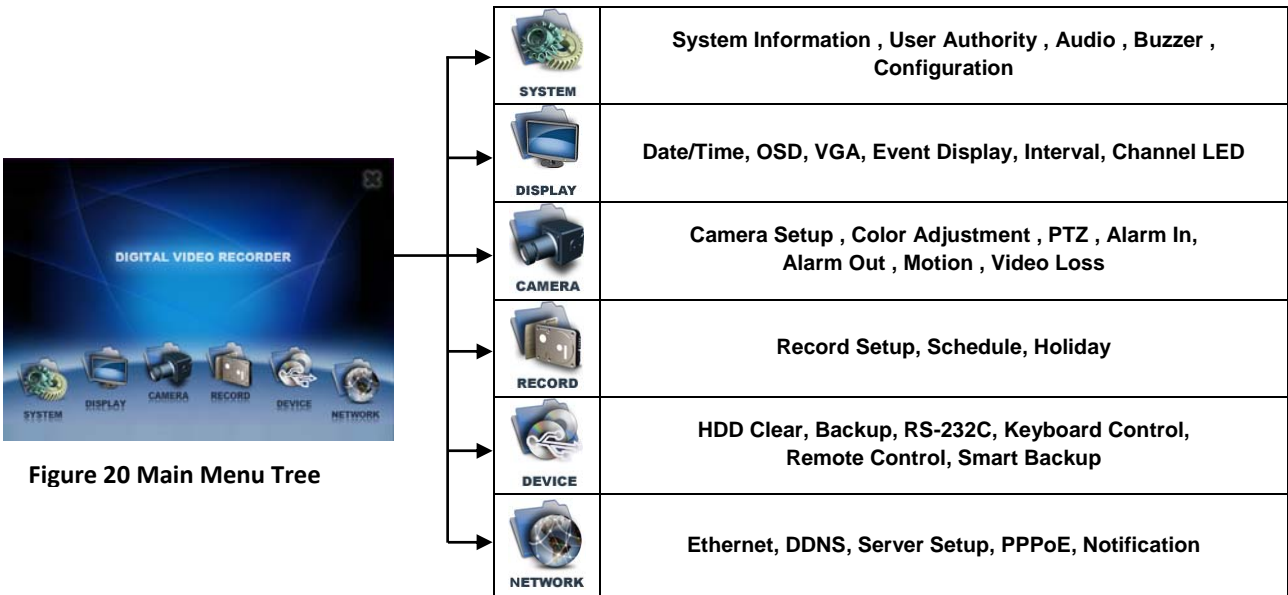

Figure 20 Main Menu Tree

CHAPTER

6

SYSTEM INFORMATION

System Information window provides three sections indicating detail information about the DVR unit. They are **Version**, **Storage**, **System Log**. They each indicate status information pertaining to the DVR unit. General information regarding the DVR unit and wellness of the unit can be checked on this section. Also in this section **HDD Clear** will be covered as well. In Storage window tab there is Quick Access button let allows quick jump to HDD Clear window. The **HDD Clear** window is grouped under Device section originally.

CHAPTER 6. SYSTEM INFORMATION

1. DVR Software / Hardware Version Information

Current software version (also referred to as a firmware) and hardware version is indicated in this section. You may access this window by utilizing the drop down button located on the left hand corner for quick navigation. Make sure that from the drop down list you select System Information.



Figure 21 System information with Version tab selected

CHAPTER 6. SYSTEM INFORMATION

2. Software (Firmware) Update

Software Version Update

1. To update the software version to newly available software revision, please copy the software file to the removable USB memory stick device.
2. After check for the update file on the USB media device, insert the USB memory stick device to the USB port located on the front of the DVR. (See page 9 for location) Navigate to System Information window and click Update button located on the center of the window.



(See Figure 21 System information with Version tab selected)

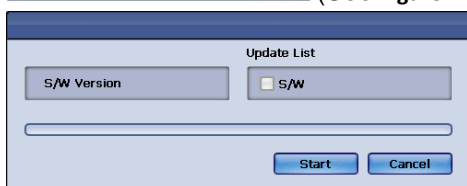

Figure 22 S/W Version Update Popup

Popup window will appear as shown above, please click start to initiate the software update.



If the USB memory stick is not present or file is not correct software file, system will prompt error message.

You must use caution when updating software to the DVR unit. These conditions are must be kept when upgrading software (firmware) for the DVR unit.

1. Check that software image on USB memory stick has same size as file copied from.
2. Do not power off the system during software (firmware) update.
3. Do not perform software (firmware) update with different product's software image.
4. Be sure to wait for system prompt, turn off DVR unit when told so by the prompt by the DVR unit.
5. After software (firmware) update make sure to perform factory default procedure.

CHAPTER 6. SYSTEM INFORMATION

3. Hard Disk Drive Information

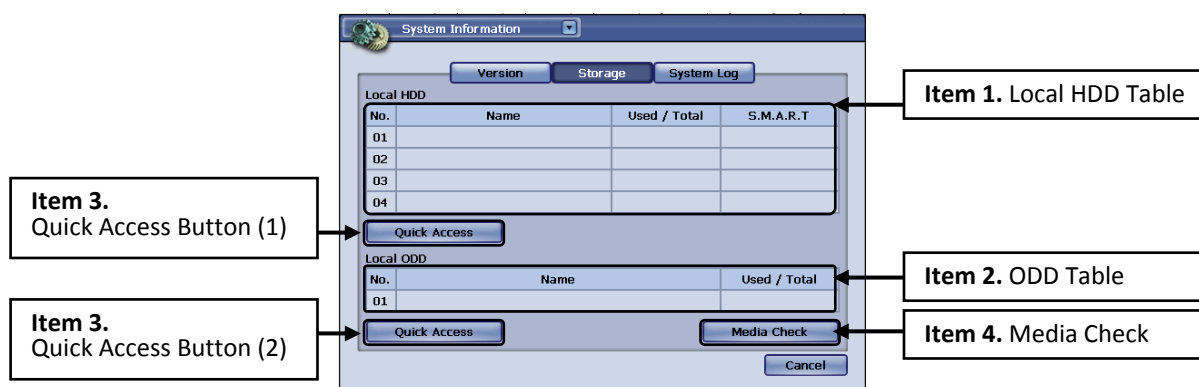

Figure 23 Storage Tab Window

The Storage tab window displays information about storage devices that are being used as your main location for the video images. Each drive's name, total size currently allocated with data and wellness of the hard disk drive is indicated in this window.

| | |
|--------|--|
| ITEM 1 | Local HDD table Shows the detailed status information regarding locally installed hard disk drives |
| ITEM 2 | ODD table Shows the detailed status information regarding Optical Disk Drive(DVD-R) |
| ITEM 3 | Quick Access button (1) It is a button that enables HDD clear window. It enables quick access to Hard disk clear operation. Quick Access button (2) It is a button that enables Backup window. It enables quick access to backup procedure. |
| ITEM 4 | Media Check Shows how much recorded data is in an inserted DVD media. |



You may have up to maximum of four hard disk drive internally, or three internal hard disk drive and one extension hard disk drive externally the via E-SATA.
Local HDD table (See Figure 23 Storage Tab Window of Item 1)

In the table under Local HDD **No.** represents internal hard disk drive ID.

In the table under Local HDD **Name** represents the hard disk name and model is displayed.

The **Used / Total** section indicates current usage for the particular hard disk drive with data written by the DVR unit.



If you had chosen the option to overwrite then the **Used** portion will be equal to the **Total** portion after reaching maximum recording capacity. The overwrite option will start erasing earliest recorded data and replace it with current recording data. If you have multiple hard disk drives installed, then first drive will be written and when data is full then the DVR will start recording to the next available drive until they are all full. When all drives all completely full, then earliest recorded data will be replaced with current recorded data. It is the user's responsibility to backup critical evidence information. If the evidence worth video is overwritten, there is no option recover such data.

On the DVR system health status is represented in % sign, and in () it indicates the temperature of the hard disk drive represented by Celsius.



Normal operating temperature of any hard disk drive should be in range of 0~60°C. Recommended optimum temperature range is between 36°C and 47°C (about 97° Fahrenheit to 117° Fahrenheit). Every hard disk manufacturer may have different range and tolerance, please consult with your hard disk manufacturer for operating temperature range. If hard disk drive is running hotter than recommended temperature provided by the hard disk manufacture, then please check to see if the DVR unit's ventilation is not blocked and check your room temperature immediately. Failure to do so will damage the DVR and the hard disk drive.

Extension HDD table (See Figure 23 Storage Tab Window of Item 2)

Extension hard disk drive may be mounted on the DVR for alternative increase of the hard disk storage option for the DVR. Utilization of E-SATA standards enables user to mount E-SATA compliant storage devices and external storage solutions. Often times these solutions are used to implement RAID solution and increase hard disk storage capacity. There are certain limitations when using such option and please check below items before deciding to use external E-SATA storage solution.



CHECK LIST BEFORE USING EXTERNAL E-SATA STORAGE SOLUTION

1. There must only be three or less internal hard disk drive present before E-SATA utilization.

2. External E-SATA device must be configured using one volume. You may have multiple drives by utilizing RAID enclosure. However they must be shown as single volume after configuration. (please consult with external hard disk enclosure manufacturer for details)

Note: Simple single drive E-SATA enclosures will operate without any compatibility issues, however E-SATA drives must also be one of the drive that are compatible with the DVR system. Please check with your dealer for hard disk compatibility list.

Quick Access button (See Figure 23 Storage Tab Window of Item 3)

The **Quick Access** button is provided to jump to the **HDD Clear** window section. It is in this **HDD Clear** window section that you could clear all data items for the hard disk drives installed for the DVR unit. This button will invoke HDD Clear window. (See **Figure 24 HDD Clear Window**)

CHAPTER 6. SYSTEM INFORMATION

4. Hard Disk Drive Management

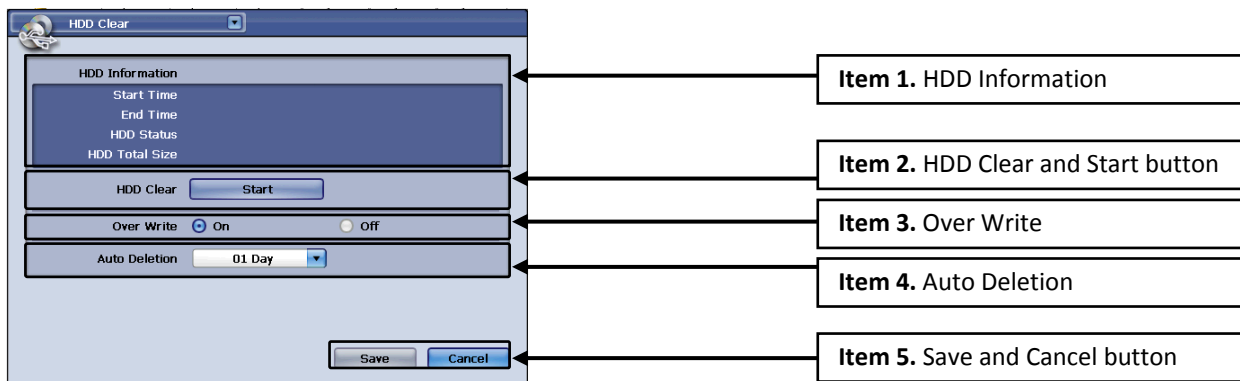

Figure 24 HDD Clear Window

HDD Clear window shows the HDD information, option to clear the hard disk drive, set overwrite option and to have auto deletion function enable. Each drive's total size currently allocated with data and space available of the hard disk drive is indicated in this window.

| | |
|---------------|---|
| ITEM 1 | <p>HDD Information (active status display for hard disk drive) Start Time: indication that shows when the first data is present by time when the first data was recorded. End Time: indication that show when the last data is present by the time when the last data was recorded on the hard disk drive. HDD Status: indication of current status of the hard disk drive. HDD Total Size: indication of total Hard disk size installed for the DVR</p> |
| ITEM 2 | <p>HDD Clear Start button: initiates hard disk clear option.</p> |
| ITEM 3 | <p>Over Write On and Off radial button: you may choose on the enable overwrite option and off (default) to disable the overwrite option.</p> |
| ITEM 4 | <p>Auto Deletion Auto Deletion drop down button: you may select set time parameter to start deleting the recorded data regardless of storage space left over on the hard disk drive. (Example: if parameter is 1 day even if there is enough hard disk storage space capable of recording more than 1 day might be present system will only keep data for 1 day worth and will overwrite the information present in hard disk drive.)</p> |
| ITEM 5 | <p>Save and Cancel Save button: use this button to commit the current configuration set on the HDD Clear window. Cancel button: use this button to cancel the current configuration set on the HDD Clear window.</p> |



CAUTION!

You must use caution before using **the HDD Clear button**. Unlike other parameters in HDD Clear window, upon clicking the Start button of the HDD Clear section will engage the hard disk format to the installed hard disk drive. This action will erase all information in hard disk drive. **Auto deletion** feature will take precedence over overwrite feature being off. If you do not want the hard disk drive to be overwritten, please check the setting in **Auto deletion** section and set it to none.

CHAPTER 6. SYSTEM INFORMATION

5. System Log

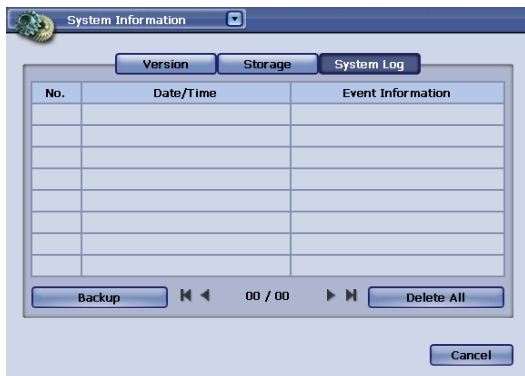

In **System Log Tab** page you will be able to see the logs generated by the DVR system. The **Date/Time** column shows the event occurred time and **Event Information** shows types of event logged by the DVR system.
Types of Logs available in the DVR system

Figure 25 System Log Tab Page

| | | | |
|---|--------------------------------|---|------------|
| 1 | Motion | 2 | Alarm |
| 3 | Panic | 4 | Video Loss |
| 5 | (System Log (To be applied)) | 6 | |

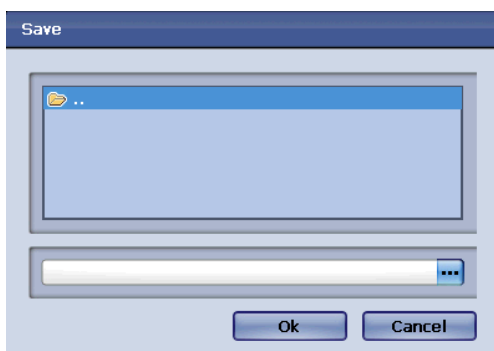

Figure 26 Save Popup

CHAPTER

7

USER SETTING

This section will be dedicated for how to configure User setting and setting the authorities associated to each user types. Also this section will indicate how to log in to the DVR unit and cover auto login procedures as well.

CHAPTER 7. USER SETTING

1. Types of Users Available

Administrator user Account

There is only one Administrator Account configurable in the DVR system. It is assigned with unchangeable User ID marked as **Admin**. The default password is blanked out and administrator account has full access to the DVR and its configurable parameters. The Administrator Account also has ability to assign rights to the Manager Accounts and User Accounts.



By default Admin account has no password and it is strongly advised that you secure the DVR with administrator password. If you do not set the Admin password then anyone may able to erase evidence, access the DVR via network, and change parameters to the DVR system. Password settings will be covered in this chapter.

Manager User Account

The Manager user accounts are usually given to users that requires more privileges compared to than Regular User account. Manager accounts also have ability to assign privileges to the Regular User accounts. Limitations will be that Manager Account only may grant user privileges that Manager Account currently possesses.

Manager User Account IDs are defaulted with Manager1 ~ Manager 3.

Regular User Account

The Regular User Accounts are usually given to users that require performing certain task without having the full access of the privileges. They are the simplest type of user account arranged by IDs in range of User 1 ~ User 7.

CHAPTER 7. USER SETTING

2. Configuring Users in User Authority Window

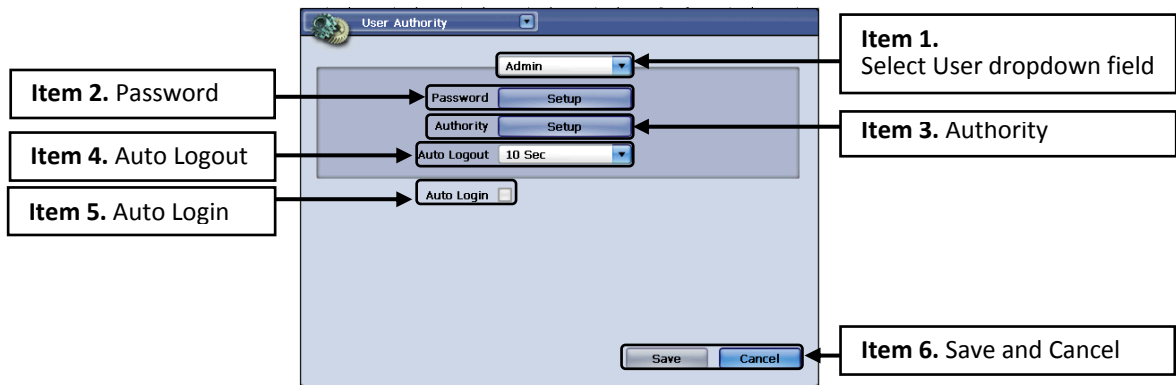



Figure 27 User Authority Window

In **User Authority** window, all the accounts available in the DVR system will be configurable.

| | |
|---------------|--|
| ITEM 1 | <p>Select User Type</p> <p>Select between Admin, Manager 1, Manager 2, Manager 3, and User 1 ~ User 7. Select the user first before continuing with other configuration.</p> |
| ITEM 2 | <p>Password Setup button</p> <p>It will bring up the Popup window called Password. In this popup you will need to provide current password and input new password. End by confirming the new password and select "OK" button.</p> <div style="border: 1px solid black; padding: 5px; margin: 10px 0;"> </div> <p style="text-align: right;">Figure 28 Password Setup</p> |

| | |
|---------------|---|
| ITEM 3 | <p>Authority Setup button</p> <p>Upon clicking Setup button next to Authority field it will bring up Authority Setup popup window. In this popup window you may select privileges associated with accounts selected in Item 1. Select User Type. In this window you may enable all check boxes by selecting Select All check box. From here you may uncheck any or all user privileges you want to assign to particular selected user account. Upon completion of selecting appropriate user privileges save by clicking the “OK” button. Cancel by selecting the “Cancel” button. Repeat for other user type by reselecting Item 1. Select User Type and follow the same procedure.</p>  <p style="text-align: right;">Figure 29 Authority Setup Popup</p> |
| ITEM 4 | <p>Auto Logout selection</p> <p>This section configures the time parameters to auto lock the DVR unit and takes it back to the “Live” display mode. You have to login again to setup or operate the DVR unit</p> |
| ITEM 5 | <p>Auto Login check box</p> <p>With this check box checked, you are not required to provide login when navigating from “Live” display mode to “Setup” screen.</p> |
| ITEM 6 | <p>Save and Cancel</p> <p>Save button: use this button to commit the current configuration set on the HDD Clear window. Cancel button: use this button to cancel the current configuration set on the HDD Clear window.</p> |

CHAPTER 7. USER SETTING

3. Types of User Authority

There are 18 different types of User authority that may be assigned to both Manager Accounts and Regular User Accounts. (See **Figure 2 Authority Setup Popup**)

| | | | | | |
|----|------------|----|------------|----|----------------|
| 1 | Alarm-Out | 2 | Devices | 3 | Import Setup |
| 4 | Playback | 5 | Record | 6 | System Time |
| 7 | Backup | 8 | Event | 9 | Network |
| 10 | Pre-Alarm | 11 | Schedule | 12 | Upgrade S/W |
| 13 | Display | 14 | Format HDD | 15 | Network Access |
| 16 | PTZ Camera | 17 | System LOG | 18 | User Setup |

CHAPTER

8

AUDIO / BUZZER

In this chapter Audio options for both inbound audio and outbound audio will be covered. The Buzzer section also covers the assignment of audible alerts given by the internal to the DVR unit.

CHAPTER 8. USER SETTING

1. Audio Window

In the Audio window, accessible by quick navigation via the drop down button located near the top left portion of the window, you have options to configure Microphone and speakers volume. Also it is this section that you have an option to disable inbound and outbound audio option.

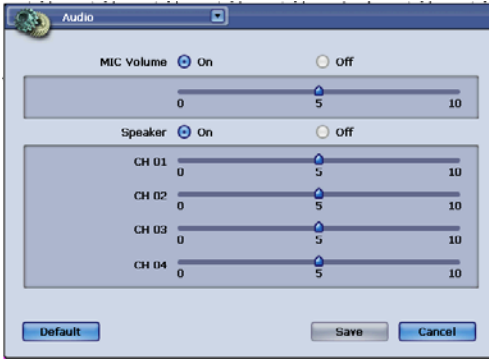

Figure 30 Audio Window

MIC Volume has selectable radial buttons “On” and “Off”. With radial buttons selected to the “On” setting you may also control the volume for the microphone.

Speaker section also has selectable radial buttons “On” and “Off”.

With radial buttons selected to the “On” setting you may also control the volumes for the 4 available channels for audio output.

The “Default” button enables the factory default parameters of the audio section.

The “Save” and “Cancel” buttons either commits or cancel the configured audio setting changed during the audio setup process.

CHAPTER 8. USER SETTING

2. Buzzer Window

In the Buzzer window you have options to configure system buzzer to sound depending on the selectable criteria. Some buzzer will sound for fixed amount of time and some will sound until attention is given to stop the audible alert.



Figure 31 Buzzer Window

On the top to the page you will find two radial buttons “On” and “Off”. With “On” button selected audible beep will be enabled and with “Off” selection it will disable any audible beep.

With “Select All” check box checked, all the check boxes below will be checked as well. There are five types of criteria configurable to sound off the audible beep.

CHAPTER 8. USER SETTING

3. Listening to Audio in Live View

After successful configuration of the audio in order for you to hear certain audio channel you must enable the audio from the **Monitoring** Popup menu. Speaker device must be connected and turned on from the DVR unit.



To enable audio, from the live view image click on **[Menu]** button on frontal key pad or the remote controller. Navigate using directional key buttons to go to “Audio” sub menu item and click enter, navigate using directional key pad to select **Audio 1~4** or **Off**.

Figure 32 Enabling Audio from Monitoring Popup



MOUSE OPERATION EXAMPLE

To easily navigate with USB mouse, you may right click on the live view screen and hover to the **“Audio” Sub Menu** item from the Monitoring popup then left mouse button click to shown **List Items** for Audio Sub Menu. Left Mouse button click on **Audio 1 ~ 4** to enable audio or Left Mouse button click on **Off** to disable audio.

CHAPTER 8. USER SETTING

4. Listening to Audio in Search View

After successful configuration of the audio in order for you to hear certain audio channel you must enable the audio from the Playback Popup menu. Speaker device must be connected and turned on from the DVR unit.



To enable audio, from the Playback mode click on **[Menu]** button on frontal key pad or the remote controller. Navigate using directional key buttons to go to **“Audio” sub menu** item and click enter, navigate using directional key pad to select **Audio 1~4** or **Off**.

Figure 33 Enabling Audio from Playback Popup Menu



MOUSE OPERATION EXAMPLE

To easily navigate with USB mouse, you may right click on the Playback screen and hover to the **“Audio” Sub Menu** item from the Monitoring popup then left mouse button click to shown **List Items** for Audio Sub Menu. Left Mouse button click on **Audio 1 ~ 4** to enable audio or Left Mouse button click on **Off** to disable audio.

CHAPTER



IMPORT / EXPORT / RESET CONFIGURATION

When working with multiple DVR units, it is often desired, that all DVR units to share certain configuration parameters. Configuration files may be imported, exported and applied with factory default operation applicable in six different categories. These categories are identical to first six icons seen on Main Setup page as well. They are System, Display, Camera, Record, Device, and Network. In this chapter we will discuss how to import and export the configuration setting parameters. In later portion of this chapter, this manual will also show you how to perform factory default procedures as well.

CHAPTER 9. IMPORT / EXPORT / RESET CONFIGURATION

1. Import and Export Configuration

To import and export the DVR units system configuration file you must navigate to window titled **Configuration**. You may access this window by using drop down list button located on upper left corner from any window or in **Main system menu** click on to System Menu button than select **Configuration**.

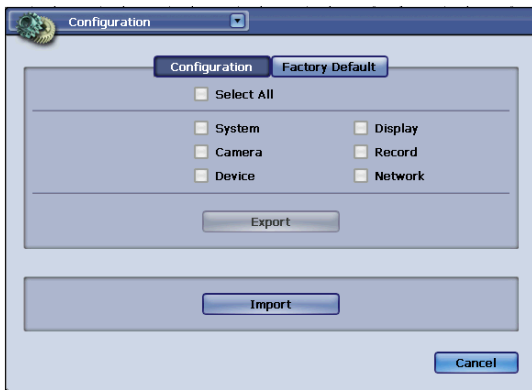

The Select All button enables all check box items to be selected.

There are six categories of configuration possibilities listed after check box and they are **System, Display, Camera, Record, Device, and Network**. They are the same categories of items selectable at Main system menu.

Figure 34 Configuration Window with Configuration button selected

Import configuration

To import configuration file, click on the button marked “**Import**” and bring up the Import popup window.

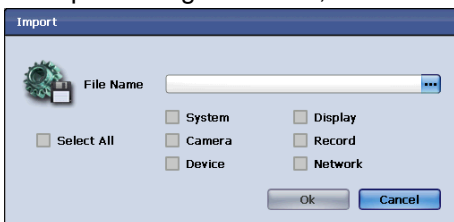

Figure 35 Import Popup Window

Click on three dotted button show on left to define path and file name of file to be imported.

Export configuration

To export configuration file, click on the button marked “**Export**” and bring up the Export popup window.

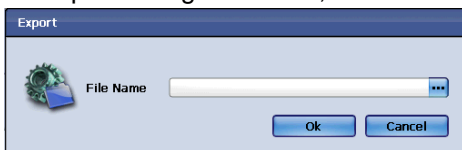

Figure 36 Export Popup Window

Click on three dotted button show on left to define path and file name of file to be exported.



Note:

For the DVR unit configuration files could only be imported and exported by using the external USB memory stick. Import and Export functions are not currently supported via the Network transmission.

CHAPTER 9. IMPORT / EXPORT / RESET CONFIGURATION

2. Factory Default Configuration

In some occasion it is recommended that you perform Factory Default Configuration. When the DVR unit has upgraded HDD, Software (Firmware) update, and when instructed by technical support agent to reconfigure the settings.

To navigate to the Factory Default Configuration section you must navigate to the Configuration window. You may access this window by using drop down list button located on upper left corner from any window or in **Main system menu** click on to System Menu button than select **Configuration**.

There are six categories of configuration possibilities listed after check box and they are **System, Display, Camera, Record, Device, and Network**. They are the same categories of items selectable at Main system menu.

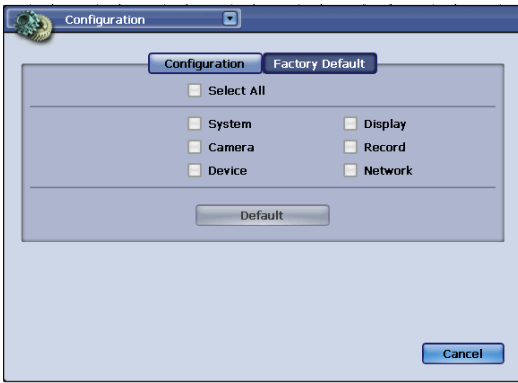

To apply the factory default setting first select the categories of settings that needs to apply factory default to. Then simply press the “Default” button on the center of the screen to apply the factory default configuration.

Figure 37 Configuration Window with Factory Default button pressed

CHAPTER

10

DATE AND TIME

In this chapter all component of date and time configuration will be discussed. In This chapter will show you in detail how to configure the DVR unit’s system time, apply daylight savings parameters, and to program the DVR unit to reference time server to synchronize time settings.

CHAPTER 10. DATE AND TIME

1. Configuring System Time Manually

All about time configuration can be changed in Date/Time window. You could access the **Date/Time** window by clicking the drop down button located on the left upper corner or by accessing via **Display** icon from **Main menu** screen. In this **Date/Time** window you will be able to locate three tabbed buttons called **Sys. Time**, **DST Time**, and **NTP**.

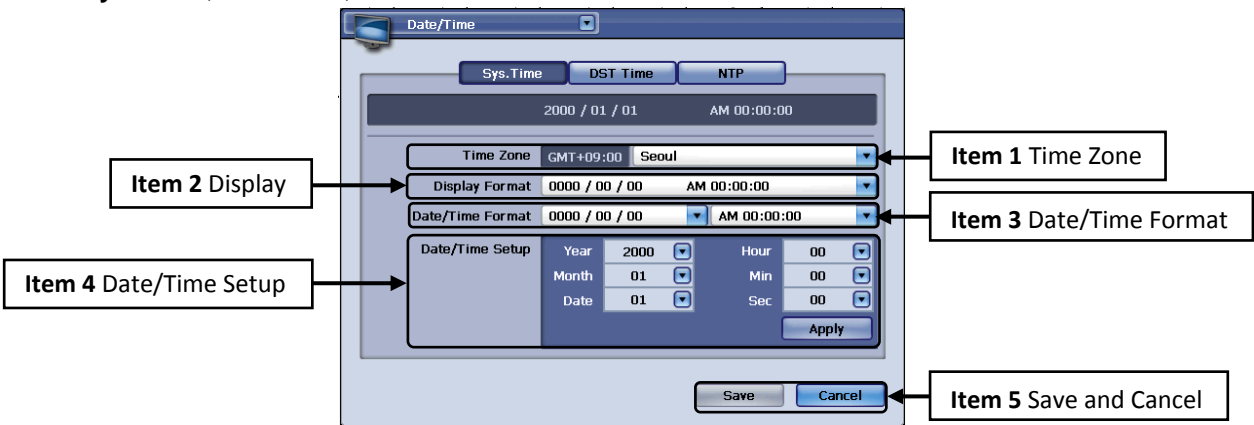

Figure 38 Date/Time Window with Sys. Time Tab selected

To manually configure system time, you must do so in **Date/Time** window with **Sys. Time** tab section (See Figure 38 Date/Time Window with Sys. Time Tab selected).

In this window there are five configurable items.

| | |
|---------------|---|
| ITEM 1 | <p>Time Zone</p> <p>In this section, please select appropriate time zone by clicking on the drop down icon button and select your location. If your location can not be found please check for the nearest city and check the GMT (Greenwich Mean Time) indicated.</p> |
| ITEM 2 | <p>Display Format</p> <p>In this section, toggle between date and time or time and date position</p> |

| | |
|---------------|--|
| ITEM 3 | Date/Time Format In this section, choose how the date and time will display. You may choose the year to appear first or months to appear first. On time section you may choose 24 hour display or A.M. and P.M. display. |
| ITEM 4 | Date/Time Setup In this section, manually input current system time by selecting year, month, date, hour, minute, and second. |
| ITEM 5 | Save and Cancel Save button: use this button to commit the time configuration set on the Date/Time window. Cancel button: use this button to cancel the time configuration set on the Date/Time window. |



CAUTION! You must perform Hard Disk Clear procedure after the time change. Especially, when time setting has been back dated, perform the Hard Disk Clear procedure. There could be duplicate recording events recorded on to the hard disk drive and may corrupt hard disk indexing operation. Before performing the hard disk format, please backup any important data items.

CHAPTER 10. DATE AND TIME

2. Daylight Savings Time Configuration

Some regions of the world, DST (Daylight savings time) must be configured to have correct time to display after DST changes. To configure the DST setting click on DST Time tab button from Date/Time window. (Figure 39 Date/Time Window with DST Time selected)



Figure 39 Date/Time Window with DST Time selected

To enable DST option, please locate “On” radial button and select it to enable DST option. It is “Off” as default.

DST Start Time: In this section you can choose which month, which month, which day and which hour that DST will start.

DST End Time: In this section you can choose which month, which month, which day and which hour that DST will be set to normal time.



Note:

*Many North American countries: Since 2007, daylight saving time starts on the second Sunday of March and ends on the first Sunday of November, with all time changes taking place at 2:00 a.m. local time. **Please check your region’s DST time rules.***

CHAPTER 10. DATE AND TIME

3. Synchronized Network Time Setting Configuration

Multiple DVR units may have synchronized time by utilizing network time configuration. They could be configured by using NTP settings provided with the DVR. You will be able to locate this page by clicking on **NTP** tab button found on **Date/Time** window. You could access the **Date/Time** window by clicking the drop down button located on the left upper corner or by accessing via **Display** icon from **Main menu** screen.

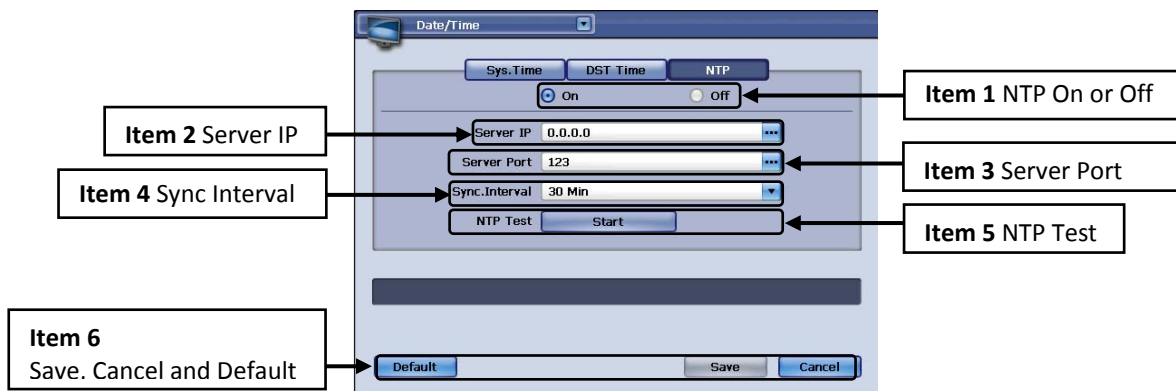

Figure 40 Date/Time Window with NTP button selected

| | |
|--------|---|
| ITEM 1 | <p>NTP On or OFF</p> <p>In this section, you may enable NTP by selecting “On” radial button and disable it by selecting “Off” radial button.</p> |
| ITEM 2 | <p>Server IP</p> <p>In this section, provide IP address number for the NTP time server IP address.</p> |
| ITEM 3 | <p>Server Port</p> <p>In this section, provide Port number for the NTP time server.</p> |
| ITEM 4 | <p>Sync. Interval</p> <p>In this section, define synchronization interval time by selecting drop down button.</p> |
| ITEM 5 | <p>NTP Test</p> <p>In this section, press the “NTP Test” button to test the connection to the time server. Upon successful connection, system will prompt Connection Success message. If connection can not be established then, it will prompt Connection Failure message will show.</p> |
| ITEM 6 | <p>Default, Save or Cancel button</p> <p>Click on the “Default” button to reset all parameter in current window.</p> <p>Save button: use this button to commit the time configuration set on the Date/Time window.</p> <p>Cancel button: use this button to cancel the time configuration set on the Date/Time window.</p> |

CHAPTER

11

DISPLAY

In this chapter configuration options for display related setting are discussed. They are the option settings for the On Screen Display, VGA monitor settings, SPOT Monitor settings and Picture in Picture settings.

CHAPTER 11. DISPLAY

1. On Screen Display

The On Screen Display (OSD) options dictate how label indicators will display for both live display screen and for playback display screen. It is also this section that you will choose system language, viewable margin, and window transparency settings. OSD window may be accessed by using the drop down button located near upper left corner of any configuration window.

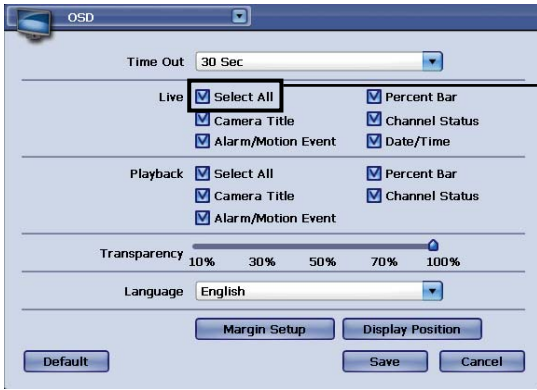

Item 1

Time Out selection clears out the OSD display items to clear when there is no input action is performed.

There are identical check boxes available for **Live** and **Playback** section. These check boxes are to choose what display items to appear for live and playback display screen.

Figure 41 OSD Window



Figure 42 Live display screen (4channel view)

| | | |
|--------|---|--|
| ITEM 1 | Select All Check Box Check all checkbox items under Live and Playback section (Will enable items 2~5) | |
| ITEM 2 | Camera Title Display Camera Title for Live and Playback display | |
| ITEM 3 | Alarm/Motion Event Shows Alarm and Motion icons in Live view and indicate such event | |
| ITEM 4 | Percent Bar Shows current HDD utilization | |
| ITEM 5 | | Channel Status When chosen, upon video loss it labels the camera channel with "Video Loss" indication |
| ITEM 6 | Date/Time Shows date and time label for Live and Playback display Transparency setting has five different settings you could choose from. | |

- They are:** Level 1: 10% transparency
 Level 2: 30% transparency
 Level 3: 50% transparency
 Level 4: 70% transparency
 Level 5: 100% transparency

These transparency settings are applied for all windows and popup menu items on the DVR system. **Language** section is the location to choose the DVR system language.

Languages available to the DVR system are, English (default), Korean, Japanese, Chinese, French, German, Italian, Spanish, and other languages.

Margin Setup button will bring up the

Figure 43 Margin Setup Popup to control the viewable margin for the live view screen display.

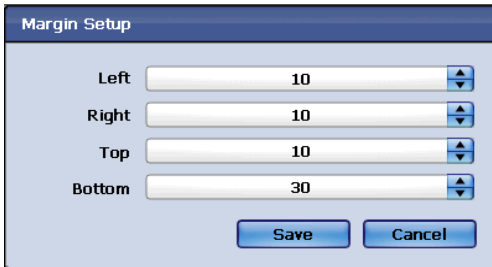

Screen display may be positioned by using the **Left, Right, Top** and **Bottom** marginal selector they range from 0~+30.

Figure 43 Margin Setup Popup

Default button will set all settings to default parameters.

Save **Cancel** Use this button to either commit the configuration to save or to cancel.

CHAPTER 11. DISPLAY

2. VGA Configuration

The DVR unit has one available VGA port. (For Connection example see CHAPTER 3 Hardware Cofiguration **Figure 6 VGA Pin Description**). VGA port allows standard computer monitor that has VGA connection to be connected to the DVR unit.



Check this first:

Your monitor must support below resolution.

Resolution rate of 640X480 at 60HZ or 70HZ refresh rate.

Resolution rate of 800X600 at 60HZ or 70HZ refresh rate.

Resolution rate of 1024X768 at 60HZ or 70HZ refresh rate.

Resolution rate of 1280X1024 at 60HZ or 70HZ refresh rate.

Check your monitor user's guide.



On this window you may choose

Resolution rate of 640X480, 800X600, 1024X768, or 1280X1024 (Normal)

1680X1050, 1440X900,

1360X768 (Wide)

Frequency of 60Hz or 70Hz (Refresh rate)

Figure 44 VGA Configuration Window

Default button will set all settings to default parameters.

Save **Cancel** Use this button to either commit the configuration to save or to cancel.

CHAPTER 11. DISPLAY

3. Spot Monitor Settings and Operation

For the DVR unit there are two types of Spot Monitor types are available. First type of Spot monitor is programmable **Digital Spot** monitor. And second type is **Analog Spot** monitor that has simple configuration setting. In this section of the chapter we will tell you the difference between these two types of Spot monitors and show how they could be configured.



Note: Analog Spot Monitor Operation Order
 Sequencing of Channel 1 ~ Last Channel of camera with sequence time defined.
 When event is triggered then the view of the camera with event will display until event is no longer happening.

If event is to occur simultaneously with Channel 1 and other channel, then the DVR unit will wait until the event in Channel 1 will complete and will move to next channel with an event.

Monitor Event Configuration

Analog Spot Monitor configuration has full screen view switching between given interval time. They may be enabled to react to the Alarm and Motion event configurable by each channel.

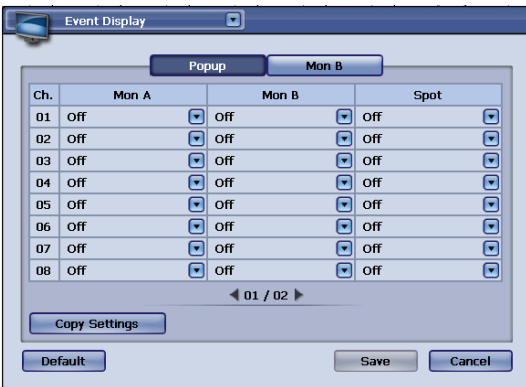

Enable or disable Event display by selection “Alarm, Motion, A+M” or “Off” radial button.

Figure 45 Spot Window with Spot Tab selected



button will set all settings to default parameters.



Use this button to either commit the configuration to save or to cancel.

Copy Setting

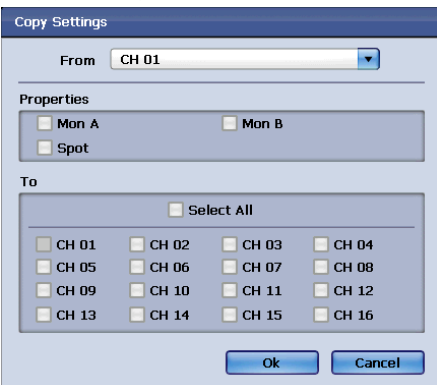

Figure 45-1

Digital Spot Monitor Configuration (Monitor B)

In Digital Spot monitor configuration you can configure how the monitor will sequence the picture by defined camera sequencing in order. You may have a full channel view sequencing and then have 2X2 split display of assigned camera to follow.

Digital Spot Schedule Configuration

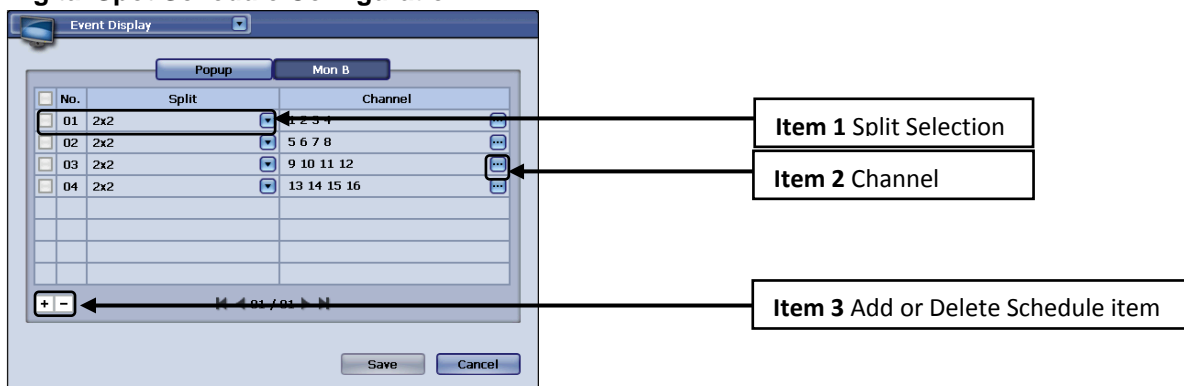

Figure 46 Spot Window with Spot Schedule tab selected

| | |
|---------------|---|
| ITEM 1 | <p>Split Selection Choose between “Full” or “2X2”</p> |
| ITEM 2 | <p>Channel Selector Upon clicking the channel selection button popup of the channel selector will appear. Click either 1 or up to 4 camera (when selected 2X2 in the Split Selection section)</p> |

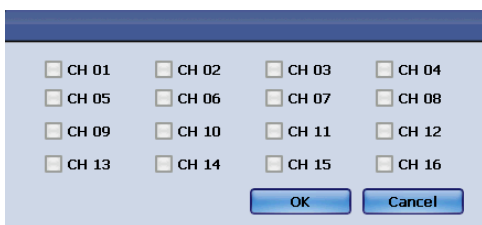

Figure 47 Channel Selection Popup

Add or Delete Schedule item.
To add just press the icon marked “+” to add another line

| | |
|---------------|---|
| ITEM 3 | <p>To delete a line first select the line by pressing the check mark and then press icon marked “-“ to delete</p> |
|---------------|---|



Note: Maximum Digital Spot Entry
You may have up to 21 lines of schedule entry.
That means that you may have up to 21 programmed line items and on Digital Spot monitor, there could be 21 different sequencing combinations

To help you understand the configuration of digital spot option we will consider a scenario and configure the Digital Spot to meet the requirement.

Possible Scenario:

You have a 16 channel DVR unit with 14 cameras enabled in channel 1~16 with Camera 9 and Camera 11 with no video feed. You want to install a Spot Monitor in front lobby to always see camera 1. You want to see full screen view of camera 1 then few seconds later 2X2 screen view with Camera 1, Camera 2, Camera 3 and Camera 4. Few seconds later you want it to sequence to 2X2 view with Camera 1, Camera 5, Camera 6 and Camera 7. You want to repeat until you see all cameras but omit camera 9 and camera 11 because they are not functional at this time. You want to have Camera 4 to popup during any of these sequencing events, when you detect motion to this camera.

CHAPTER 11. DISPLAY

4. Managing Interval Time

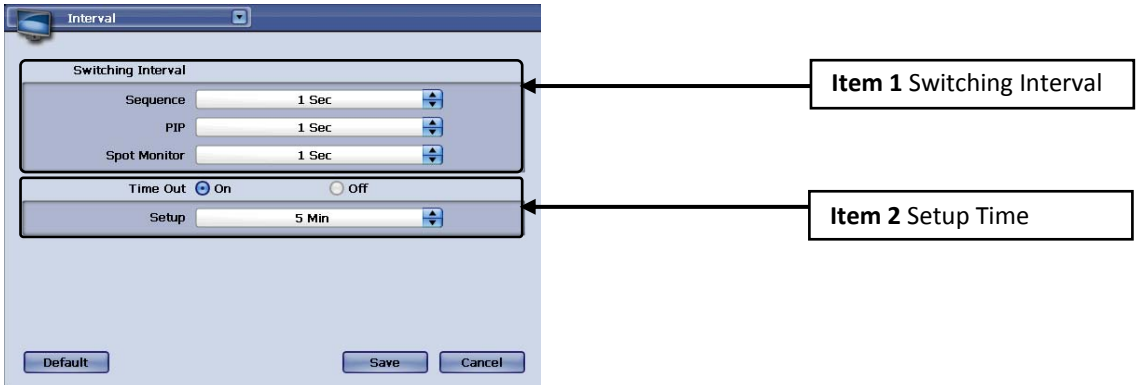

Figure48 Interval Window

| | |
|---------------|--|
| ITEM 1 | <p>Switching Interval</p> <p>Sequence drop down bar depicts the time settings for the sequence interval time for live view sequence when sequence button is pressed.</p> <p>PIP drop down bar depicts the time settings for the sequencing interval time for the Picture in Picture sequencing function.</p> <p>Spot Monitor drop down bar depicts the time settings for the sequence interval time for the both the analogue spot and digital spot out monitor sequencing time.</p> |
| ITEM 2 | <p>Setup Time Out</p> <p>Time Out radial button enables option to turn on or to turn off the Setup Time Out option. If Time Out radial button is On then you have selected the option to have setup menu return to live view after time selected on Setup interval time</p> |

Default button will set all settings to default parameters.

Save **Cancel** Use this button to either commit the configuration to save or to cancel.

CHAPTER 11. DISPLAY

5. Switching between Display Modes

Display Mode

In Live and Playback display you may change the display mode by clicking on the [Mode] button. It will toggle through various display modes by pressing the [Mode] button in frontal key pad.

You may also use the right mouse button click and choose the display view as indicated below in Live View mode and Playback View Mode.



Figure 49 Splitter in Live view



Figure 50 Splitter in Playback view

CHAPTER 11. DISPLAY

6. Channel LED Indicator



Figure 51

The LED on the channel button indicates the status as follows:

Red – Video Loss

Blue– Normal (When there is no event and the DVR is working as scheduled.)

Green – Motion detected

Red blinking – Alarm In (It will follow Alarm terminal input No.)

In Channel LED configuration you can configure what status you want to check from the LED of channel button.

CHAPTER

12

CAMERA

In this chapter all about the camera configuration and operation will be covered. There are fixed camera and PTZ camera that the DVR unit may control. Key advantage of connecting the camera via the DVR unit is that even in remote client application operation PTZ camera is maneuverable.

CHAPTER 12. CAMERA

1. Camera Setup

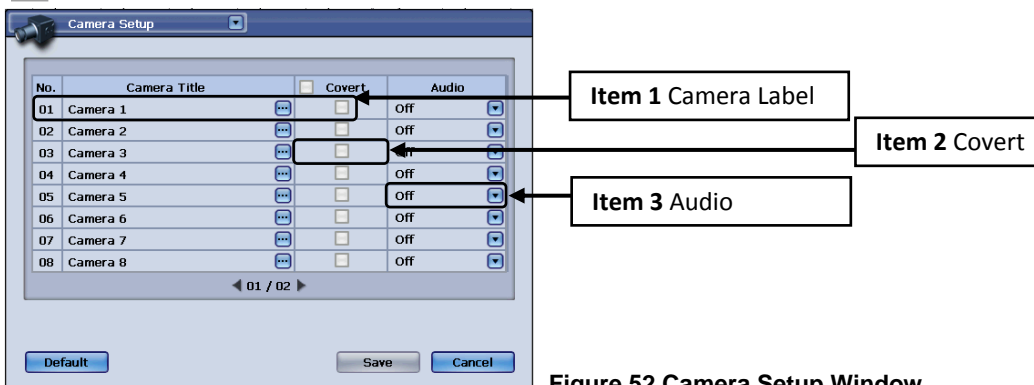
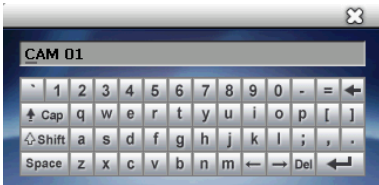

Figure 52 Camera Setup Window

| | |
|---------------|---|
| ITEM 1 | <p>Camera label Click on three dotted icon box to initiate on screen keyboard as seen below.</p>  <p>Type the desired label and "X" to close the popup window.</p> <p>Figure 53 On Screen Keyboard popup</p> |
| ITEM 2 | <p>Covert Click on the check box to enable the cover option. If chosen, camera will not appear on live screen display or remote connection.</p> |
| ITEM 3 | <p>Audio Choose the drop down bar to select the audio channel. This will associate audio to camera associated.</p> |

CHAPTER 12. CAMERA

2. Camera Color Adjustment

Some cameras will need color adjustment for it to depict the correct color scheme. You may choose the color settings individually then use the copy setting to apply the same configuration parameters to other cameras.



CHECK THIS FIRST!

Make sure the monitor being used is correctly configured to show proper colors. Consult your monitor manual for details in color configuration. Without having the color scheme correctly setup on the manual, you may incorrectly adjust the color settings for the camera.

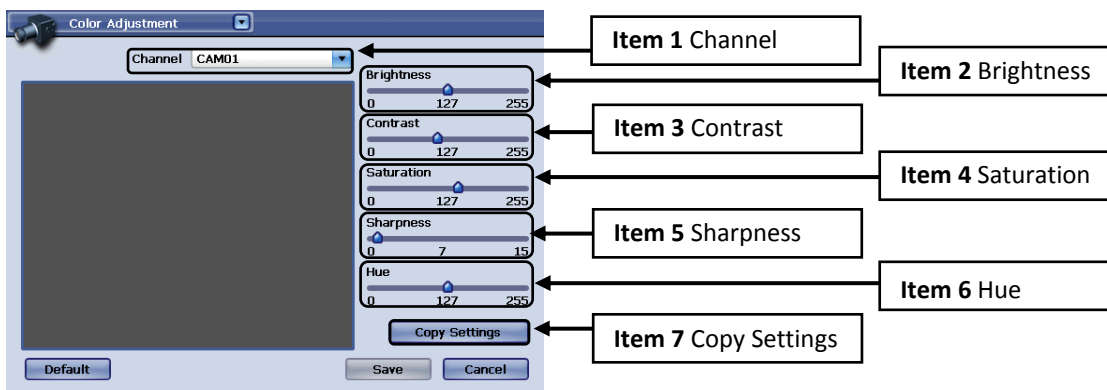

Figure 54 Color Adjustment Window

| | |
|---------------|--|
| ITEM 1 | <p>Channel Select the channel of camera you want to configure by clicking on the drop down list bar</p> |
| ITEM 2 | <p>Brightness To configure brightness slide brightness control slider that controls the brightness.</p> |
| ITEM 3 | <p>Contrast To configure contrast slide contrast control slider that controls the contrast.</p> |
| ITEM 4 | <p>Saturation To configure saturation slide saturation control slider that controls the saturation.</p> |

| | |
|---------------|--|
| ITEM 5 | <p>Sharpness To configure sharpness of the picture slide sharpness control slider that controls the sharpness.</p> |
| ITEM 6 | <p>Hue To configure hue slide hue control slider that controls the hue.</p> |
| ITEM 7 | <p>Copy Setting Upon pressing Copy Setting button, Copy Settings popup will appear. In this popup choose the camera you want to copy from at From drop down list field. Choose the parameters such as Brightness, Contrast, Saturation Sharpness, and Hue by checking on the check box. Check on the check box with camera numbers to apply the copy setting to on TO check box selector section.</p> |

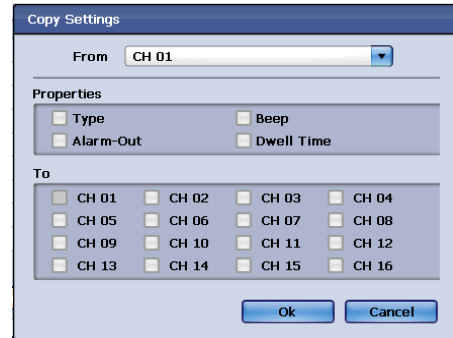

Figure 55 Copy Setting Popup

CHAPTER 12. CAMERA

3. PTZ Camera Configuration

In order for the DVR unit to control the PTZ (Pan Tilt Zoom) type camera you must properly connect the PTZ to the DVR unit.



DO THIS FIRST

Before configuring PTZ camera to the DVR, you must first check following items in order.

Step 1. Check PTZ manual to see what protocol the PTZ camera uses.

Step 2. Check for PTZ ID. Many PTZs have dip type switches that defines the ID number of the PTZ. If there is duplicate ID, you may experience improper movement among PTZs.

Step 3 Make sure that you PTZ device ID starts from 0 or 1. Some PTZs first configurable ID is from 0. If your PTZ starts from ID 0, then set the dipswitch setting to set to have ID 1 or other ID numbers.

Step 4 Check the type of connection your PTZ uses. RS-232 and RS-485 type of connection may be used to connect the PTZ. Check the type and connect it to the proper location marked behind the DVR unit. Chapter XX talks about RS-232 and RS-485.

Step 5 Make sure that your PTZ is not connected together with other controller devices such as PTZ Joystick controllers. Especially, if you are using RS-232 type you may experience communication clash between the DVR unit and Joystick controller unit. Avoid having multiple devices controlling the PTZ camera, this may cause inoperability.

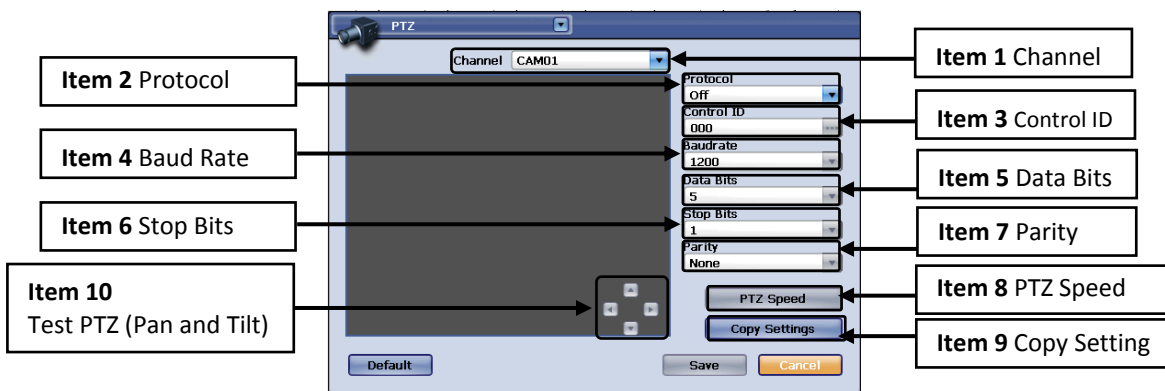
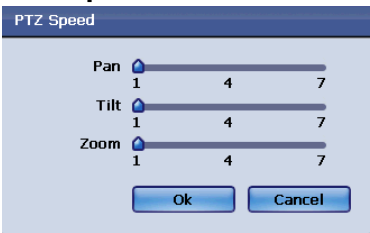

Figure 56

| | |
|---------------|--|
| ITEM 1 | <p>Channel Select the camera channel of the PTZ camera associated with the DVR camera connection input.</p> |
| ITEM 2 | <p>Protocol Select from drop down list, your PTZ camera's protocol setting.</p> |

| | |
|---------------|---|
| ITEM 3 | <p>Control ID This is the section where you input the ID for the PTZ camera. It is very important to have different ID configured to the PTZ cameras.</p> |
| ITEM 4 | <p>Baud Rate This drop down list shows all the possible baud rate configuration option that could be chosen</p> |
| ITEM 5 | <p>Data Bits In this dropdown list bar you may select from 5 to 8 bits. This the length of the bits used to communicate with PTZ and the DVR unit. Consult your PTZ manual to see what bit length your PTZ uses.</p> |
| ITEM 6 | <p>Stop Bits In the dropdown list bar you may choose 1 or 2 for stop bit parameters. They are last bit being used by your PTZ.</p> |
| ITEM 7 | <p>Parity It is check sum bit parameter counted in either 0 or 1.</p> |
| ITEM 8 | <p>PTZ Speed</p>  <ul style="list-style-type: none"> - Pan Speed: 1 ~ 7 - Tilt Speed: 1 ~ 7 - Zoom Speed: 1 ~ 7 <p>To save the setting value, click the "OK" button.</p> |
| ITEM 9 | <p>Copy Setting Upon selecting the Copy Setting button, the Copy Setting popup will appear. This popup will enable you to select the PTZ camera configured, and enables you to copy Items 2 and Items 4~6 mentioned above by giving you the option to check the check box. Select the cameras to copy by using the To section and check the camera numbers.</p> |

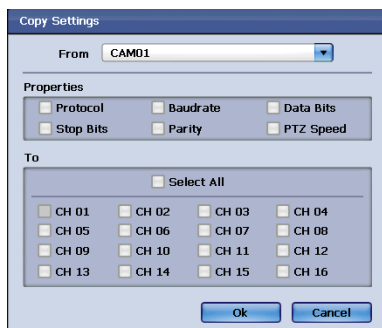

Figure 57 Copy Setting popup for PTZ configuration

| | |
|----------------|--|
| ITEM 10 | <p>Test PTZ (Pan and Tilt) You may use the directional button here to test if your PTZ connection was successful. Upon successful configuration your PTZ should pan and tilt.</p> |
|----------------|--|

CHAPTER 12. CAMERA

4. PTZ Operation

After setting the PTZ configuration you may operate the PTZ via the PTZ popup menu. First you must select the channel in the DVR unit that has PTZ configured and be at Full Screen view.



Figure 58 PTZ Control Panel Bar

On the frontal key pad press [PTZ] button and you will see PTZ tool bar as seen above. (See Figure 58 PTZ Control Panel Bar)

| | | |
|--|-----------|--|
| | WIDE | Used to Zoom In |
| | TELE | Used to Zoom Out. |
| | NEAR | Focus In |
| | FAR | Focus out |
| | OPEN | Open Lens IRIS. |
| | CLOSE | Close Lens IRIS |
| | EXIT | Exit PTZ Control Panel |
| | JOY STICK | Move camera for pan and tilt operation |

Then access the PTZ Control popup menu by right mouse button click or selecting the [Menu] button.

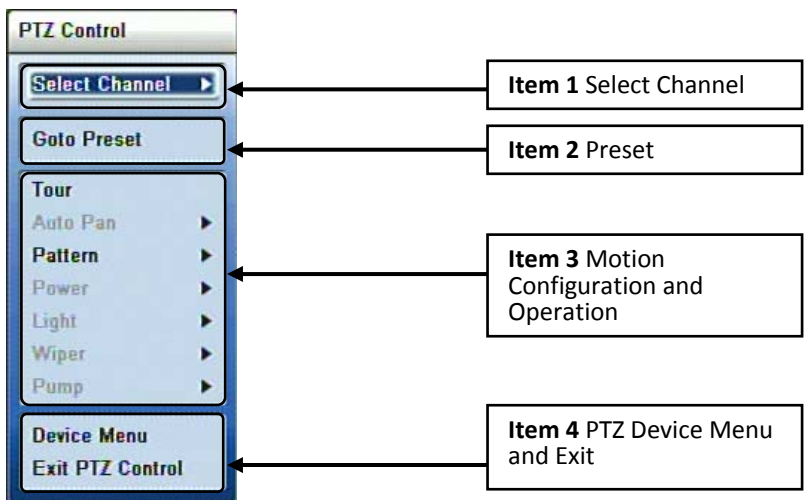

Figure 59 PTZ Control Popup

In this popup menu you may control following options

| | |
|---------------|--|
| ITEM 1 | Select Channel Change to different camera channel from this list item. |
| ITEM 2 | Preset Configuration Here you can view configured preset, configure preset and also delete preset. |



NOTE: About Presets for PTZ
Presets configured will be written to the firmware of the PTZ camera itself (PTZ presets are recorded in to PTZ's memory). If you decide to install the PTZ elsewhere and use the PTZ controllers rather than using the DVR unit to control the PTZ, it will still retain the configured presets for the PTZ. Refer to your PTZ's manual for advanced configuration.

| | |
|---------------|---|
| ITEM 3 | Motion Configuration and Operation Only the supported protocol and the supported PTZ will have some or all option available in this sub list items. |
| ITEM 4 | PTZ Device Menu and Exit |

CHAPTER 12. CAMERA

5. Motion Setup

The motion setup menu is used to configure the various settings for how the DVR will determine what is classified as “motion”. You may specify the sensitivity levels and areas on each camera channel for motion events to be captured.

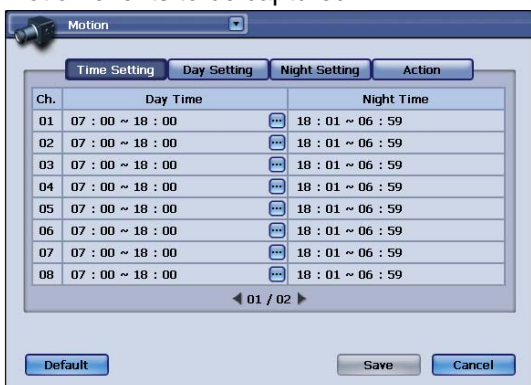
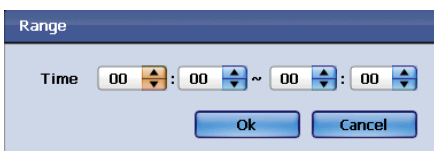

Figure 60

| | |
|---------------|--|
| ITEM 1 | Time Setting Under the “Time Setting” tab, you will notice a “Day Time” setting, and a “Night Time” setting. |
| ITEM 2 | Day Time Once you configure the “Day Time” clock range, the “Night Time” clock range will automatically be updated. To change the “Day Time” setting please click the button located to the right of each channel setting, and you will see the pop-up menu (Figure 61) below to set the time range. |



TIME RANGE SETTING:
After specifying the start and end time range, please click “Ok” to apply the changes, or click “Cancel” to discard them.

Figure 61

To access the other menu options please click on each corresponding menu tab, e.g. “Day Setting”, “Night Setting”, and “Action”. (Figure 60)

Once your desired settings have been made, please click on the “Save” button (Figure 60) to apply the changes. If you desire to discard the changes made to this menu, please click on the “Cancel” button (Figure 60).

To restore the original factory settings, please click on the “Default” button (Figure 60).

You may navigate to any other desired menu by click on the  button located on the top left side of the screen.

Day Setting:

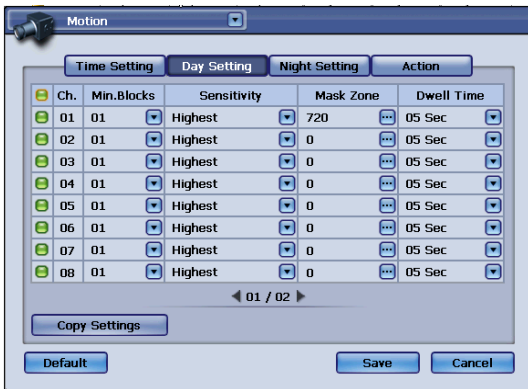



Figure 62



To activate or deactivate each channel, please click on the  button. (Figure 62)

| | |
|---------------|--|
| ITEM 1 | Ch. Specifies the video channel number |
| ITEM 2 | Min. Blocks Specifies the minimum number of blocks to detect for motion in the zone specified. |
| ITEM 3 | Sensitivity There are a total of 5 settings for motion sensitivity, with “Highest” being the most sensitive, and “Lowest” being the least sensitive. |
| ITEM 4 | Mask Zone Is used to specify a zone for motion to be detected for each channel. The area that you specify will be the area where motion will be detected (Please refer to Figure 63 on the next page). |
| ITEM 5 | Dwell Time Is used to specify the post recording duration in seconds (1~99 Seconds) after motion is captured. |

To access the other menu options please click on each corresponding menu tab, e.g. “Day Setting”, “Night Setting”, and “Action”. (Figure 62)

Once your desired settings have been made, please click on the “Save” button (Figure 62) to apply the changes.

If you desire to discard the changes made to this menu, please click on the “Cancel” button (Figure 62).

To restore the original factory settings, please click on the “Default” button (Figure 62).

You may navigate to any other desired menu by click on the  button located on the top left side of the screen.

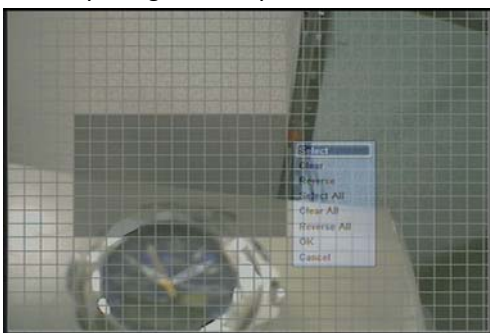

Figure 63

Cell Setup: Please use the mouse cursor to select the starting point of the motion mask. Press the left click button on the mouse to select the first cell. A single click will activate the selected area for motion detection, click the same cell again will deactivate it. The area for motion detection will be in a darker shade.

Block Setup: To select a block of cells, or multiple cells, press the left click button on your mouse, keep it pressed, and drag over the cells you wish to activate. After you let go of the left click button, a pop-up menu will appear giving you multiple options.

Pop-Up Menu: (refer to figure 63)

Select – Will allow you to setup the deactivated area.

Delete – Will allow you to setup the activated area.

Reverse – Will allow you to reverse the current setting, if it is activated, then the reverse option will deactivate the select area.

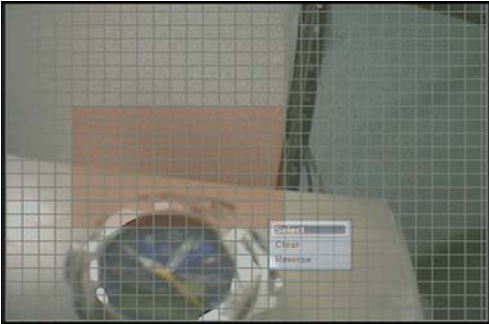

Figure 64

Once you have finished setting up the motion mask zone, press the right click button on your mouse and select “Ok” from the pop-up menu to apply the changes you have made.

Day Setting, Copy Setting, Pop-up Page:

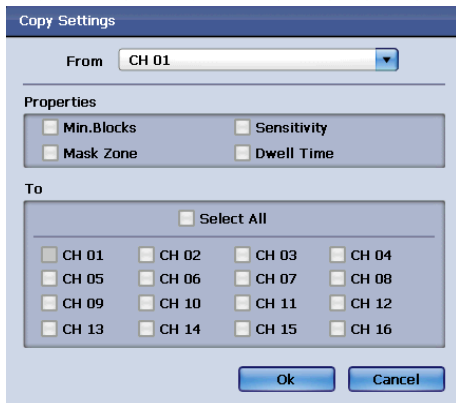

Figure 65

Copy Setting : You may choose to copy the settings from one channel to another, or to other multiple channels.

| | |
|---------------|--|
| ITEM 1 | From – This is the source channel to copy the settings from. |
| ITEM 2 | Properties – These are the attributes you may select to copy from the source channel. |
| ITEM 3 | To – These are the channels that you copy the source channel settings to. |
| ITEM 4 | Ok – Press this button to apply the changes made. |
| ITEM 5 | Cancel – Press this button to discard the changes made. |

Night Setting:

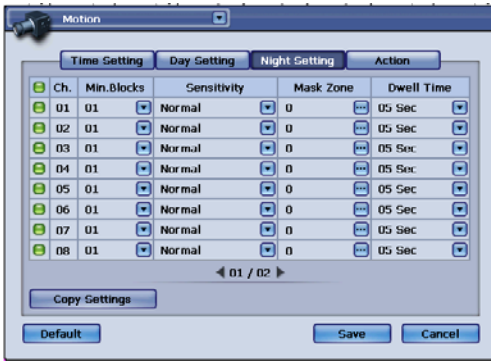

Figure 66



To activate or deactivate each channel, please click on the button. (Figure 66)

| | |
|---------------|---|
| ITEM 1 | Ch. Specifies the video channel number |
| ITEM 2 | Min. Blocks Specifies the minimum number of blocks to detect for motion in the zone specified. |
| ITEM 3 | Sensitivity There are a total of 5 settings for motion sensitivity, with “Highest” being the most sensitive, and “Lowest” being the least sensitive. |
| ITEM 4 | Mask Zone Is used to specify a zone for motion to be detected for each channel. The area that you specify will be the area where motion will be detected. |
| ITEM 5 | Dwell Time Is used to specify the post recording duration in seconds (1~99 Seconds) after motion is captured. |

To access the other menu options please click on each corresponding menu tab, e.g. “Day Setting”, “Night Setting”, and “Action”. (Figure 66)

Once your desired settings have been made, please click on the “Save” button to apply the changes.

If you desire to discard the changes made to this menu, please click on the “Cancel” button.

To restore the original factory settings, please click on the “Default” button.

You may navigate to any other desired menu by click on the button located on the top left side of the screen.

Night Setting, Copy Setting, Pop-up Page:

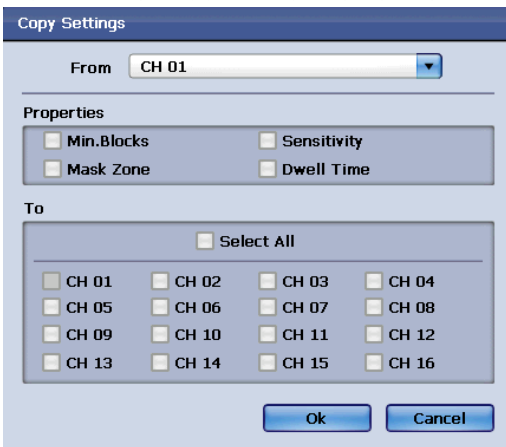

Figure 67

Copy Setting: You may choose to copy the settings from one channel to another, or to other multiple channels.

| | |
|---------------|---|
| ITEM 1 | From – This is the source channel to copy the settings from. |
|---------------|---|

| | |
|---------------|--|
| ITEM 2 | Properties – These are the attributes you may select to copy from the source channel. |
| ITEM 3 | To – These are the channels that you copy the source channel settings to. |
| ITEM 4 | Ok – Press this button to apply the changes made. |
| ITEM 5 | Cancel – Press this button to discard the changes made. |

Action:



Figure 68

| | |
|---------------|--|
| ITEM 1 | Ch. – This represents the “action” number. |
| ITEM 2 | Beep – Check this box if you wish the DVR to make an audible noise when motion is captured. |
| ITEM 3 | Alarm-Out – Select this option to open the “Alarm-Out” pop-up menu to choose which sensor or relay will be activated when motion is detected. (Please refer to figure 68) |

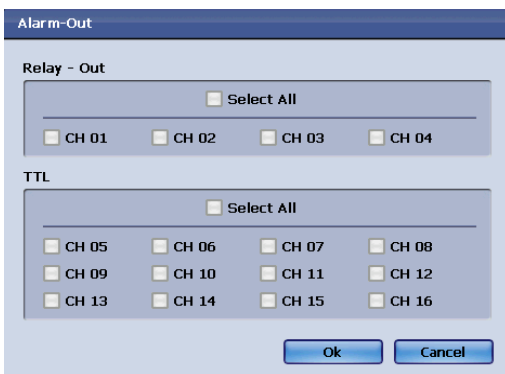



Figure 69 Alarm-Out

To access the other menu options please click on each corresponding menu tab, e.g. “Day Setting”, “Night Setting”, and “Action”.

Once your desired settings have been made, please click on the “Save” button to apply the changes.

If you desire to discard the changes made to this menu, please click on the “Cancel” button.

To restore the original factory settings, please click on the “Default” button.

You may navigate to any other desired menu by click on the  button located on the top left side of the screen.

In this Chapter events such as alarm events, motion events and video loss will be discussed and shown how to be configured.

Configuring Alarm Input

Alarm input is configured in Alarm In window. This window can be accessed by using the quick navigation drop down list from any configuration window.

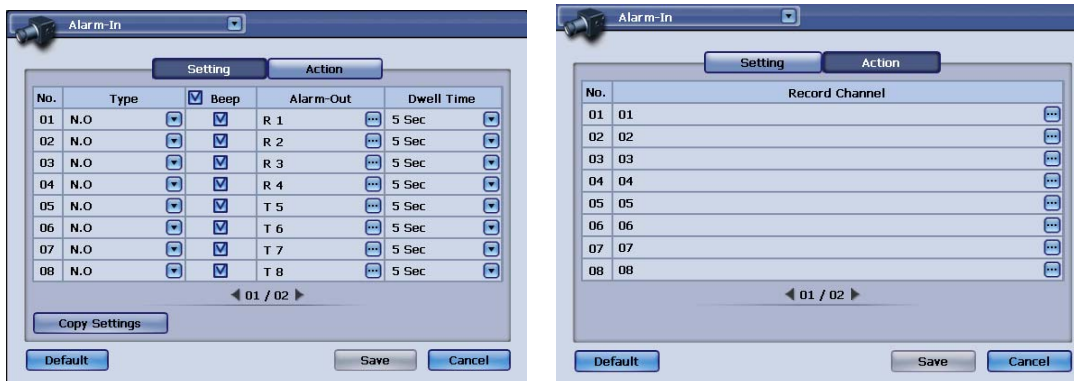

Figure 70 Alarm-In Window

This chapter will cover both record setup and the multiple record schedule options of the DVR. The record setup section details the 4 recording profiles that the DVR supports. You have the option to set Normal, Event, Pre-Alarm, and Panic recording profiles. Record schedules are classified under the Standard Record Schedule type and Holiday Record Schedule type.

CHAPTER 14. RECORD

1. Record Setup

The record menu is used to configure the setup type for each individual camera channel. You may specify resolution, video quality, and frame rate for recording. You will see four profiles for configuring the record setup:

Normal – This profile is used for standard scheduled recording. The settings will be used under normal recording environments.

Event – This profile is used for recording triggered by events like motion triggered or alarm triggered recording. The “Event” record settings will override your “Normal” record settings if a motion or alarm triggered event occurs.

Pre-Alarm – This profile is used to specify the pre-recording type and duration in seconds when either motion or alarm triggered recording occurs. You may specify dwell time (the recorded time allowed pre motion/alarm event) allowed. As well as the type of event, e.g. motion or alarm. These settings will override both “Event” and “Normal” record settings.

Panic – This profile is used to specify the recording type when the “Panic” record button is engaged. The “panic” record button is located on the front panel of the DVR, as well as on the “Live Pop-Up Menu” (accessed by right clicking the live view screen with the mouse). The “panic” record settings will

override both “Event” and “Normal” record settings. The “Pre-Alarm” settings will not be affected because these settings are used for the “pre-event” recording only.

Recording Resolution & Frame Rate: (Normal/Event/Pre-Alarm/Panic)

704x480 (NTSC) @ 30 Frames Per Second Per Channel (All Channels – 1~16)

704x240 (NTSC) @ 30 Frames Per Second Per Channel (All Channels – 1~16)

352x480 (NTSC) @ 30 Frames Per Second Per Channel (All Channels – 1~16)

352x240 (NTSC) @ 30 Frames Per Second Per Channel (All Channels – 1~16)

Configurable Per Channel

Video Quality Settings: (Normal/Event/Pre-Alarm/Panic)

- Highest / High/ Normal/ Low/ Lowest

Configurable Per Channel

Frame Rate Settings: (Normal/Event/Pre-Alarm/Panic)

Each channel can be configured from 1 through 30 frames per second.

Copy Settings: (Normal/Event/Pre-Alarm/Panic)

Use this option to copy the current selected setting to the other settings of each channel

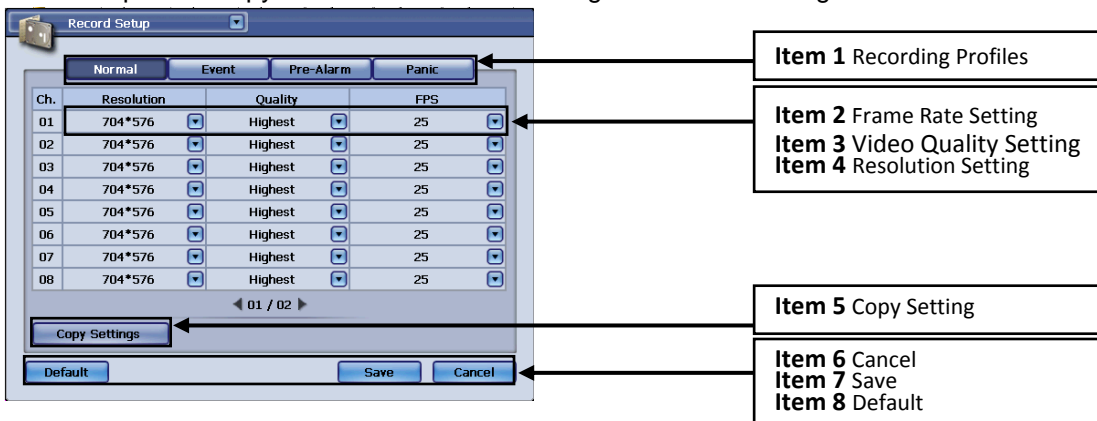

Figure 71 Normal Tab selected

| | |
|---------------|---|
| ITEM 1 | <p>Recording Profiles</p> <p>There are four different recording profile types, Normal, Event, Pre-Alarm, and Panic. Each recording profile has its' own record settings, e.g. Resolution, Quality, and FPS setting. However, the Pre-Alarm profile will have additional settings, e.g. Type and Dwell Time, so that the user may configure the type of Pre-Alarm (Motion, Alarm, Motion + Alarm) and Dwell Time (pre-record buffer-the length in seconds the DVR will record prior to the alarm recording).</p> |
| ITEM 2 | <p>Frame Rate (NTSC: 1,2,5,10,15,30 / PAL:1,2,4,8,12,25)</p> <p>The DVR supports from 1 to 30 frames per second per channel. The frame rate setting is configured by clicking on the drop down menu and selecting desired frame rate.</p> |
| ITEM 3 | <p>Video Quality Setting</p> <p>There are four video quality settings you may choose for each individual camera channel. The options are Highest, High, Normal and Low. This option will adjust the image/video sharpness with Highest being the highest sharpness setting, and Low being the lowest sharpness setting.</p> |
| ITEM 4 | <p>Resolution Setting</p> <p>There are four selectable resolution settings per camera channel. These setting options are: 704x480, 704x240, 352x480, 352x240 (NTSC) 704x576, 704x288, 352x576, 352x288 (PAL) You may select any combination of recording resolution desired for each individual channel.</p> |
| ITEM 5 | <p>Copy Setting</p> <p>The Copy Setting option is used to replicate a particular camera channel setting(s) to the other available camera channels. You have the option to copy all three settings, Resolution, Frame Rate, and Video Quality or each individual setting. The From option is to select which camera channel to copy the setting(s) from, and the To option is to select which camera channel(s) to replicate the settings to. The Copy Setting can be used for each of the four Recording Profiles.</p> |

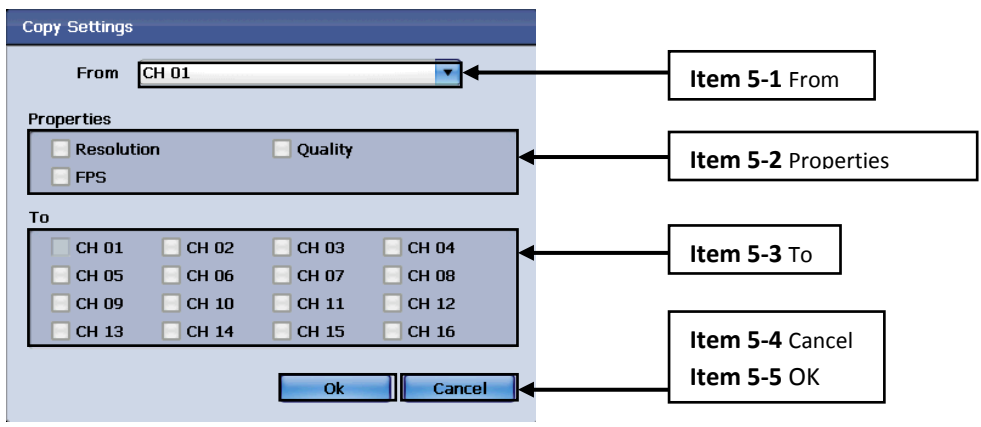

Figure 72

| | | |
|---------------|--|---|
| ITEM 5 | 5 -1 | From The FROM option is the source channel to copy the setting from. |
| | 5 -2 | Properties The PROPERTIES selection box are the optional attributes to copy from the source channel. |
| | 5 -3 | To The TO selection box are the channels you wish to copy the source attributes to. |
| | 5 -4 | Cancel The CANCEL button will discard all settings made and will close the current window. |
| | 5 -5 | OK The OK button will apply the changes made to this configuration window. |
| ITEM 6 | Cancel The cancel button will discard all changes made and close the current window. | |
| ITEM 7 | Save The save button will apply all changes made to this configuration menu. | |
| ITEM 8 | Default The default button will restore all factory default settings to this configuration menu. | |

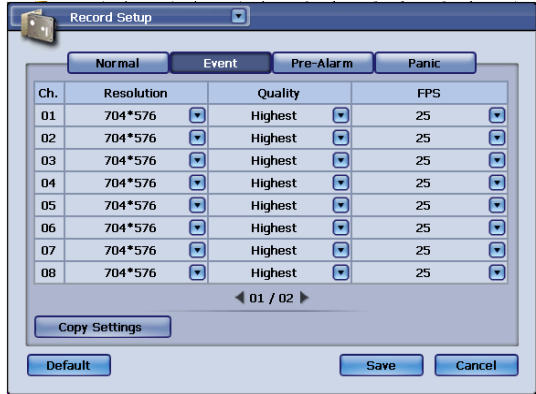

Figure 73 Event Tab Selected

Event – This profile is used for recording triggered by events like motion triggered or alarm triggered recording. The “Event” record settings will override your “Normal” record settings if a motion or alarm triggered event occurs. The options for **RESOLUTION, QUALITY, FPS, COPY SETTINGS, DEFAULT, SAVE, AND CANCEL** are the same as the **NORMAL** record settings.

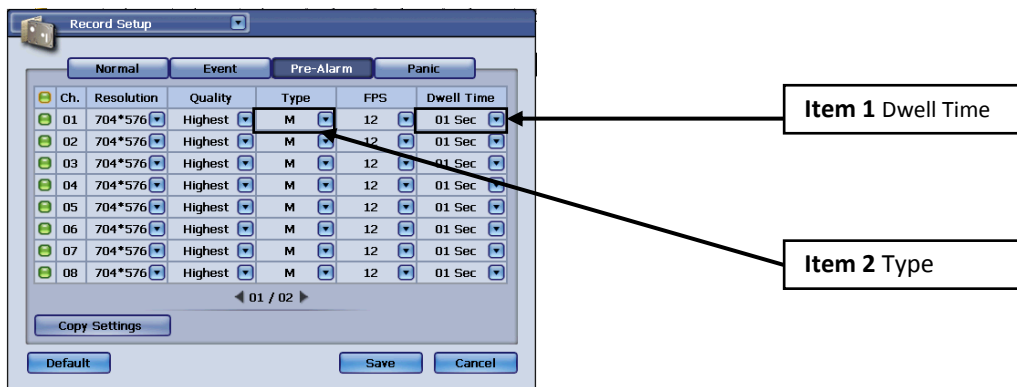

Figure 74 Pre-Alarm Tab Selected

Pre-Alarm – This profile is used to specify the pre-recording type and duration in seconds when either motion or alarm triggered recording occurs. You may specify dwell time (the recorded time allowed pre motion/alarm event) allowed. As well as the type of event, e.g. motion or alarm. These settings will override both “Event” and “Normal” record settings. The options for **RESOLUTION, QUALITY, FPS, COPY SETTINGS, DEFAULT, SAVE, AND CANCEL** are the same as the **NORMAL** record settings. However the two additional options for this menu are:

| | |
|---------------|--|
| ITEM 1 | <p>Dwell Time</p> <p>The DWELL TIME option is used to specify the post recording duration in second(s). This will determine how long the recording will run for the specified channel after the PRE-ALARM is triggered.</p> |
| ITEM 2 | <p>Type</p> <p>The TYPE option is used to specify which pre-alarm trigger to use, e.g. MOTION OR ALARM.</p> |



Figure 75 Panic Tab Selected

Panic – This profile is used to specify the recording type when the “Panic” record button is engaged. The “panic” record button is located on the front panel of the DVR, as well as on the “Live Pop-Up Menu” (accessed by right clicking the live view screen with the mouse). The “panic” record settings will override both “Event” and “Normal” record settings. The “Pre-Alarm” settings will not be affected because these settings are used for the “pre-event” recording only. The options for **RESOLUTION, QUALITY, FPS, COPY SETTINGS, DEFAULT, SAVE AND CANCEL** are the same as the **NORMAL** record settings.

CHAPTER 14. RECORD

2. Standard Record Schedule

The record schedule menu is used to configure specific date and times for the DVR to record. You may use multiple schedule configurations in this menu to meet the demands of your recording needs. Individual channels may be configured.

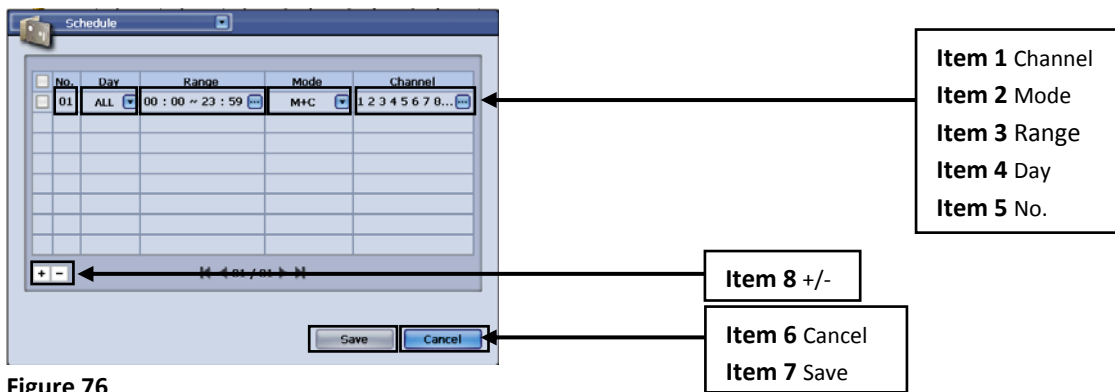

Figure 76

| | |
|---------------|--|
| ITEM 1 | Channel Use this option to select the desired channels for Record Schedule configuration. You may select each individual channel, a group of channels, or all channels to apply the record settings to. |
| ITEM 2 | Mode There are five mode types to choose from; Alarm, Motion, Continue, A + M (Alarm + Motion), and M + C (Motion + Continue). This setting will determine what type of mode to enable for recording. |
| ITEM 3 | Range The range option is to set the desired time to enable recording. |
| ITEM 4 | Day The day option is to set the desired day(s) to enable recording (The “ALL” setting may be used to configure all 7 days of the week). |
| ITEM 5 | No. This represents the schedule entry number. Please check the box on the left side of the No. (number) before choosing to remove the entry. |
| ITEM 6 | Cancel The cancel button to discard the changes made to these settings and will close the window. |
| ITEM 7 | Save The save button will apply the changes made to this configuration menu. |
| ITEM 8 | - / + Check the desired entry(s) then press – to remove it. If you wish to add an entry(s), press the + key to do so. |

- : Press this button to go to the first page : Press this button to go to the previous page

- : Press this button to go to the next page : Press this button to go to the last page

Once your desired settings have been made, please click on the “Save” button to apply the changes.

If you desire to discard the changes made to this menu, please click on the “Cancel” button.

To restore the original factory settings, please click on the “Default” button.

You may navigate to any other desired menu by click on the button located on the top left side of the screen.

Range:

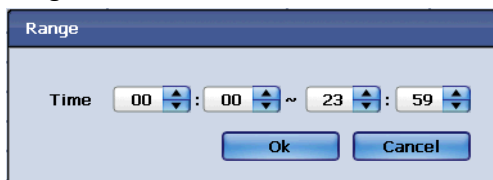

Figure 77

| | |
|---------------|--|
| ITEM 1 | Time – You can specify the start and end time here. |
| ITEM 2 | Ok – Press this button to save the settings. |
| ITEM 3 | Cancel – Press this button to discard the changes made. |

Channel:

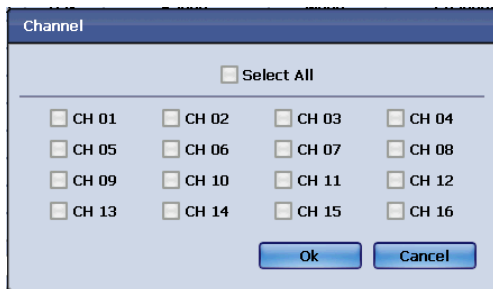

Figure 78

| | |
|---------------|--|
| ITEM 1 | Select All – Press this button to select all channels. |
| ITEM 2 | CH 01 ~ CH 16 – You can choose individual channels for recording. |
| ITEM 3 | Ok – Press this button to save the settings. |
| ITEM 4 | Cancel – Press this button to discard the changes made. |

CHAPTER 14. RECORD

3. Holiday Schedule

The Holiday Schedule is used to specify certain holidays' throughout the calendar year. This setting may be used to make exceptions to the recording schedule due to holiday hours and days of operation during these times.

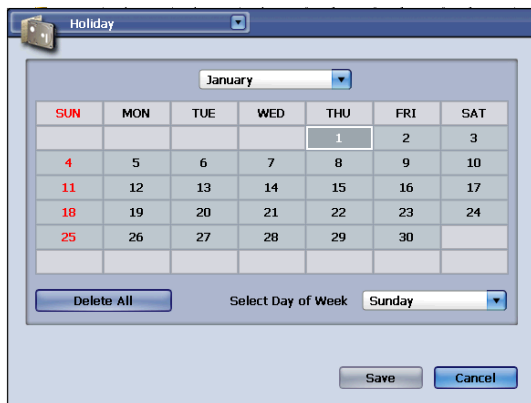

Figure 79

Once you click on a specified date, a pop-up menu will appear (refer to figure 80)



Figure 80

To verify the Holiday schedule, please check the box accordingly. Then press "Ok" to save the setting, or press "Cancel" to discard the changes made. If the changes were successfully the color of the pop-up menu will appear in a different color.

Delete All – By pressing this button, you can delete all holiday schedules. Once you press this button, a pop-up menu will appear (refer to figure 79)

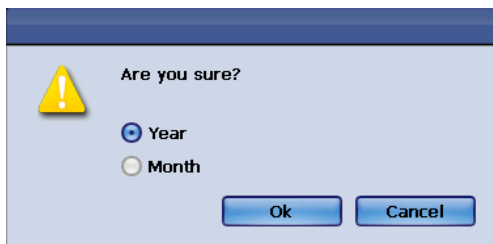



Figure 81

| | |
|---------------|--|
| ITEM 1 | Year – Choose this option to delete all holiday schedules for the year. |
| ITEM 2 | Month – Choose this option to delete all holiday schedules for the month. |
| ITEM 3 | Ok – Press this button to confirm the action. |
| ITEM 4 | Cancel – Press this button to discard the action. |

Select Day of Week – The standard holiday is Sunday, but you may choose what day to specify. Once your desired settings have been made, please click on the “Save” button to apply the changes. If you desire to discard the changes made to this menu, please click on the “Cancel” button. To restore the original factory settings, please click on the “Default” button.

You may navigate to any other desired menu by click on the  button located on the top left side of the screen.

CHAPTER 14. RECORD

4. Search & Playback

The search and playback menus are used to review the recorded video data on the DVR. There are multiple search options you may use to find the desired video you wish to view. The following are the search queries you may use:

Date/Time Search

This option allows you to access specific recorded video data by Year, Month, Day, Hour, Minute, and Second.

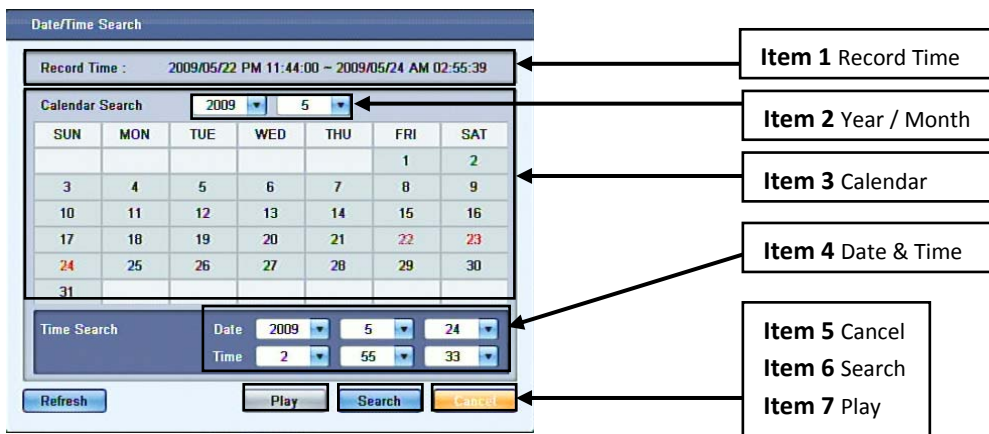

Figure 82

| | |
|---------------|--|
| ITEM 1 | Record Time The record time section displays the entire recorded video database represented by a time range, from the earliest available recording to the most current available recording. |
| ITEM 2 | Year / Month The year and month option is used to display or navigate to the desired calendar date with recorded video data. Select the drop down menu to jump to specify the year and month. |

| | |
|---------------|--|
| ITEM 3 | <p>Calendar</p> <p>The calendar will display the days for the selected year and month. Days with recorded video data will be shown in bolded red color font. Select the desired day with recorded video data, and then press search (item 6).</p> |
| ITEM 4 | <p>Date and Time</p> <p>Use the date and time option to jump to the desired section of recorded video data. You are able to choose the year, month, day, hour, minute and second.</p> |
| ITEM 5 | <p>Cancel</p> <p>The cancel button is used to close the search window.</p> |
| ITEM 6 | <p>Search</p> <p>Search (item 6) is used to open the hour selection menu.</p> |

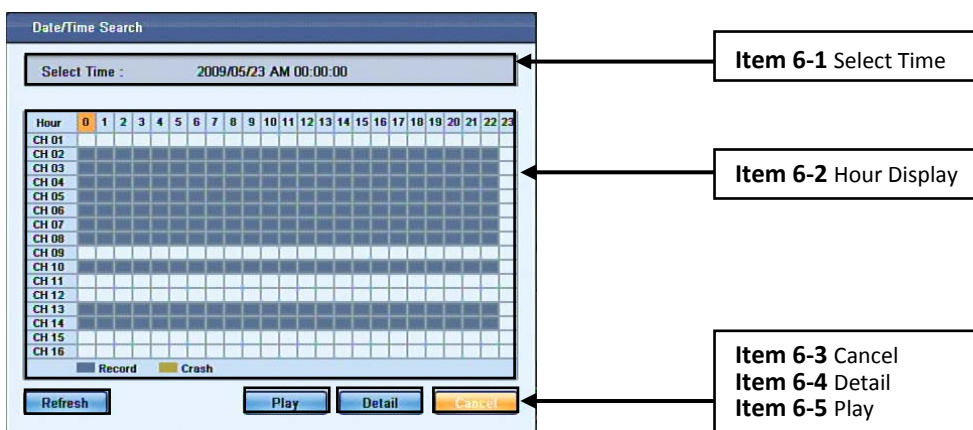

Figure 83

| | | |
|---------------|-------------|--|
| ITEM 6 | 6 -1 | <p>Select Time</p> <p>The select time will display the date and time specified by the user.</p> |
| | 6 -2 | <p>Hour Display</p> <p>The hour display will show the available recorded video data on the DVR for the specified date. The color indicator represents the following:</p> <ul style="list-style-type: none"> Red – Panic Recording Orange/Yellow – Alarm Recording Green – Motion Recording Purple – Pre-Alarm Recording Blue – Continuous Recording |
| | 6 -3 | <p>Cancel</p> <p>The cancel button is used to close the current search window</p> |
| | 6 -4 | <p>Detail</p> <p>The detail button will open the minute search setting. The minute and search window is used to specify which minute you wish to review for the selected hour.</p> |

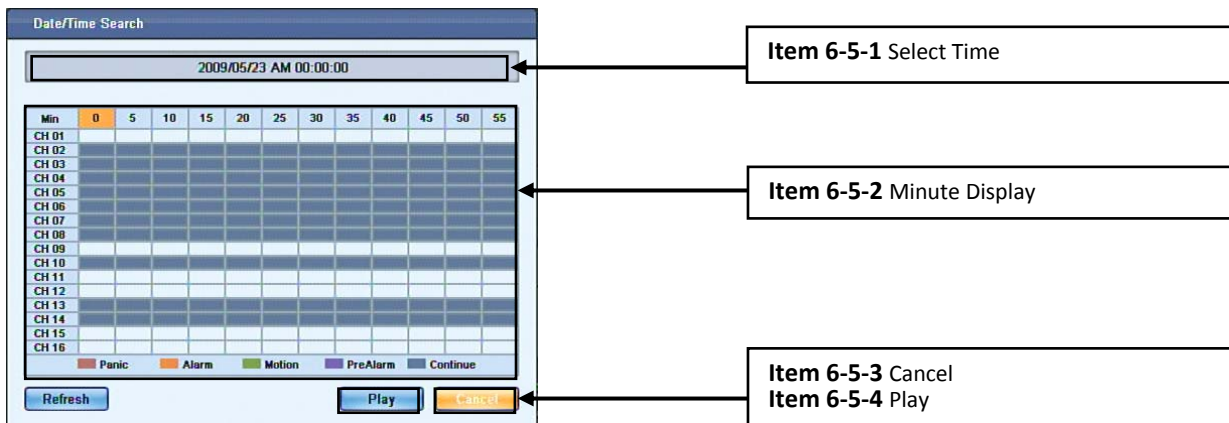

Figure 84

| | | | |
|---------------|--|----|---|
| ITEM 6 | 6 -5 | -1 | Select Time The select time will display the date and time specified by the user. |
| | | -2 | Minute Display The minute display section will show the available recorded video data in minutes. |
| | | -3 | Cancel The cancel button will close the current search window. |
| | | -4 | Play Press the play button to begin playback of the recorded video data by the selected minute of the selected hour. |
| ITEM 7 | Play The play button will begin playback of the recorded video by the selected date and time. | | |

CHAPTER 14. RECORD

5. Event Search

This option allows you to search specific recorded data by “Event”. “Events” are classified as **Panic, Alarm, Motion, Video Loss**. “Event Search” allows a faster search method if the user prefers to view only “Event” recordings.

Panic

Panic recording is a type of recording engaged by pressing the “Panic” button on the frontal keypad of the DVR, or by the OSD (On Screen Display). “Panic” record is also referred to as “Forced Recording”.

Alarm

Alarm recording is a type of recording that is triggered by sensors connected to the alarm panel of the DVR. Motion, IR, and heat sensors are just a few examples of the possible sensors that can be used to trigger recordings.

Motion

Motion recording is a type of recording that is triggered by the motion captured events on the DVR.

Video Loss

Video Loss indicates the moment that a video loss happened.

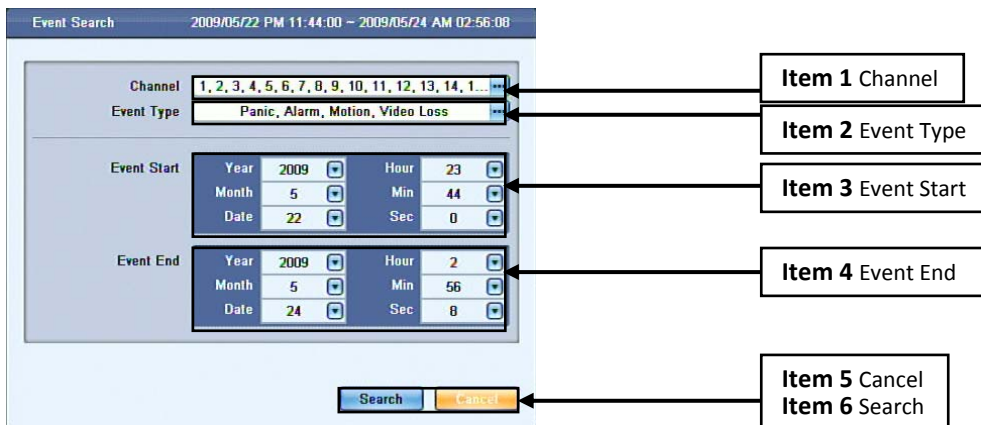

Figure 85

| | |
|---------------|--|
| ITEM 1 | <p>Channel</p> <p>Use this option to select the desired channels for event playback. You may choose an individual channel, a group of channels, or all channels.</p> |
| ITEM 2 | <p>Event Type</p> <p>The event type option is used to choose what type of events you wish to search for. The options for the type of events are: Panic / Alarm / Motion / Video loss You may choose an individual event type.</p> |
| ITEM 3 | <p>Event Start</p> <p>The event start is used to select a start time for the DVR to search for the specified events. You can specify both date and time.</p> |
| ITEM 4 | <p>Event End</p> <p>The event end is used to select the end time for the DVR to search for the specified events. You can specify both date and time.</p> |
| ITEM 5 | <p>Cancel</p> <p>The cancel button is used to close the current search window.</p> |
| ITEM 6 | <p>Search</p> <p>The search button is use to initiate the event search process. By pressing the search button this will open the event search list window below.</p> |

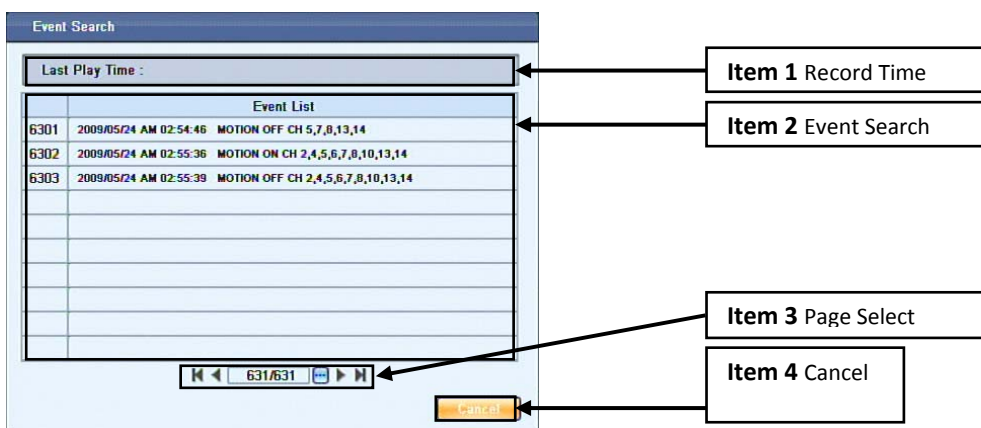

Figure 86

| | |
|---------------|---|
| ITEM 1 | <p>Record Time</p> <p>The record time is an indicator that displays the date range for the recorded events.</p> |
| ITEM 2 | <p>Event Search</p> <p>The recorded events will be displayed in this section. Each event will be displayed with the camera number, type of event, and date/time stamp.</p> |

| | |
|---------------|--|
| ITEM 3 | Page Select This section will allow the user to go to the next page, or you can jump to a desired page directly by pressing the ... button. You can then specify a page number to jump to. |
| ITEM 4 | Cancel Press the cancel button to close the current search window. |
| ITEM 5 | Search The search button will begin the playback process for the selected event. |

CHAPTER 14. RECORD

6. Motion Search

The Motion Search option is a smart search function that allows users to search for recorded data by specifying motion zone masks. Motion Search enables motion zone masks to be selected in a video window which in turn the DVR uses to query its' recorded video database for motion events to be displayed for playback.

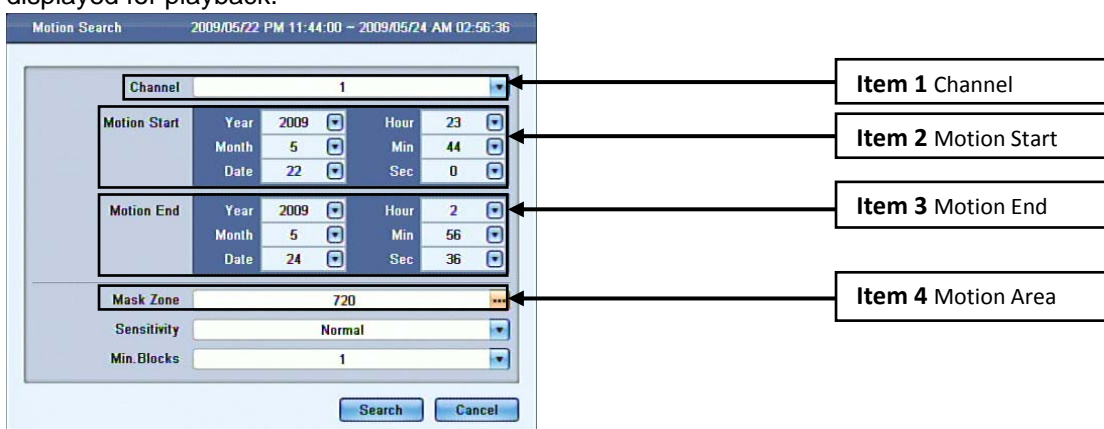

Figure 87

| | |
|---------------|--|
| ITEM 1 | Channel By pressing the drop down menu, you are able to select the desired channel to begin the motion search option. |
| ITEM 2 | Motion Start The motion start option is used to specify a start date for motion search. |
| ITEM 3 | Motion End The motion end option is used to specify a end date for motion search. |
| ITEM 4 | Motion Area The motion area option is engaged by pressing the ... button located on the right side. Once clicking on the ... button, the motion area grid window for the specified camera channel will open. You are now able to select a desired area on the motion grid by using the left mouse button for which you want to search for motion events. Any motion triggered events in the drawn area will be listed. |

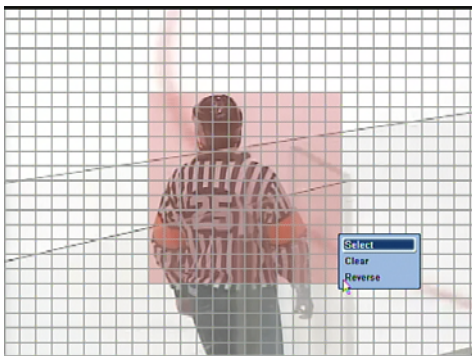

Figure 88

Motion Mask by Mouse

To draw a motion mask in the desired zone, use the mouse and hold down the left click button and drag it to the end point of the desired mask zone area. Once you let go of the left click button the zone will be drawn in red. A pop-up menu will now appear, confirm the zone by choosing “**select**”. The “**reverse**” option will select the chosen mask zone in reverse. And “**clear**” will deselect the chosen mask zone area. After the desired mask area is selected, right click the mouse again and choose the “**ok**” button from the pop-up menu to confirm the area for motion search. You will now be back at the main Motion Search page. Click on the “**search**” button to begin the motion search.

Motion Mask by Frontal Keypad

To draw a motion mask in the desired zone, use the directional keypad on the frontal keypad of the DVR. To select a block, press the **enter** key located next to the **directional keypad**. To deselect the block, press the **enter** key again. Press the **menu** key on the frontal keypad to bring up the pop-up menu to confirm or cancel the mask setting.

Once the search has begun you will now see the **Motion List** window shown below. All the motion events captured by the DVR will now be displayed in the **motion list**. To view the motion event, select the desired item from the list and it will be played back on the video window on the left side of motion list.

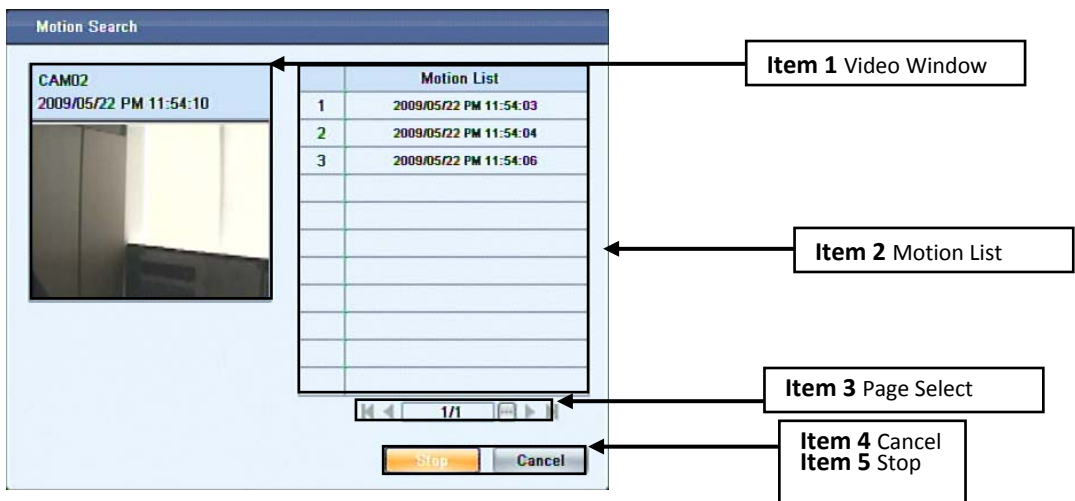

Figure 89

| | |
|---------------|---|
| ITEM 1 | View Window The video window displays the selected motion event from the motion list . |
| ITEM 2 | Motion List The motion list displays all motion events found from the search criteria specified on the previous page (motion search). |
| ITEM 3 | Page Select The page select function allows you to go to the next page or jump to a specific page by pressing the ... button and entering the desired page number. |
| ITEM 4 | Cancel The cancel button will close the current search window. |
| ITEM 5 | Stop The stop button will cease the search query and stop the further population of events on the motion list . |

CHAPTER 14. RECORD

7. Bookmark Search

Book mark search allows the user to search for recorded video data by the indicators (book marks) placed during playback. While reviewing recorded video data, you are able to place book marks by clicking “b. mark” from the pop-up menu, or by pressing “B. Mark” from the frontal keypad. To access the book mark search function, right click the live view screen with your mouse and choose **search** than **book mark**. From the front keypad, press **search** than choose **book mark**. The following window will be displayed.

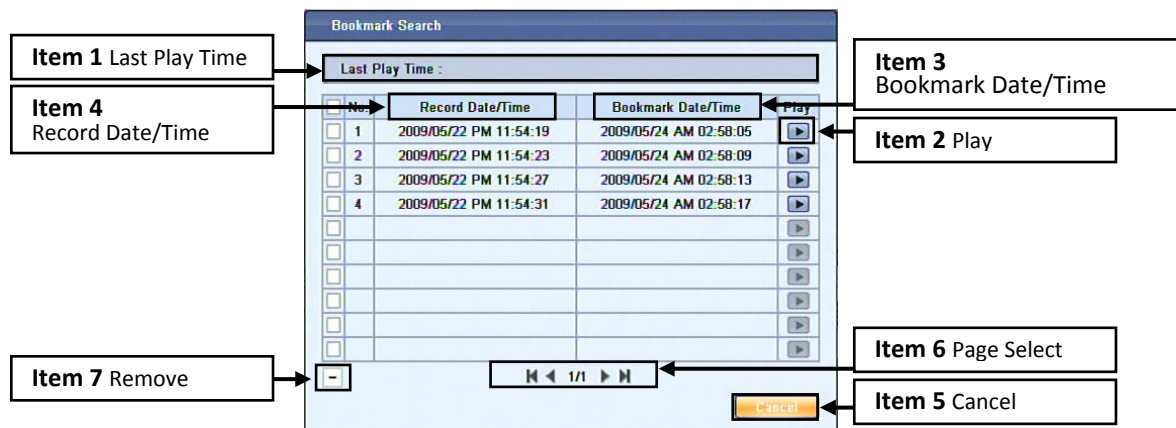

Figure 90

| | |
|---------------|--|
| ITEM 1 | Last Play Time The last play time indicates the latest playback time of a bookmark. |
| ITEM 2 | Play The play button begins the playback function of the selected bookmark. |
| ITEM 3 | Bookmark Date/Time This list shows date and time at which the book mark was created. |
| ITEM 4 | Record Date/Time This list shows the actual date and time from which the corresponding bookmark was created. |
| ITEM 5 | Cancel This button closes the current search window. |
| ITEM 6 | Page Select This function is used to go to the next page, or you may jump to a specific page by pressing the ... button and entering the page number. |
| ITEM 7 | Remove This option enables you to remove the selected bookmark listed. Make sure to check the box next to the corresponding bookmark on the list before removing it. |

The Device chapter will cover **Hard Drive Clear, CD/DVD/USB Back Up, RS-232C, RS-485, Smart Backup and Remote Control** configuration options and procedures. These features must be properly configured so that functionality of the corresponding devices may operate properly. A thorough understanding of these functions and ports are recommended for better operation of the DVR and third party devices.

CHAPTER 15. DEVICE

1. HDD Clear

The Hard Drive Clear menu not only displayed HDD information but provides 3 options for the hard disk drive of the DVR. The HDD Clear function is not only used to format (delete) all recorded video data located on the DVR, but also is performed after a firmware update is applied.

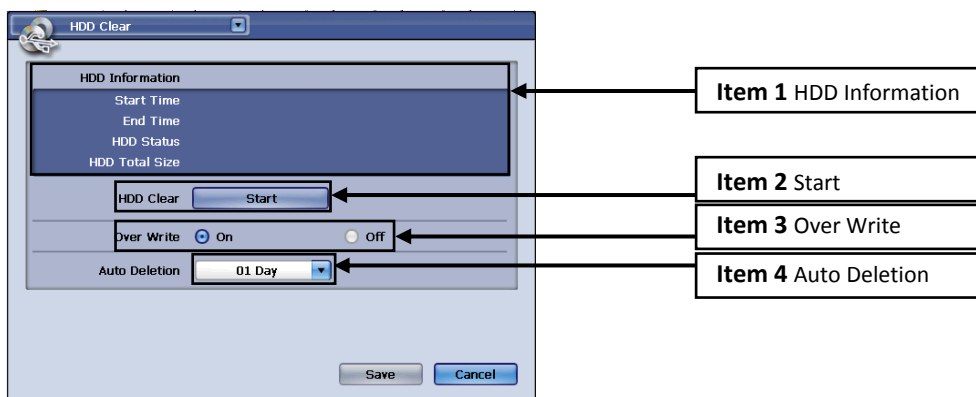

Figure 91

| | |
|---------------|---|
| ITEM 1 | <p>HDD Information</p> <p>The HDD Information section displays the current status of the drive. The indicators are as follows:</p> <p>Start Time – The earliest available recorded video data on the hard drive indicated by the date and time.</p> <p>End Time – The most current available recorded video data on the hard drive indicated by the date and time.</p> <p>HDD Status – The location of the hard drive, e.g. S-ATA MASTER 1, 2, 3, OR 4. This section also indicates the type of hard drive.</p> <p>HDD Total Size – This section will display the total physical size of the hard drive in Gigabytes.</p> |
| ITEM 2 | <p>Start</p> <p>The start button will begin the hard drive clear process. Once the hard drive is cleared, all recorded data will be no longer available.</p> |
| ITEM 3 | <p>Over Write</p> <p>There are two options for the over write function, ON or OFF. Setting the over write option to the ON position will enable the DVR to over write the hard drive starting from the earliest date of recording once the hard drive is at 100% capacity. Setting this option to the OFF position will cause the DVR to stop recording once the drive is at 100% capacity.</p> |
| ITEM 4 | <p>Auto Deletion</p> <p>This function allows the DVR to automatically format the hard disk at a specified time. The time options are from 1 to every 99 days.</p> |

CHAPTER 15. DEVICE

2. CD/DVD/USB Back up

There are two options for recorded video data back up from the DVR, CD/DVD-RW drive and USB memory stick. A third back up option is available via our CMS (Central Monitoring Software) and Remote Client Software (Network Back Up). The details of our CMS and Remote Client back up will be further discussed in the Remote Client chapter of this manual.

CD/DVD-RW Back Up

The DVR is compatible with S-ATA (Serial ATA) DVD/RW-CD/RW drives. The media that you may use are 4.7GB DVD-R and 700MB CD-R blank discs or what is determined as compatible with the CD/DVD-RW drive from the manufacturer. Please insert the blank CD-R or DVD-R into the drive before

beginning the back-up procedure. To insert the disc, press the **open** key  located above the drive bay. Once this key is pressed, the media tray will be ejected from the drive. You may now place the disc in the tray and press the **open** key again to close it. Once the blank media is properly inserted navigate to the **Back-Up** menu.

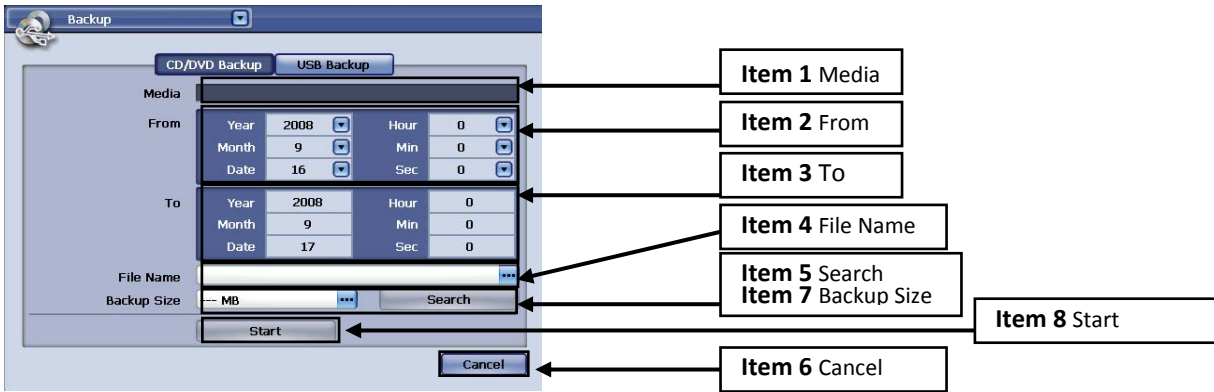

Figure 92

| | |
|---------------|---|
| ITEM 1 | <p>Media</p> <p>The media section of this menu will display the disc information of the blank media loaded in the CD/DVD-RW drive. The size available for back up will be noted in this section. If the media fails to load this section will state: “Initializing Media Success”, if it fails it will state, “Initializing Media Failed”.</p> |
| ITEM 2 | <p>From</p> <p>The from section is used to select the start date and time for back up. You can specify the year, month, day, hour, minute, and second by clicking on the drop down arrow located next to each selection.</p> |
| ITEM 3 | <p>To</p> <p>The to section is used to show the end date and time for back up. It is specified by the backup size which you entered in ITEM 7.</p> |
| ITEM 4 | <p>File Name</p> <p>You are able to specify the file name for the backup file in this section. Click on the ... key to bring up the on screen keyboard.</p> |
| ITEM 5 | <p>Search</p> <p>The search button is used to confirm that the specified date range is available for backup. If the date and time specified is not available, the closest date and time available to the specified date and time will be selected.</p> |
| ITEM 6 | <p>Cancel</p> <p>The cancel button will close the current window and cancel all changed settings in this section.</p> |

| | |
|---------------|--|
| ITEM 7 | <p>Back Up Size</p> <p>This section can be used to specify a maximum back up size. The size will be set in megabytes. After selecting the backup size, the to date and time will be adjusted automatically according to the backup size you specify. *Notice: Minimum backup size is 100MB.</p> |
| ITEM 8 | <p>Start</p> <p>The start button will begin the backup process. You may cancel the back-up procedure by clicking on cancel.</p> |

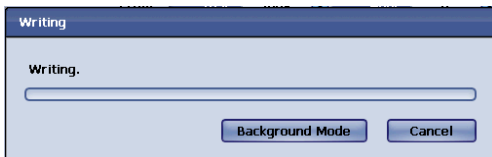
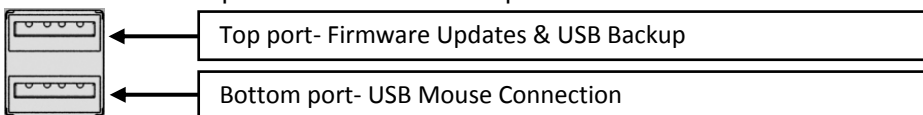

Figure 93

USB Back Up

The DVR supports USB memory stick back up via the USB 2.0 port located on the front side of the DVR. There is one USB port available for back up.



The following are the supported densities using a USB Memory stick for back up:

1. 256MB (Megabyte)
2. 512MB (Megabyte)
3. 1GB (Gigabyte)
4. 2GB (Gigabyte)

To begin the back-up procedure using a USB memory stick, please insert it into the available USB port located on the front panel of the DVR. Once inserted, navigate to the USB back-up menu.

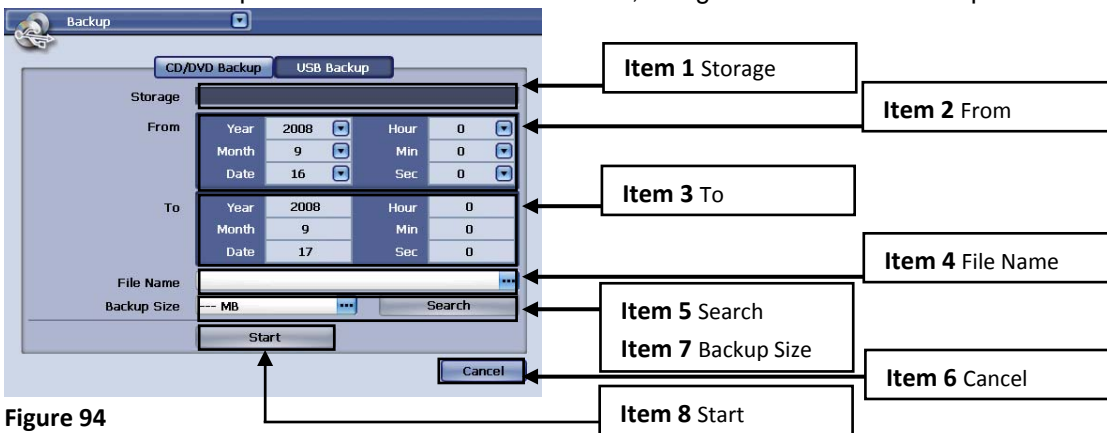

Figure 94

| | |
|---------------|--|
| ITEM 1 | <p>Storage</p> <p>The storage section of this menu will display the USB media information. The size available for back up will be noted in this section. If the media fails to load this section will state: “Initializing Media Success”, if it fails it will state, “Initializing Media Failed”.</p> |
| ITEM 2 | <p>From</p> <p>The from section is used to select the start date and time for back up. You can specify the year, month, day, hour, minute, and second by clicking on the drop down arrow located next to each selection.</p> |
| ITEM 3 | <p>To</p> <p>The to section is used to show the end date and time for back up. It is specified by the backup size which you entered in ITEM 7.</p> |
| ITEM 4 | <p>File Name</p> <p>You are able to specify the file name for the backup file in this section. Click on the ... key to bring up the on screen keyboard.</p> |

| | |
|---------------|--|
| ITEM 5 | <p>Search</p> <p>The search button is used to confirm that the specified date range is available for backup. If the date and time specified is not available, the closest date and time available to the specified date and time will be selected.</p> |
| ITEM 6 | <p>Cancel</p> <p>The cancel button will close the current window and cancel all changed settings in this section.</p> |
| ITEM 7 | <p>Back Up Size</p> <p>This section can be used to specify a maximum back up size. The size will be set in megabytes. After selecting the backup size, the to date and time will be adjusted automatically according to the backup size you specify. *Notice: Minimum back size is 100MB.</p> |
| ITEM 8 | <p>Start</p> <p>The start button will begin the backup process. You may cancel the back-up procedure by clicking on cancel.</p> |



Figure 95



Notice!

1. If there is any time-overlapped data (ex: DST etc.) among the recorded data you want to back up, the window which you can select the one of time-overlapped data will pop up and "Search"(ITEM5) will be done according to the selected data.
2. When the DVR is under HDD overwriting mode, back up can be done from the data of more then 1 hour later of "Recorded start time"

(Because when the overwriting is on working, the "Recorded start time" is changing continuously)

CHAPTER 15. DEVICE

3. RS-232C

The RS-232C port has two main functions, PC to DVR update using a DB9 cable, and PTZ control using a RS-485 to RS-232C adapter. The settings required for both functions vary depending on the devices specifications. Please refer to the devices operational manual for the required baud rate, data bits, stop bit, and parity settings to establish communication between devices.

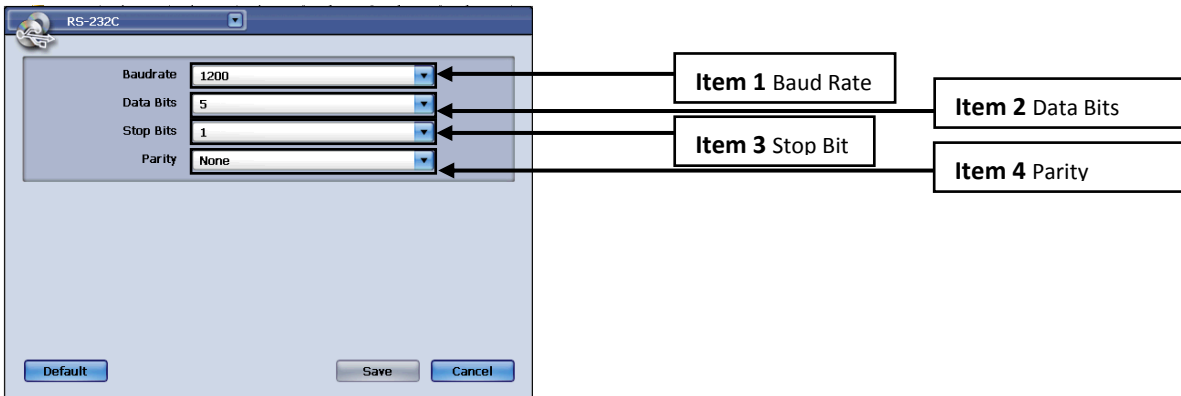

Figure 96

| | |
|---------------|--|
| ITEM 1 | <p>Baud Rate</p> <p>The baud rate setting is used to determine the speed setting between the DVR and external device using the RS-232C port. The RS-232C port uses two voltage states commonly known as MARK (negative) and SPACE (positive). The baud rate will vary depending on the required settings of the external device used with the RS-232C port. Please refer to the operational manual of the device.</p> |
| ITEM 2 | <p>Data Bits</p> <p>The data bit setting is used to determine the order of transmission for the least significant bit (LSB) to the most significant bit (MSB). The optional settings are from 5 to 8 bits.</p> |

| | |
|---------------|---|
| ITEM 3 | <p>Stop Bit</p> <p>The stop bit setting determines the last part of the data frame. These bits are always represented by a negative voltage and will determine when data transmission will cease. The options for the stop bits are 1, 1.5, and 2 bits.</p> |
| ITEM 4 | <p>Parity</p> <p>The parity bit is used as a simple method of error checking. This option specifies whether the parity of the transmission will be None, Odd, or Even bits. Suppose the parity is chosen to be odd. The transmitter will then set the parity bit in such a way as to make an odd number of 1's among the data bits and the parity bit.</p> |

CHAPTER 15. DEVICE

4. Keyboard Control (RS-485)

The keyboard control port is located on the rear panel of the DVR next to the PTZ controller input pins. The keyboard control pins are labeled as **KBD**. This port is used for external DVR control devices (optional). The external DVR control device is used as an alternative method to operate the DVR. Please contact the vendor or distributor you purchased the DVR from to inquire about the detailed specifications and usage of the external controller. This section will discuss settings used by this feature.

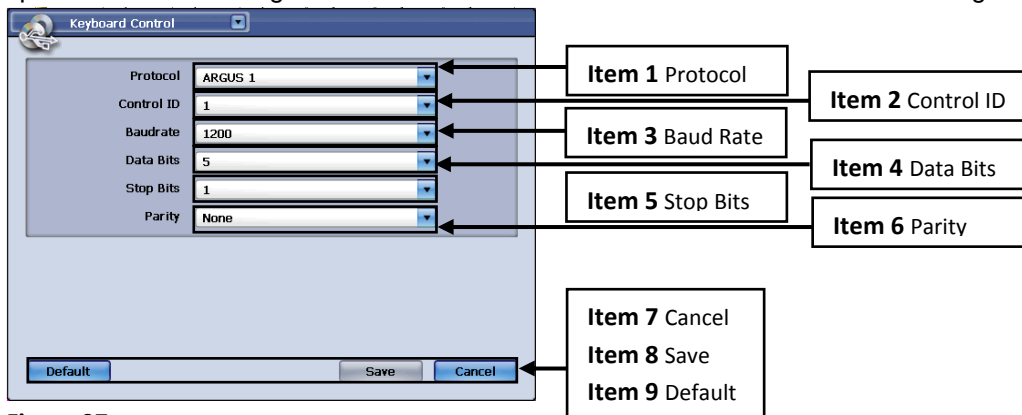

Figure 97

| | |
|---------------|---|
| ITEM 1 | <p>Protocol</p> |
| ITEM 2 | <p>Control ID</p> <p>The control ID is used to specify which ID type, indicated by a number, will be used for the external controller. This is similar to the settings of a PTZ ID.</p> |
| ITEM 3 | <p>Baud Rate</p> <p>The baud rate setting is used to determine the speed setting between the DVR and external controller using the RS-485 KBD port. The KBD port uses two voltage states commonly known as MARK (negative) and SPACE (positive).</p> |
| ITEM 4 | <p>Data Bits</p> <p>The data bit setting is used to determine the order of transmission for the least significant bit (LSB) to the most significant bit (MSB). The optional settings are from 5 to 8 bits.</p> |
| ITEM 5 | <p>Stop Bits</p> <p>The stop bit setting determines the last part of the data frame. These bits are always represented by a negative voltage and will determine when data transmission will cease. The options for the stop bits are 1, 1.5, and 2 bits.</p> |
| ITEM 6 | <p>Parity</p> <p>The parity bit is used as a simple method of error checking. This option specifies whether the parity of the transmission will be None, Odd, or Even bits. Suppose the parity is chosen to be odd. The transmitter will then set the parity bit in such a way as to make an odd number of 1's among the data bits and the parity bit.</p> |

| | |
|---------------|--|
| ITEM 7 | Cancel The cancel button will close the current window, and will disregard the settings configured to this menu. |
| ITEM 8 | Save The save button will apply the settings made to this menu. |
| ITEM 9 | Default The default button will restore the original factory settings to this menu. |

CHAPTER 15. DEVICE

5. Remote Controller

There are up to 6 IDs' for the remote controller settings. The ID values are:

- Remote Control 1 Remote Control 2 Remote Control 3**
- Remote Control 4 Remote Control 5 Remote Control 6**

Each remote controller can operate up to 6 physical DVRs'. You use the ID settings to delegate which remote controller type will be used for which DVR since there will be an option for six different remote controller models.

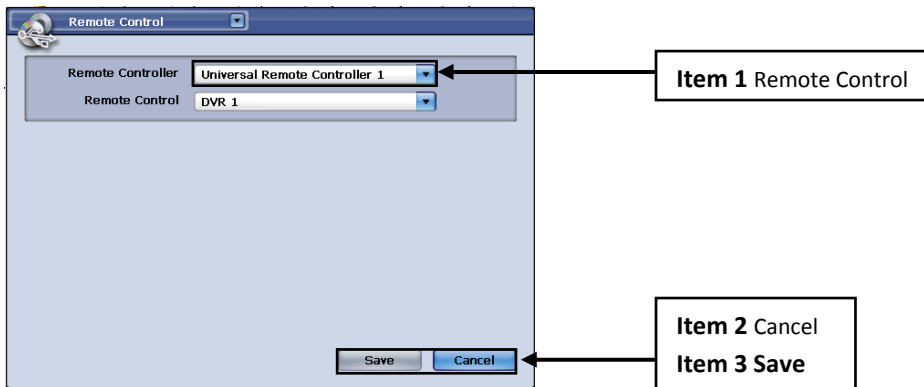

Figure 98

| | |
|---------------|--|
| ITEM 1 | Remote Control This option is used to specify which remote controller ID will be used. There are up to 6 different IDs' for the 6 different remote controller types. |
| ITEM 2 | Cancel This will close and cancel the settings made to this menu. |
| ITEM 3 | Save This will save the settings made to this menu. |

CHAPTER 16. NETWORK

1. Ethernet

The Ethernet menu is used to configure a remote connection to the DVR via your Local Area Network or the World Wide Web. There are various options in this menu for different networking environments.

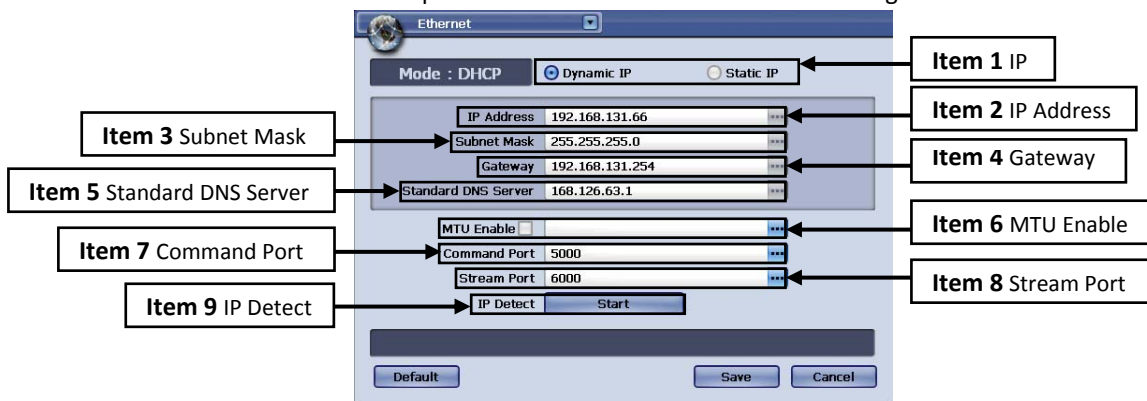



Figure 99

| | |
|----------------------|--|
| <p>ITEM 1</p> | <p>IP There are two options, “Static” or “Dynamic”. A “Static” IP is used when you desire to use the same IP address with the DVR. By choosing this option, you are able to choose the addressing information for the “Subnet Mask”, “Gateway”, and “Standard DNS Server”. A “Dynamic IP” address will be given to your DVR by your DHCP server. This is an automated process for IP address configuration. By choosing a “Dynamic IP” you will not be able to select the settings for “Subnet Mask”, “Gateway”, and “Standard DNS Server.”</p> |
| <p>ITEM 2</p> | <p>IP Address You can only specify the “IP Address” if you have chosen “Static IP”.</p> |
| <p>ITEM 3</p> | <p>Subnet Mask You can only specify the “Subnet Mask” if you have chosen “Static IP”.</p> |
| <p>ITEM 4</p> | <p>Gateway You can only specify the “Gateway” address if you have chosen “Static IP”.</p> |
| <p>ITEM 5</p> | <p>Standard DNS Server You can only specify the “Standard DNS Gateway” if you have chosen “Static IP”.</p> |
| <p>ITEM 6</p> | <p>MTU Enable This setting is recommended when using PPPoE or PPPoA (Minimum 100 Byte ~ Maximum 13312 Byte). To enable this setting, please check the box next to this option. Uncheck this option to disable this feature. If you have a standard Ethernet connection (Standard 8192 Byte), please uncheck this option.</p> |
| <p>ITEM 7</p> | <p>Command Port This setting is used to specify the remote configuration port when accessing the DVR from a remote location. (Caution: make sure that the Stream Port and the Command Port uses different port numbers)</p> |
| <p>ITEM 8</p> | <p>Stream Port This setting is used to specify the remote connection port for network video upload.</p> |
| <p>ITEM 9</p> | <p>IP Direct When you click the “Start” button, this will command the DVR to automatically obtain your network’s addressing information from your DHCP server. You will receive one of the following</p> |

two messages when requesting your network's addressing information:
Request Success - You will receive this message if the DVR successfully received the requested network information.
Request Failure – You will receive this message if the DVR unsuccessfully received the requested network information. The DVR will continually request your network's addressing information, or you may manually enter it by selecting "Static IP".
Static IP Address Error – If you receive this message, please confirm that the IP addressing information entered is correct.

Once your desired settings have been made, please click on the "Save" button to apply the changes. If you desire to discard the changes made to this menu, please click on the "Cancel" button.

You may navigate to any other desired menu by click on the  button located on the top left side of the screen.

CHAPTER 16. NETWORK
2. DDNS

The DDNS menu is used to configure your DVR to connect to our DDNS server.

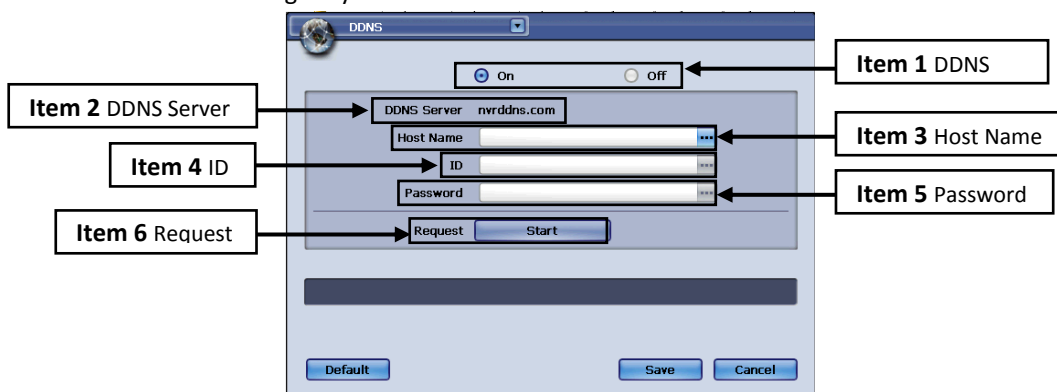



Figure 100

| | |
|---------------|---|
| ITEM 1 | DDNS You may choose the DDNS function "On" or "Off" by selecting either value. |
| ITEM 2 | DDNS Server NVRDDNS.com is the host name of our DDNS server. |
| ITEM 3 | Host Name The "Host Name" is your DVR ID. This ID must be unique. You can access your DVR via your web browser by entering, "Your Host Name (ID).nvrddns.com". Your host name will be used instead of your DVR's MAC address. |
| ITEM 4 | ID You must specify an "ID" for access to our DDNS server. |
| ITEM 5 | Password You must specify a "Password" for access to our DDNS server. |
| ITEM 6 | Request After entering your "Host Name", "ID", and "Password", press start to verify your information with our DDNS Server. You will receive one of the following messages after pressing "Start": Request - Request in process. DDNS Success – All information have been successfully registered with our DDNS Server. DDNS Data Error – There is missing information. DDNS Connection Failure – Unable to connect with our DDNS Server. DDNS Login Information Failed – There is duplicate login information. DDNS Host Already Exists – There is a duplicate Host name. DDNS Unknown Error – Please contact technical support. |

Once your desired settings have been made, please click on the "Save" button to apply the changes.

If you desire to discard the changes made to this menu, please click on the “Cancel” button. To restore the original factory settings, please click on the “Default” button. You may navigate to any other desired menu by click on the  button located on the top left side of the screen.

CHAPTER 16. NETWORK
3. Server Setup

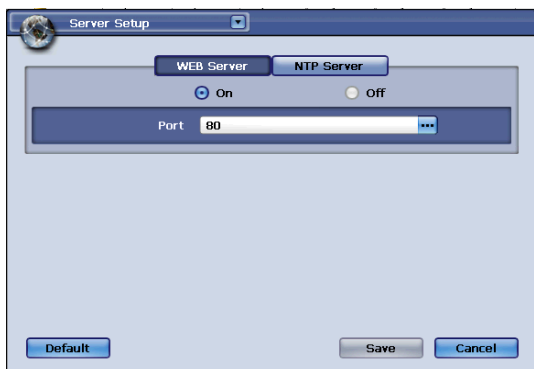

Figure 101

| | |
|---------------|--|
| ITEM 1 | <p>Web Server You can choose to turn the Web Server Function “On” or “Off”.</p> |
| ITEM 2 | <p>Port You may specify the port number for the web server, or you may leave the default port setting of “80”.</p> |

Please click the “NTP Server” tab to access the menu.

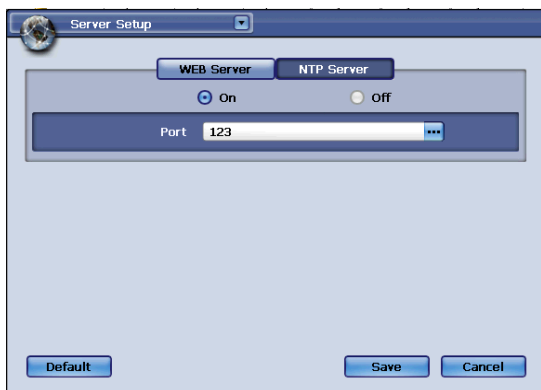



Figure 102

| | |
|---------------|---|
| ITEM 1 | <p>NTP Server You can choose to turn the NTP Server Function “On” or “Off”.</p> |
| ITEM 2 | <p>Port You may specify the port number for the NTP Server, or you may leave the default port setting of “123”.</p> |

Please click the “Web Server” tab to access the menu.

Once your desired settings have been made, please click on the “Save” button to apply the changes. If you desire to discard the changes made to this menu, please click on the “Cancel” button. To restore the original factory settings, please click on the “Default” button.

You may navigate to any other desired menu by click on the  button located on the top left side of the screen.

CHAPTER 16. NETWORK

4. PPPoE

The Ppoe menu is used to specify the ID and password used with their ADSL Internet Service.

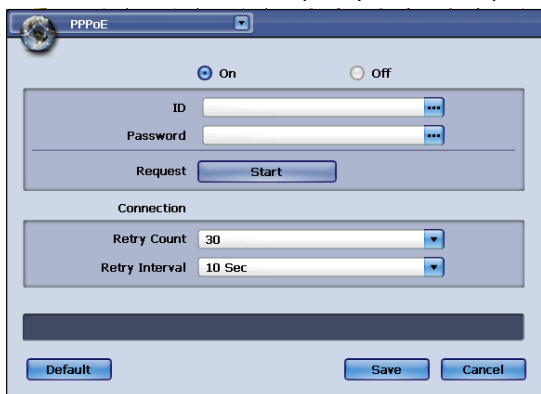



Figure 103

| | |
|---------------|---|
| ITEM 1 | <p>PPPoE You can choose to turn the Ppoe function “On” or “Off”.</p> |
| ITEM 2 | <p>ID Please enter the ID associated with your ADSL service.</p> |
| ITEM 3 | <p>Password Please enter the Password associated with your ADSL service.</p> |
| ITEM 4 | <p>Request Press the “Start” button to establish a connection with your Internet Service Provider.</p> |
| ITEM 5 | <p>Retry Count Use this option to specify the number of times the DVR will retry to connect with your Internet Service Provider (1~100 Times).</p> |
| ITEM 6 | <p>Retry Interval Use this option to specify how often, in seconds (1~60), your DVR will try to connect with your Internet Service Provider. You will see one of the following messages when trying to connect to your Internet Service Provider: Request – Connection request in progress. PPPoE Retry Count – The number of attempts to connect to your Internet Service Provider. PPPoE Connected – Connection is established. PPPoE Disconnect – Connection is terminated.</p> |

Once your desired settings have been made, please click on the “Save” button to apply the changes.

If you desire to discard the changes made to this menu, please click on the “Cancel” button.

To restore the original factory settings, please click on the “Default” button.

You may navigate to any other desired menu by click on the  button located on the top left side of the screen.

CHAPTER 16. NETWORK
5. Notification



Figure 104

Notification:

Please choose the events you would like the DVR to notify, e.g. Alarm, Motion Detection, Disk Full, Admin Password Changed, Video Loss, and Power On/Off.

Please click on the “Email” tab to access the menu.

Once your desired settings have been made, please click on the “Save” button to apply the changes.

If you desire to discard the changes made to this menu, please click on the “Cancel” button.

To restore the original factory settings, please click on the “Default” button.

You may navigate to any other desired menu by click on the  button located on the top left side of the screen.

Email

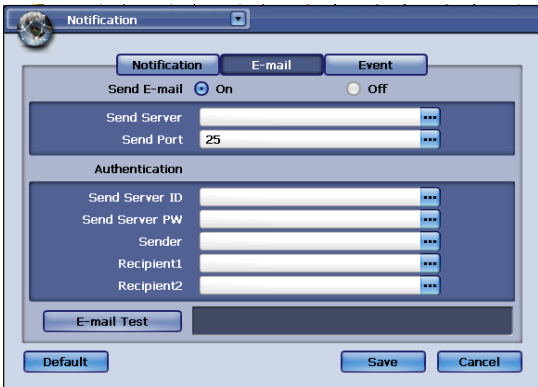

Figure 105

| | |
|---------------|--|
| ITEM 1 | Send Email You can choose to turn the Send Email function “On” or “Off”. |
| ITEM 2 | Send Server Please enter your SMTP server address here. |
| ITEM 3 | Send Port Please enter your SMTP server port here. |
| ITEM 4 | Send Server ID Please enter the user ID associated with your SMTP server account. |
| ITEM 5 | Send Server PW Please enter the password associated with your SMTP server account. |
| ITEM 6 | Sender Please enter the sender’s emails address here. |

| | |
|---------------|--|
| ITEM 7 | Recipient1 Please enter the recipients email address here. |
| ITEM 8 | Recipient2 Please enter a second recipients email address here (optional). |

Please click on the "Notification" or "Event" tab to access the menu.

You will receive one of the following two messages when clicking on the "Email Test" button:

Request Success – The email notification test was successful.

Request Failure – The email notification test failed.

Once your desired settings have been made, please click on the "Save" button to apply the changes.

If you desire to discard the changes made to this menu, please click on the "Cancel" button.

To restore the original factory settings, please click on the "Default" button.

You may navigate to any other desired menu by click on the  button located on the top left side of the screen.

Event

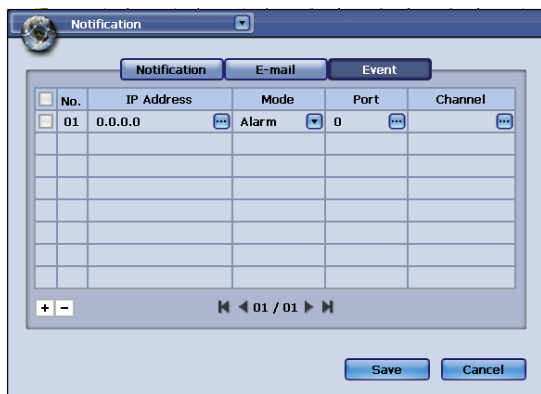





Figure 106

The "Event" tab is used to specify a server to send event notifications to.

| | |
|---------------|--|
| ITEM 1 | IP Address Please specify an IP address of the PC that has the installed Event Server Program. |
| ITEM 2 | Mode Please specify the type of event to send, e.g. Alarm, Motion, Video Loss, or All. |
| ITEM 3 | Port Please specify the port number for the PC that has the installed Event Server Program. |
| ITEM 4 | +/- Please use the + button to add a schedule item. To remove a scheduled item, check the corresponding box and click on -. -  : Press this button to go to the first page  : Press this button to go to the previous page -  : Press this button to go to the next page  : Press this button to go to the last page |

Please click on the "Notification" or "E-Mail" tab to access the menu.

Once your desired settings have been made, please click on the "Save" button to apply the changes.

If you desire to discard the changes made to this menu, please click on the "Cancel" button.

To restore the original factory settings, please click on the "Default" button.

You may navigate to any other desired menu by click on the  button located on the top left side of the screen.

H.264 Digital Video Recorder

8 and 16 Channel D1 recording at 30fps every individual channel



Future of Digital Video Recording at Hand