

4Ch Real time / Triplex / Mux

Stand Alone DVR

User's Manual **VER 1.3**



4 Channel Stand Alone DVR
USB Backup available

The most stable and reliable real stand alone Digital Video Multiplex Recorder

INSTALLATION & SAFEGUARDS

All the safety and operating instructions should be read before the unit is operated.

Environment Condition for Installation

1. To prevent electric shock or other hazard, do not expose units to rain, moisture, or dust.
2. Place this unit in a well-ventilated place and do not place heat-generating objects on this unit.
3. This unit should not be located in an area where it is likely to be subjected to mechanical shocks.



Before You Start

1. Ensure the power switch is in the OFF position prior to starting.
2. Do not attempt to open or remove the covers. That may expose you to dangerous voltage or other hazards.
3. Installation should be performed by qualified service personnel only.
4. This unit should be operated only from the type of power source indicated on the manufacturer's label and with the power supply included with the unit.



Notice

1. Before initial configuration or operation you must first set the TIME/DATE, followed by HDD clear. If you don't follow this steps first, that may cause non recording on the HDD or non saving setting value. Even though it is recorded, you cannot search recorded data.
2. When it comes to HDD capacity, you can use a big size of HDD.
3. A jumper setting for CD-RW must be master.
4. When you set the record setup, you have to set the Record Configuration and also Schedule Setup. This unit records as per the Record type & Schedule setup. The default setting value for Schedule setup is Continuous mode.

Contents

CHAP. 1	Features & Package Contents	-----	4
1-1.	Features	-----	4
1-2.	Package Contents	-----	5
CHAP. 2	Function of Each Button	-----	6
2-1.	Front	-----	6
2-2.	Rear	-----	7
CHAP. 3	Installation	-----	8
3-1.	Installation Configuration	-----	8
3-2.	Detailed Installation	-----	9
1)	HDD(Hard Disk Drive)	-----	9
2)	Camera	-----	9
3)	Monitor	-----	10
4)	Power	-----	10
5)	Other External Device	-----	11
6)	RS-232 ASCII-Code	-----	11
CHAP. 4	Operation	-----	12
4-1.	System Log In	-----	12
4-2.	Factory Default	-----	12
4-3.	Display Configuration	-----	13
4-4.	Live View Setup	-----	14
1)	Full / Multiple View	-----	14
2)	SEQ	-----	14
3)	PIP View	-----	14
4)	ZOOM View	-----	14
4-5.	Record	-----	15
4-6.	Playback	-----	15
4-7.	Search	-----	16
4-8.	PTZ Camera Operation	-----	17
4-9.	Data Back-up	-----	17

CHAP. 5	Set up	-----	18
5-1.	General Operation	-----	18
5-2.	Display Setup	-----	19
1)	VGA Setup	-----	19
2)	Screen Display Setup	-----	19
2)	OSD Setup	-----	20
5-3.	Record	-----	21
1)	Record Setup	-----	21
2)	Schedule Setup	-----	22
5-3.	Configuration	-----	23
1)	HDD Management	-----	23
2)	Time/Date Setup	-----	24
3)	Camera Setup	-----	24
4)	Motion Setup	-----	25
5)	Interval Setup	-----	26
6)	Alarm Setup	-----	26
7)	Password Setup	-----	26
5-4.	External Device Setup	-----	27
1)	TCP/IP Setup	-----	27
2)	Pan Tilt Zoom Setup	-----	28
3)	Spot Setup	-----	28
5-5.	Back up	-----	29
1)	CDR Setup	-----	29
2)	USB Setup	-----	29
5-6.	Firmware Upgrade	-----	30
CHAP. 6	Network Setup	-----	31
6-1.	DVR Network Configuration	-----	31
6-2.	Remote Viewer Program	-----	35
6-3.	Backup CD Player	-----	40
CHAP. 7	Web Viewer Setup	-----	42
7-1.	Registering DVR for DDNS	-----	42
7-2.	DDNS Setup in DVR	-----	44
7-3.	Web Viewer	-----	48
7-4.	Web Backup Player	-----	49
7-5.	Web Backup	-----	51
CHAP. 8	Specifications	-----	54

CHAP 1. Features & Package Contents

1-1. Features

Live Display

Real time display per camera
Auto Sequence
PIP (Picture in picture)
Digital Zoom of display
Simple playback mode
Simple PTZ camera control

Record

Variable Record resolution (For higher picture quality or higher recording speed)
Efficient Image Quality step in 5 steps
Schedule recording
Event Record by alarm and motion detection

Network

Monitoring and Search by using Remote Viewer via network

Playback

Search and playback by recorded data size and date/time

Various steps in forward playback speed (X2, X4, X8, X16, X32 fast playback. 1/16, 1/8, 1/4, 1/2 slow playback)

Various steps in backward playback speed (X2, X4, X8, X16, X32 fast playback. 1/16, 1/8, 1/4, 1/2 slow playback)

Data backup

Simple backup using CD-RW
Remote viewer backup in AVI, JPEG file
Supports bigger capacity of HDD
USB Device Back-Up available

Others

Supports UNI-CODE
Supports SPOT Monitor
PAL/NTSC Auto detection

1-2. Package Contents

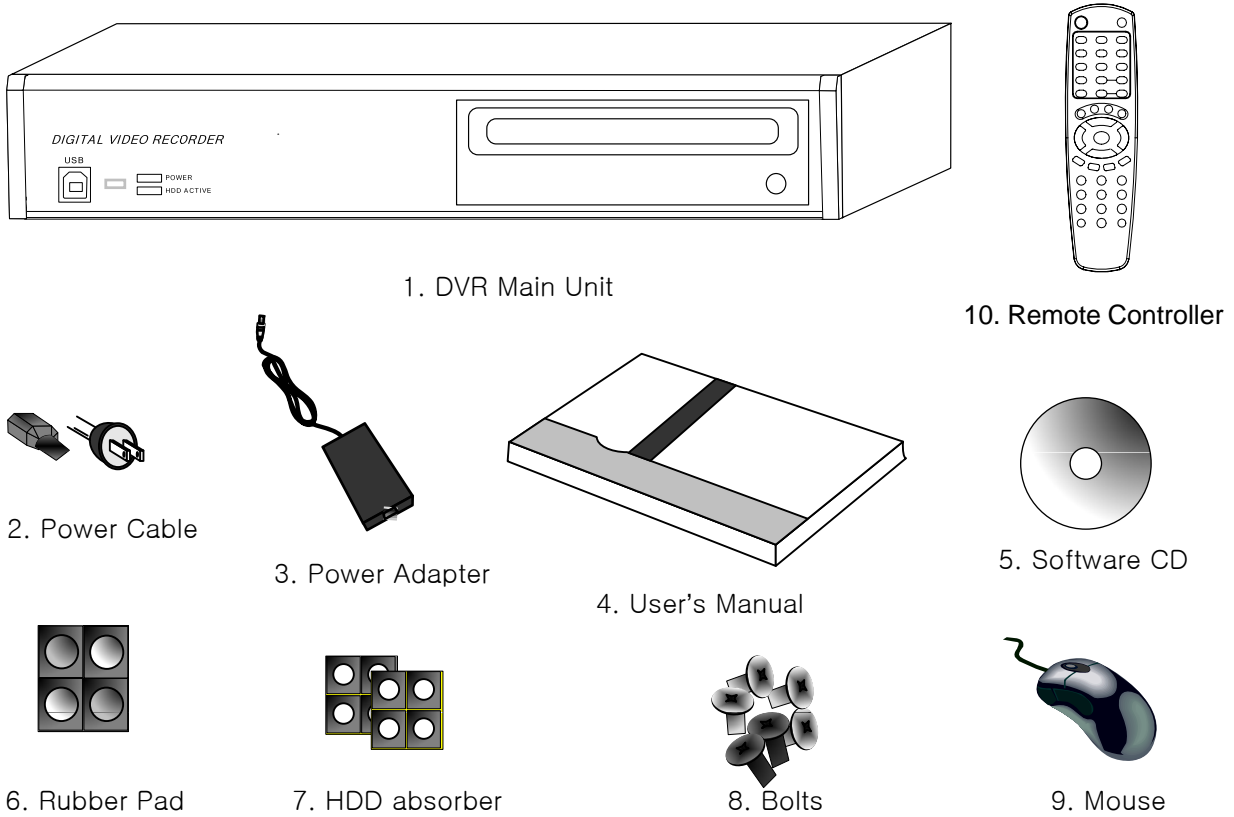

Package Contents	Description
1. DVR Main Unit	Stand-Alone Digital Video Recorder
2. Power Cable	AC power supply to adapters for 12V DC power
3. Power Adapter	DC power supply
4. User's Manual	User's Manual
5. Software CD	Remote Viewer Software & Backup CD Player
6. Rubber Pad	Prevent DVR from slipping. Attach it to the bottom of main unit
7. HDD absorber	Absorbing the mechanical shock of HDD against the case bottom
8. Bolts	Bolts for fixing HDD
9. Mouse	A mouse controlling all functions of DVR
10. Remote Controller	DVR control

CHAP 2. Function of Each Button

2-1. Front

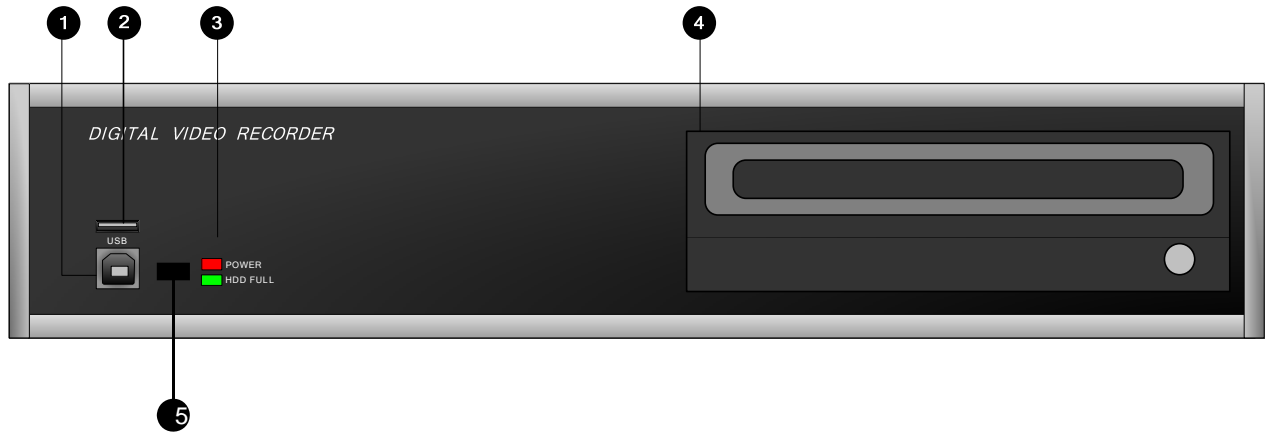

Name	Function
① USB Device	Used for updating Firmware
② USB HOST	Used for Data Backup
③ LED Lamps	Shows status of operation
④ CD – RW	Used for Data Backup and Firmware upgrade
⑤ IR	IR receiver

2-2. Rear

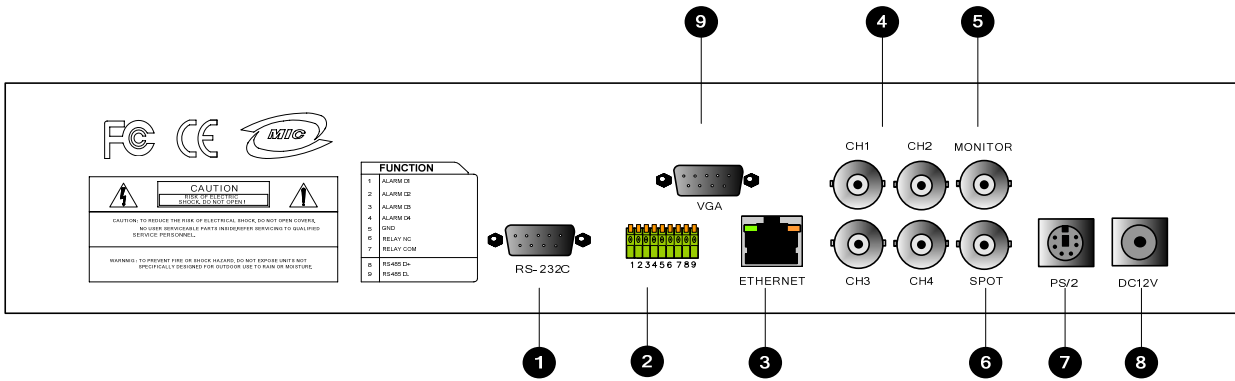

	Name	Function
1	RS-232C	Connection to external device as PC using RS-232C to control the DVR
2	RS 485	Connection with PTZ camera or other external device using RS 485 interface
	RELAY Output	Relay out terminal
	SENSOR Input	Sensor input terminal
3	ETHERNET	Connection to ETHERNET device
4	CAMERA Input	Connection with camera (NTSC / PAL)
5	MONITOR Output	Connection with Composite Monitor (NTSC / PAL)
6	SPOT Monitor Output	Connection with Composite Monitor (NTSC / PAL)
7	PS/2	Connection with PS/2 MOUSE
8	DC Power	DC over 12V adapter
9	VGA	Connection to VGA Monitor (CRT type or TFT LCD monitor)

CHAP.3 Installation

3-1. Installation Configuration

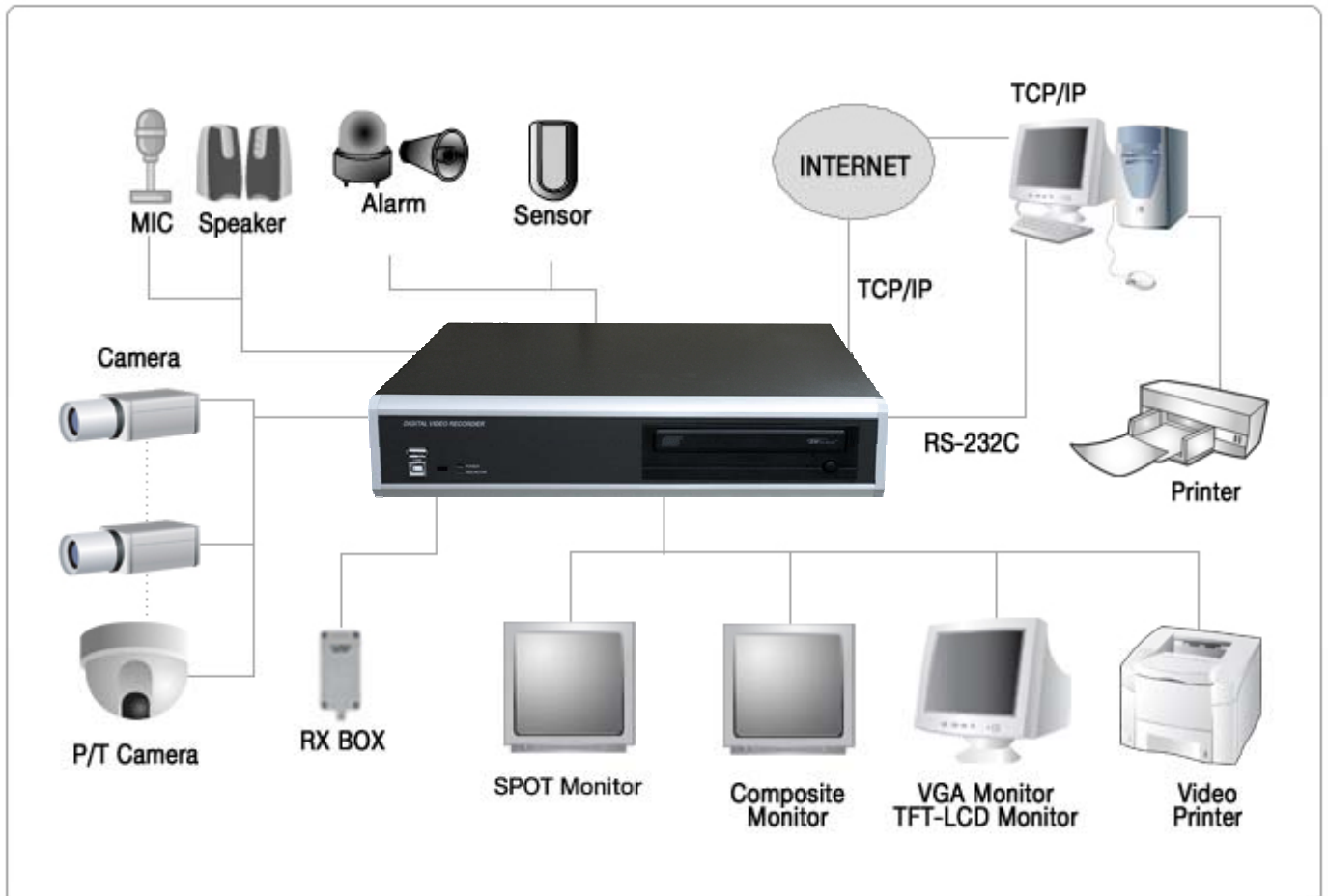

3-2. Detailed Installation

1) HDD

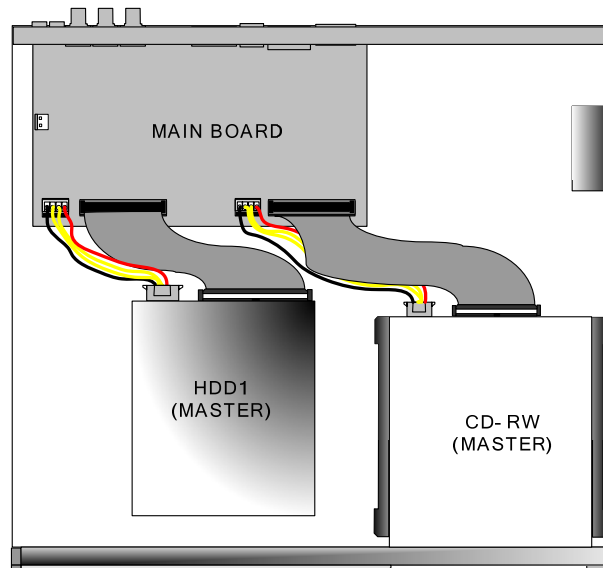

1. Connect Main Board and HDD1 using IDE cable and HDD power cable.
2. The jumper setting of HDD should be on Master when you install HDD.
3. Stick the HDD absorber (included in package) on the bottom of case and then install the HDD on top of them by using the bolts (included in package).
4. Screws must be inserted from outside of the case bottom.

2) Camera

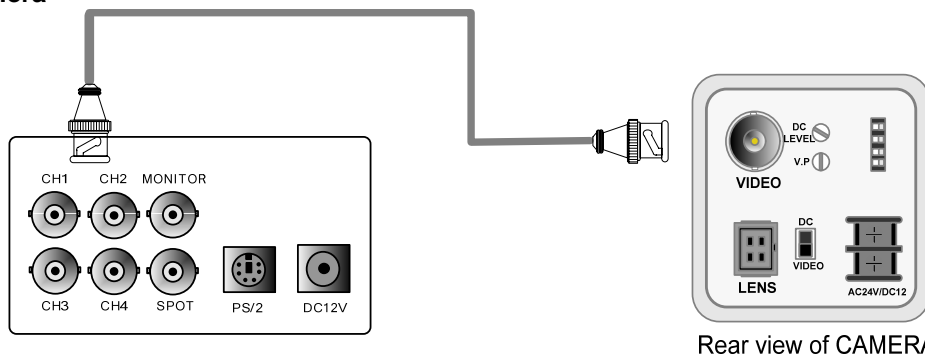

Rear view of CAMERA

Connect camera to the camera input on rear panel of DVR marked CAMERA IN.

3) Monitor

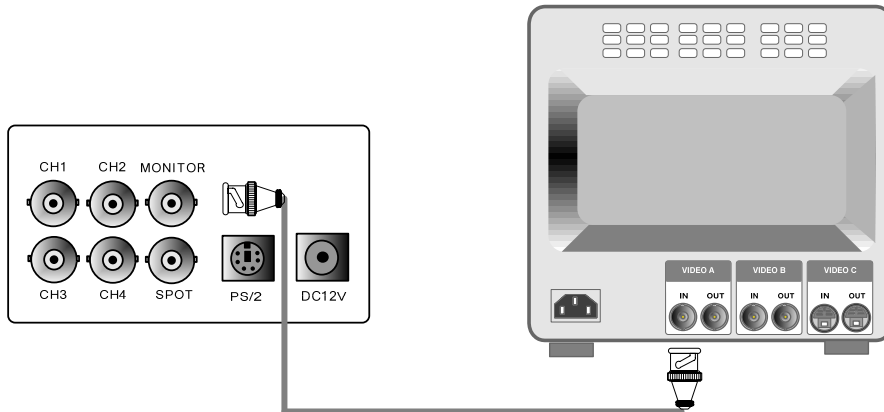

Connect the video output marked MONITOR to Video-In of Main monitor.

4) Power

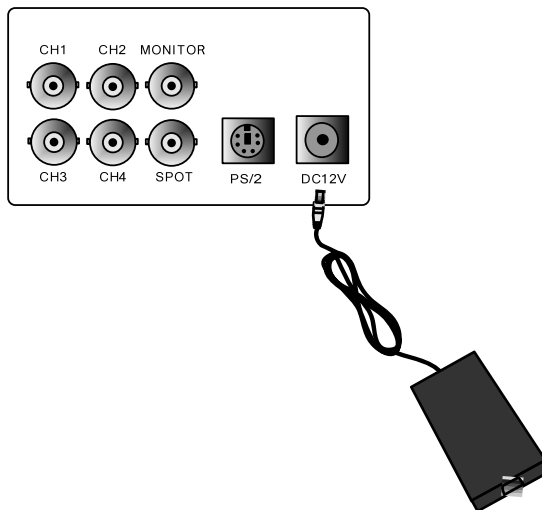

DC over 12V adapter

5) Other External Device

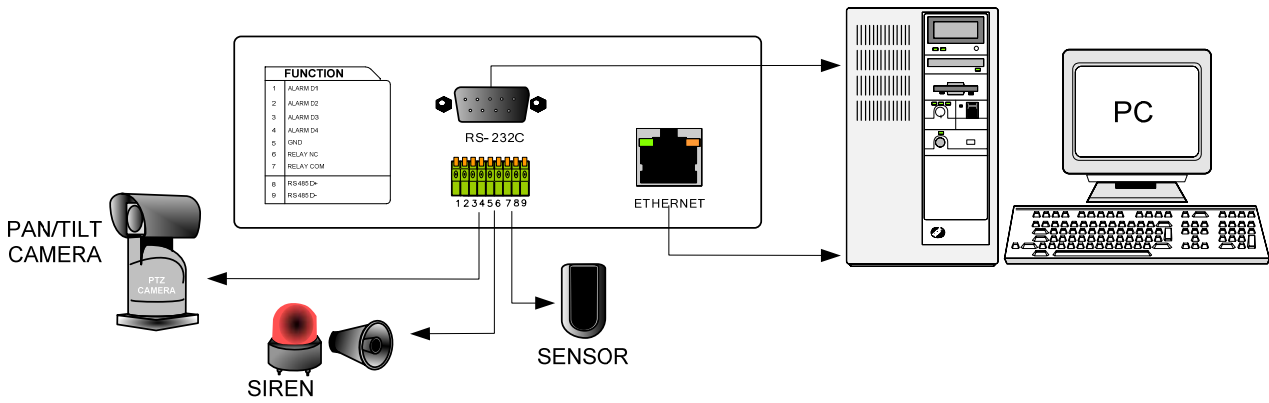

RS-485 : Control external device like PTZ camera.
(Pin No.8 & No.9 at D-SUB).

RELAY Output : Relay Output (Pin No.6 & No.7).

SENSOR Input : Sensor Input – Alarm Input (Pin No.1 ~ No.4).

ETHERNET : Connection to LAN, WAN t.

6) RS-232C ASCII-code

Following ASCII-Codes (Hexa-Code) are for programmers who want to control DVR unit via the RS232C Port using keyboard of PC. ASCII-Code is 1 Byte.

녹화	'R'	DOWN	'J'	PTZ	'T'	CH1	'1'
STOP	'S'	LEFT	'H'	ZOOM	'Z'	CH2	'2'
재생	'P'	RIGHT	'K'	FRZ	'F'	CH3	'3'
Pause	'A'	NEXT	'N'	MODE	'D'	CH4	'4'
SERCH	'E'	ENTER	0x0d	PIP	'I'		
MENU	'M'	-	'<'	SEQ	'Q'		
UP	'U'	+	'>'				

4-1. System Log-In

- 1) Move a cursor to lower right hand corner of display by using a mouse, then you will see 'Menu' Icon. Click the 'Menu' Icon to log in.
- 2) Then, you will see 'DVR Log-In' message shown as right.
- 3) You may log in as a ADMIN, MANAGER, or USER1 ~ USER8.
- 4) Input your password (Max. 8 digits are available for password)
- 5) To exit, click 'EXIT' button.

The screenshot shows a login interface with the following elements:

- Header: **DVR LOG-IN**
- Fields: **USER ID** (containing 'ADMIN') and **USER PW** (empty).
- Input: A row of numeric buttons from 0 to 9.
- Actions: **ENTER** and **EXIT** buttons.

If the password entered matches previously set password, you can log into 'MAIN MENU'. If an incorrect password is entered, you will see "PW IS NOT CORRECT" message on display. The factory default password is none. Just click [ENTER] for first time initial log in.

-Factory default password
ADMIN : (Blank)

※ For security reasons, be sure to make note of your own password.

4-2. Factory Default

Before first operation, you must check out each channel is displaying properly and log in 'Main Menu' and set Time/Date and set HDD clear.

1. HDD Management

HDD MANAGEMENT CAMERA SETUP MOTION SETUP ALARM SETUP INTERVAL SETUP TIME/DATE SETUP PASSWORD SETUP	MODEL SERIAL BLOCKS SIZE SPEED ----- OVERWRITE CLEAR ESC
---	--

4-3. Display Configuration

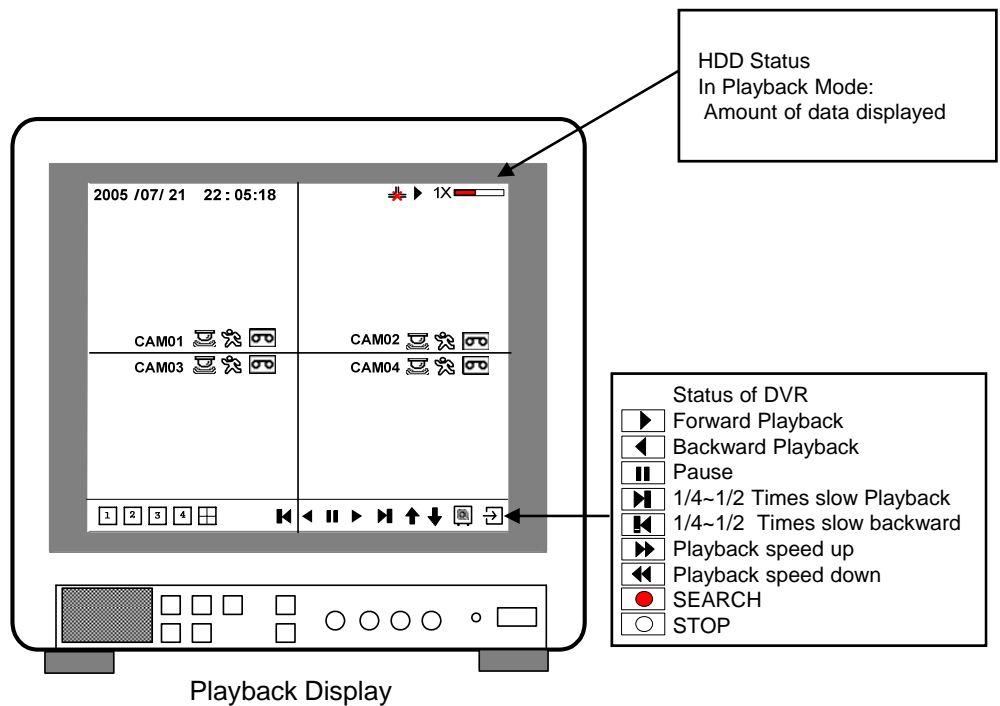
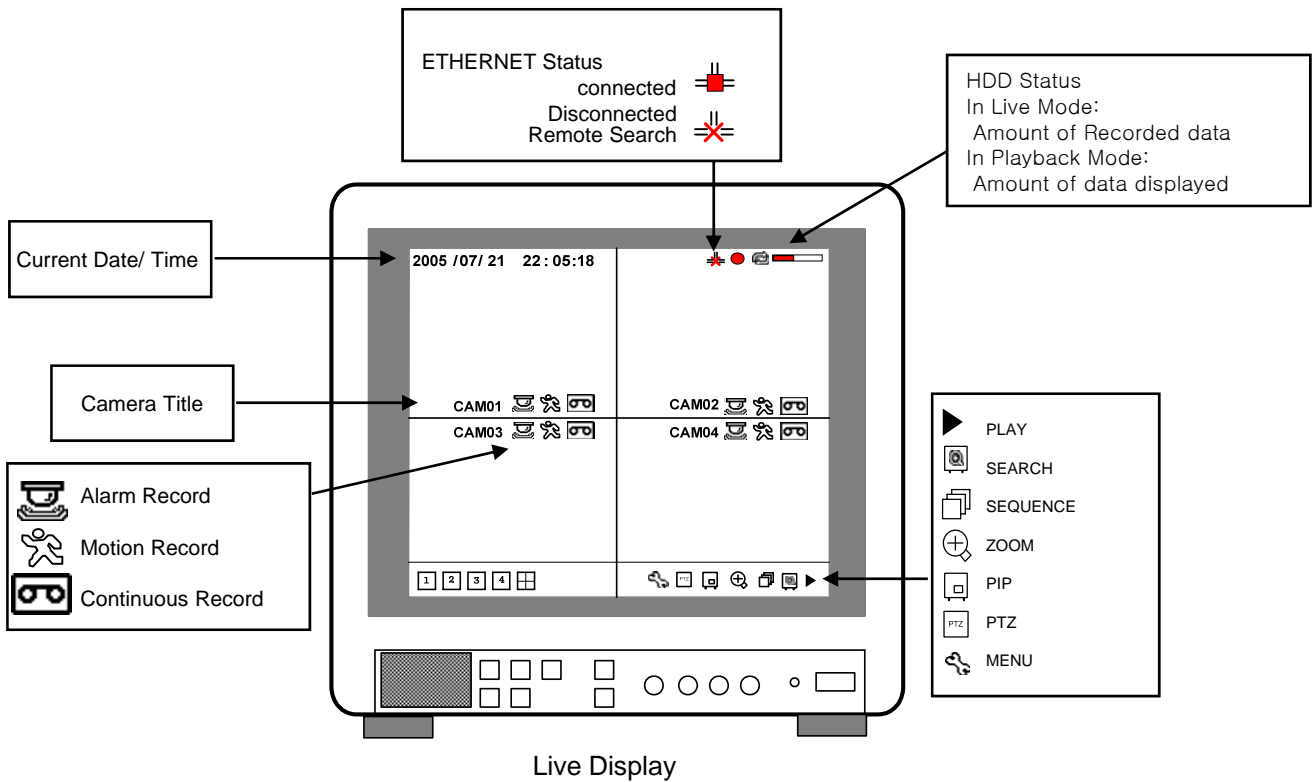

4-4. Live View Setup

1) Full / Multiple View

Move a cursor to 'split icon' on the lower left corner of display and click it to view 4 channel division. To enlarge each channel, click 1,2,3,4 Icon. Then, you will see a channel in full screen mode.

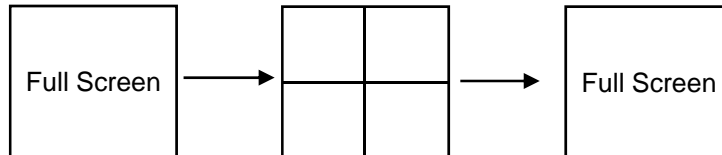

2) SEQ

Click 'SEQ' icon. It automatically displays full screen images in sequence. You can setup SEQ time interval on setup menu. (SCREEN SETUP – SEQUENCE INTERVAL)

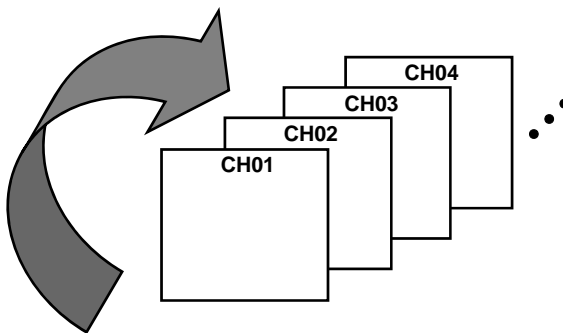

3) Picture in Picture (PIP View)

When it is in full screen display mode, you can see other camera in a small window by clicking [PIP] icon. The other camera in small window is rotating in sequence to next number of camera and you can set the rotating time interval as per the procedure in Main Menu – SCREEN SETUP – PIP INTERVAL.

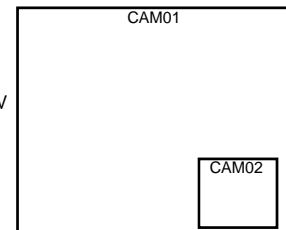

4) ZOOM View

In live mode, if you click [ZOOM] icon, images are displayed in two times larger size. While using [ZOOM] mode, you can move the enlargement area by using a mouse. To exit ZOOM mode, click ZOOM] icon again.

4-5. Record

It records as a setting made by a user in Schedule Mode.

- Schedule Record
Go to MAIN MENU-SCHEDULE SETUP and setup schedule as you want. It records as a setting.
- Record Icon in Red indicates Schedule Record, Motion record, and alarm record.

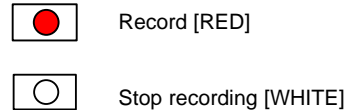
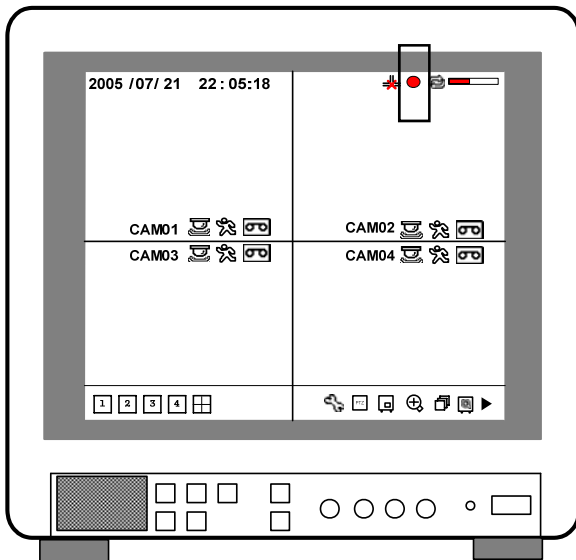

- This DVR unit does not record in following conditions ;
 - ※ When Over write function is off and HDD is full
 - ※ When you back up recorded images by using CDRW burning.
 - ※ When you update a firmware
 - ※ When you are in HDD management menu mode

4-6. Playback

1. On record mode or stop mode, click [click] to play the recorded data in 1x speed.
2. How to use a mouse
Left button on a mouse is used for all command in menu.
You can adjust playback speed by moving a mouse wheel button up and down.

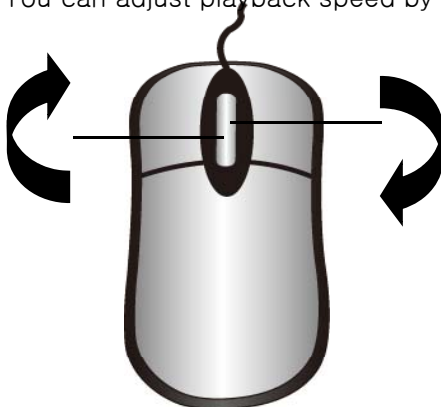

- 1/16x: 16 times slower than normal playback speed.
- 1/8x : 8 times slower than normal playback speed.
- 1/4x : 4 times slower than normal playback speed.
- 1/2x : 2 times slower than normal playback speed.
- 1x : Normal playback speed
- 2x : 2 times faster than normal playback speed..
- 4x : 4 times faster than normal playback speed.
- 8x : 8 times faster than normal playback speed.
- 16x : 16 times faster than normal playback speed.
- 32x : 32 times faster than normal playback speed.

4-7. SEARCH

There are three search methods controlled by a mouse wheel button, left and right button of a mouse.

When you click [SEARCH] icon, then you see a window shown as below.

Select a target data by using a mouse.

In PERCENT SEARCH Mode, you can select a certain data by clicking on the bar.

To move to the previous mode, click 'ESC'.

1. PERCENT SEARCH

Search by percentage of total recorded data. It starts from image corresponding to set % of data on the search bar.

2. TIME/DATE SEARCH

Search by time & date. Playback starts from the time & date selected.

3. EVENT SEARCH

Search by event list (Motion, Alarm, Video Loss)

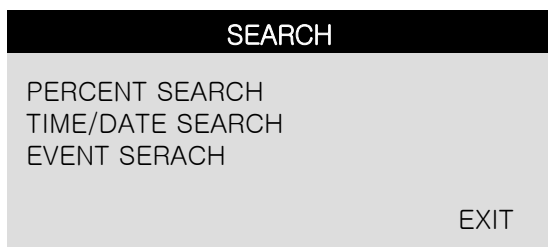

SEARCH MAIN MENU

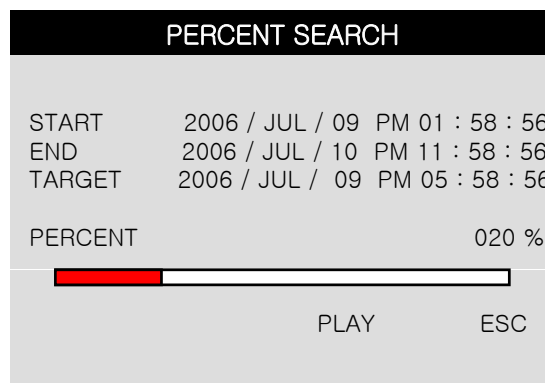

PERCENT SEARCH



TIME/DATE SEARCH

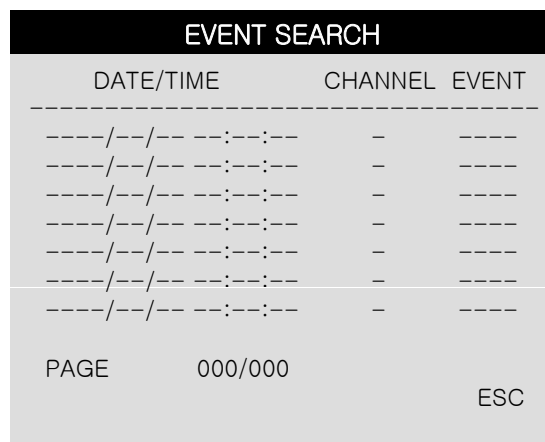

EVENT SEARCH

4-8. PAN/TILT/ZOOM Camera Operation

Click [PTZ] icon to control a PTZ camera. PAN/TILT is controlled by Left & Right buttons and Zoom In & Out is controlled by a wheel of a mouse. You can control a PTZ camera in 8 different directions as shown below.

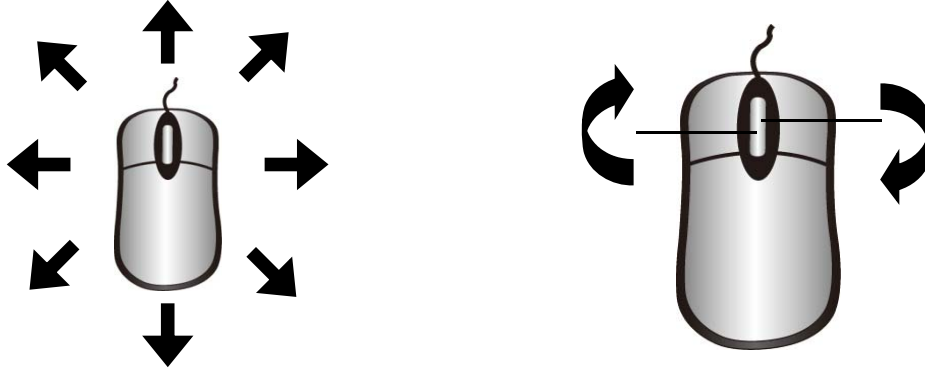

4-9. Data Backup

Click [MENU] icon first.

1. Insert empty CD-R media into CD writer and select the start time & date from which you want to back up.
 - ※ The START & END time / date in HDD sub-menu only shows start and end of recording. This is not selectable and editable.
2. To set start time of back-up and back-up data size of CD-R media inserted, use a mouse.
 - ※ End of back-up time will be calculated automatically as per start time & date and the back-up data size you set.
 - ※ You can select the back-up data size (size of back-up data from start of back-up), but END of back-up time is automatically determined by DVR itself.
3. Click 'BURN' then it starts burning a CD.
4. When burning is completed, CD-R media will come out automatically. In the next CD back-up, start time of CD-R shall be the end of previous CD-back-up, and you can back-up from that for continuous data back-up. If you need another back-up, repeat the above procedure. To stop backup, click 'ESC'.
 - ※ While you are burning a CD, it is impossible to cancel burning process.
 - ※ During burning process, DVR does not record.
5. You can verify the back-up CD and install the Backup CD Player on your PC to view the backup data.

BACK-UP	
HDD	
START	2006/JUL/08 AM10:10:23
END	2006/JUL/09 AM08:12:23
CD-R	
START	2006/JUL/08 PM12:04:12
END	2006/JUL/08 PM08:12:23
SIZE	700MB -> 0MB
BURN ESC	

BACK-UP	
HDD	
START	2006/JUL/08 PM 12:04:12
END	2006/JUL/08 PM 08:12:23
CD-R	
START	2005/AUG/07 AM04:04:12
END	2005/AUG/08 PM08:12:23
SIZE	700 MB - > 700MB
	
BURN ESC	

CHAP. 5 Set up

5-1. General Operation

Click [MENU] icon and input user password to log in.

Mouse buttons	Functions
Mouse Wheel	Up and down of setup value on the Menu mode Up and down of Playback speed Zoom in and out in PAN/TILT/ZOOM mode
Right	Decrease of setup value on the Menu mode
Left	Increase of setup value on the Menu mode Execute all of the function (clicking icons)

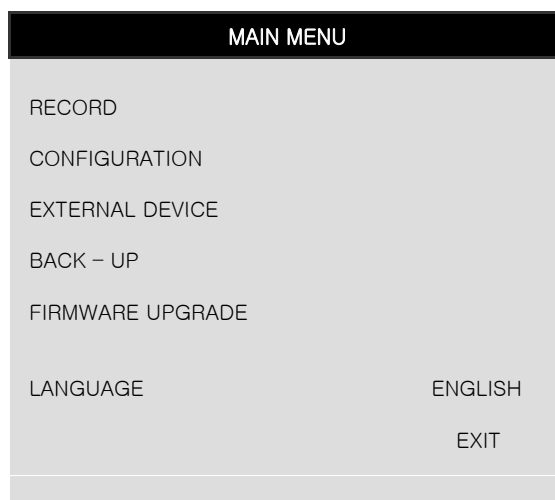

MAIN MENU

5-2. DISPLAY SETUP

This is setup menu for display on the screen.

If you click 'DISPLAY SET UP', then you change setting values for display as shown below.

DISPLAY SETUP	
VGA SETUP	
SCREEN DISPLAY	
OSD SETUP	
	ESC

1) VGA SETUP

VGA SETUP	
RESOLUTION	800 X 600 / 75Hz
	DEFAULT ESC

VGA SETUP : Connection to a VGA monitor (CRT/TFT LCD), if optional VGA board is fixed on the main board.

You can set 'RESOLUTION' for VGA as shown below.

(VGA Default is 800X600.)

*If there is no VGA option board fixed on the main board or not detected correctly, it displays "No VGA BOARD"

640X480 / 60Hz	640X480 / 75Hz
800X600 / 60Hz	800X600 / 75Hz
1024X768 / 60Hz	1024X768 / 75Hz
1280X1224 / 60Hz	1280X1024 / 75Hz

**** Please check the resolution range that your VGA monitor supports first before you use VGA monitor. If you select high resolution such as 1024X768, 1280X1224 on VGA SETUP with VGA monitor that does NOT support those high resolutions, image display may NOT be seen properly.**

2) SCREEN DISPLAY

SCREEN DISPLAY	
VERTICAL POSITION	24
HORIZONTAL POSITION	00
BOARDER ENABLE	ON
BOARDER WIDTH	01
BOARDER COLOR	GRAY
	DEFAULT ESC

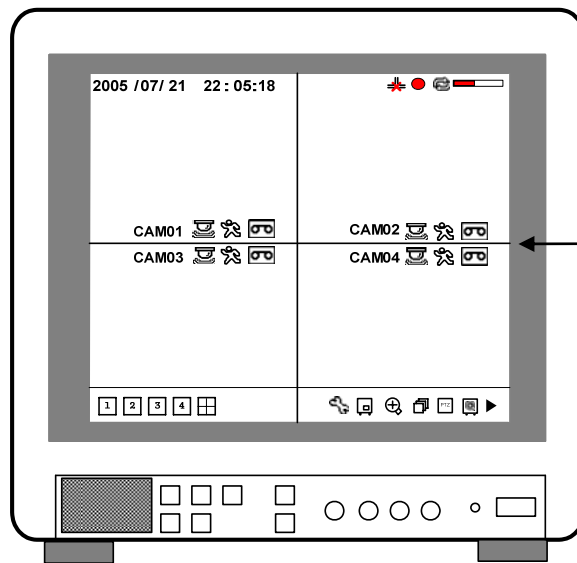

VERTICAL POSITION : 0 ~ 63
 HORIZONTAL POSITION : 0 ~ 63
 BORDER ENABLE : ON/OFF
 BORDER WIDTH : 1 ~ 10
 BORDER COLOR : COLOR SELECT

3) OSD SETUP

OSD SETUP	
TOP OSD OFFSET	0
BOTTOM OSD OFFSET	0
DEFAULT	ESC

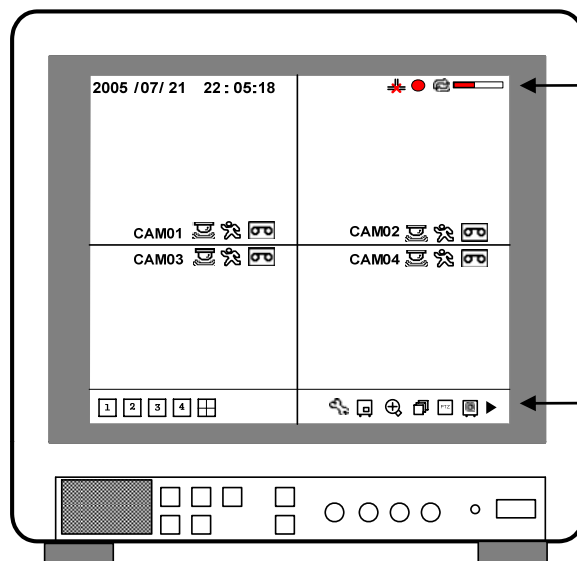

TOP OSD OFFSET : -10 ~ 9

BOTTOM OSD OFFSET : -10 ~ 9

5-3. RECORD

This is the most important configuration of the DVR. When you select 'RECORD SETUP' in the main menu, you can see the window as shown on the left.

1) RECORD SETUP

You can change setup value by using a mouse.

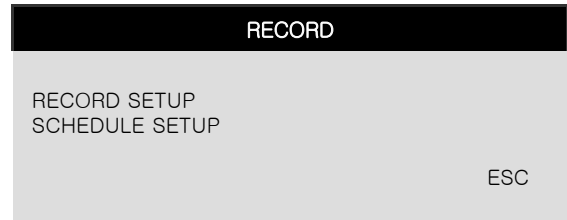

(1) CHANNEL : CHANNEL select

(2) QUALITY : Set recording picture quality.
(There are five quality steps)

- LOWEST
- LOW
- NORMAL [DEFAULT]
- HIGH
- HIGHEST

To send more images via IP network and longer recording time, set Quality at 'LOW' or 'NORMAL' and record at 360x240.

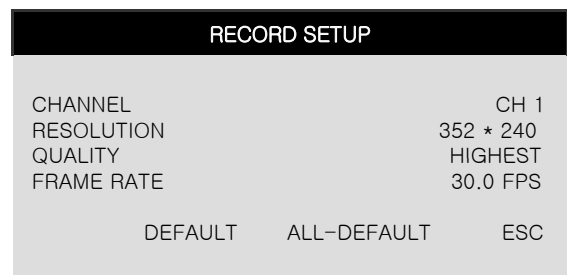

Data size of image in PAL system is a little bigger than NTSC system, but the total recording time is same as in NTSC system.

(3) RESOLUTION : Set recording resolution

- 704x240(NTSC) , 720x288(PAL)
- 352x240(NTSC) , 360x288(PAL) [DEFAULT]

(4) FRAME RATE : Set FRAME

- 1 ~ 30 FPS(NTSC) [DEFAULT 7.5 FPS]
- 1 ~ 25 FPS(PAL) [DEFAULT 7.5 FPS]

2) SCHEDULE SETUP

Unless you selected other recording mode, DVR system records in Schedule Recording mode. In Schedule Recording mode, you set type of recording by 1 hour time interval. Default frame rate for continuous recording speed is 30 FPS.

Set Recording time interval for a day of the week and recording type (1 hour time interval)

The screenshot shows the 'SCHEDULE SETUP' menu. At the top, it says 'CHANNEL TYPE' and 'CH 1 CONTINUE'. Below this is a grid with days of the week (SUN, MON, TUE, WED, THU, FRI, SAT) on the vertical axis and hours (0-23) on the horizontal axis. Below the grid are four buttons: 'C' (with a red box), 'M' (with a blue box), 'A' (with a green box), and 'M&A' (with a yellow box). Below these buttons are labels: 'DEFAULT', 'ALL - DEFAULT', and 'ESC'. At the bottom, there are labels for 'DATE', 'RED', 'BLUE', 'GREEN', and 'YELLOW'. An arrow points from the 'ALL' button to the text: 'Click 'ALL' to set the same setting value 24 hours a day and 7 days a week.' Another arrow points from the grid to the text: '1 hour interval'.

- TYPE : Set up Recording type
- CONTINUE: 24 hour recording
- ALARM: Alarm recording
- MOTION : motion recording
- MOTION & ALARM : Motion & Alarm recording

※ Each type is indicated in different color of boxes.
 You can set up schedule by dragging a mouse and all blocks can be activated or deactivated by using 'ALL' button.

※ Default setting is continuous recording.

5-4. CONFIGURATION

When you click 'CONFIGURATION' on the main menu, you can go to 'CONFIGURATION' menu as shown on the right.

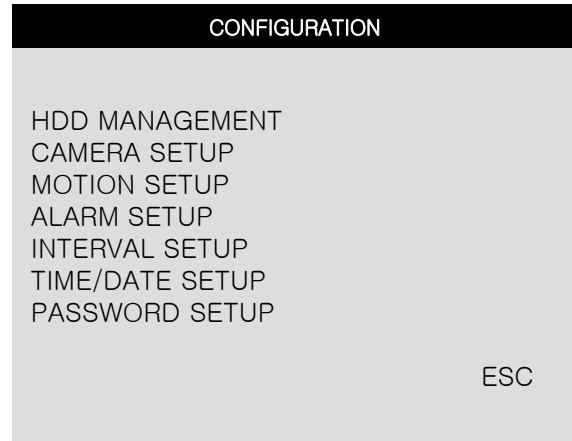

1) HDD MANAGEMENT

You can see HDD Model name, serial number, number of blocks and size of HDD. You can also clear HDD. (While you are in this HDD MANAGEMENT Mode, DVR does NOT record.)

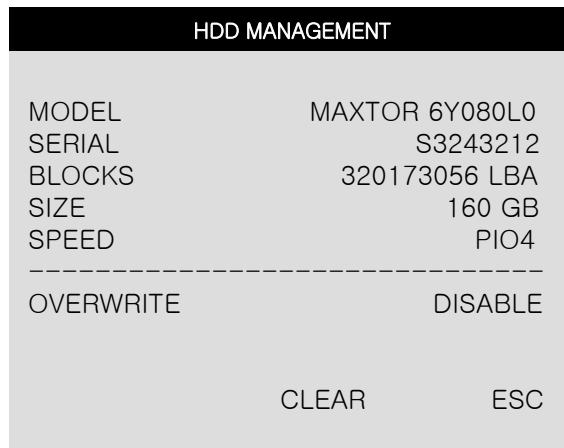

MODEL : HDD MODEL NAME
 SERIAL : HDD SERIAL No.
 BLOCKS : HDD LBA BLOCK Number
 SIZE : HDD TOTAL SIZE
 SPEED : HDD MODE
 OVERWRITE : ENABLE, DISABLE

2) TIME/DATE SETUP

In this setup, you can select date/time of DVR system and display format.

You can adjust values by using a mouse wheel or left/right button of a mouse.

※ For the first time installation, date/time setup must be completed first.

DATE FORMAT : DATE(ASIAN/EUROPEAN
/AMERICAN)

HOUR FORMAT : (2H/24H)

MONTH FORMAT : (ENGLISH,NUMERIC)

TIME/DATE SETUP	
DATE	2006/JUL/08
TIME	15:41 :45
DATE FORMAT	ASIAN
HOUR FORMAT	24HOUR
MONTH FORMAT	ENGLISH
DEFAULT	ESC

3) CAMERA SETUP

You can setup values for each camera.

CAMERA SETUP		
CHANNEL	CH1	
TITLE	CAM01__	
BRIGHTNESS	0	
CONTRAST	0	
SATURATION	0	
HUE	0	
DEFAULT	ALL-DEFAULT	ESC

(1) CHANNEL : You can select a channel which you want to change values.

(2) TITLE : You can name each camera with 8 digit numbers or letters combination.

Move a cursor onto a location that you want and choose numbers or letters by using mouse wheel or left/right button of a mouse. To exit to the previous menu mode, click 'ESC'.

DEFAULT = CAM01__ ~ CAM03__

(3) COLOR : You can adjust color of image display of each camera by a mouse.

BRIGHTNESS : Adjusting brightness (-32 ~ 31) [DEFAULT = 0]

CONTRAST : Adjusting contrast (-32 ~ 31) [DEFAULT = 0]

SATURATION : Adjusting saturation (-32 ~ 31) [DEFAULT = 0]

HUE : Adjusting hue (-32 ~ 31) [DEFAULT = 0]

(4) Executing Buttons

ALL : Initializing all values for all channel as a default setting value.(CH1 ~ CH4)

DEFAULT : Initializing all values for the applied channel only as a default setting value.

ESC : Used to exit

4) MOTION SETUP

MOTION SETUP

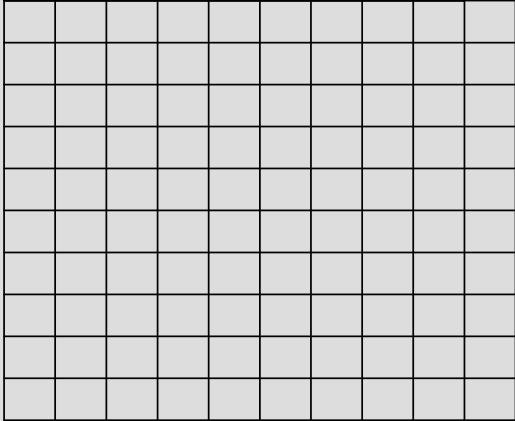
CHANNEL	CH1	
SENSITIVITY	5	
DURATION	05	
DETECT		
CELL NUM.	01	
DEFAULT ALL-DEFAULT ESC		

MOTION SETUP : You can change values by mouse wheel and left/right button of a mouse.

- SENSITIVITY : Adjusting sensitivity of a movement. You can adjust level 1 ~ level 5. [DEFAULT : 1]
- DURATION : Whenever motion is detected and it is set at Motion Recording mode, DVR records for a certain time being from the point of time when motion is detected. (1 sec.~99 sec.) [DEFAULT : 1 sec.]
- DETECT CELL NUM. : Select the minimum of CELL for MOTION EVENT to be activated.
- ALL-DEFAULT: Default setup for all channels

MOTION MASK SETUP : Set motion detection area.

- CELL : Move to the location which you don't want to detect and then click it by using left button. Motion is detected, when the cell is activated. Motion is not detected on non-activated cells.
- BLOCK ON : Select non detection area by block. (The blocked cells are non-activated area) By clicking left button and dragging a mouse, you can block the cells. The right button is used for delete the blocked cells. To save the setting value and exit, click 'ESC'.
- BLOCK OFF : Select detection area by using the right button of a mouse. The right button is used for delete the blocked cells. To save the setting value and exit, click 'ESC'.

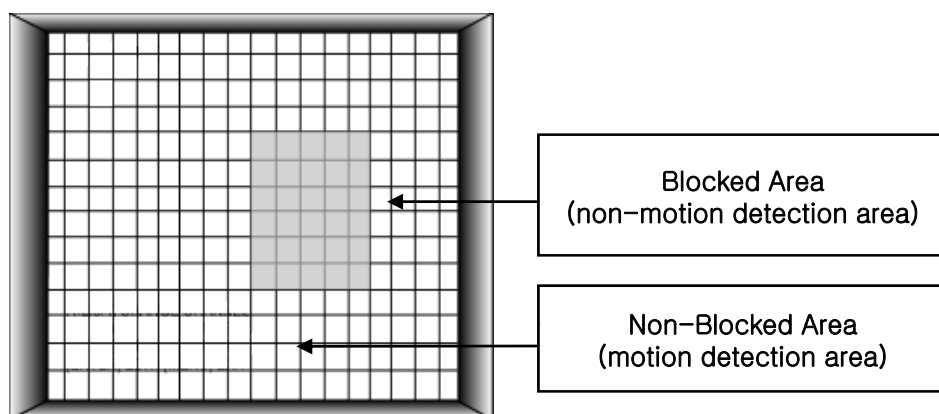

5) INTERVAL SETUP

See the switching time interval for SEQ or PIP function.
(1 sec. ~99 sec.)

SEQUENCE SCREEN :Set the sequencing switch time interval in live full screen.

PIP SCREEN : Set the sequencing switch time interval of PIP window.

EVENT UPDATE : Set the minimum time interval of event to be listed on EVENT LIST.

If EVENT UPDATE time is set at 5 sec, only following event happened 5 sec or more than 5 sec later previous event shall be listed on EVENT LIST.

INTERVAL SETUP	
SEQUENCE SCREEN	01 SEC
PIP SCREEN	01 SEC
EVENT UPDATE	600 SEC
	DEFAULT ESC

6) ALRAM SETUP

Set type of alarm sensors connected to DVR unit.
N.O represents Normal Open type and N.C Normal Close type.

INPUT : Select NORMAL OPEN, NORMAL CLOSE, or DISABLE.
DISABLE represents not to use alarm sensor connected to DVR.

DURATION : Set the duration of alarm when an ALARM is activated. (0 sec. ~ 300 sec.)

ALRAM SETUP	
CHANNEL	CH1
INPUT	DISABLE
DURATION	01 SEC
	ALL-DEFAULT DEFAULT ESC

7) PASSWORD SETUP

Set user ID and Password.
You can make up to 8 digit number combination for a password by clicking number '0' ~ '9' on password setup menu.

To change password, you need to click 'USER PW' first to activate the menu.

You must input current password and then input new password.
And input again new password to confirm.

PASSWORD SETUP											
USER ID	ADMIN										
USER PW	-----										
NEW PW	-----										
CONFIRM	-----										
<table border="1" style="width: 100%; text-align: center;"> <tr> <td>0</td><td>1</td><td>2</td><td>3</td><td>4</td><td>5</td><td>6</td><td>7</td><td>8</td><td>9</td> </tr> </table>		0	1	2	3	4	5	6	7	8	9
0	1	2	3	4	5	6	7	8	9		
	ENTER ESC										

Number selection for password

※ Changing the user Password in the first operation is recommended.

5-5. EXTERNAL DEVICE

Set parameters of external devices connected to DVR like Ethernet, PTZ camera, Spot monitor etc. If you click ETERNAL DEVICE on the main menu, then you will see the window shown on the right.

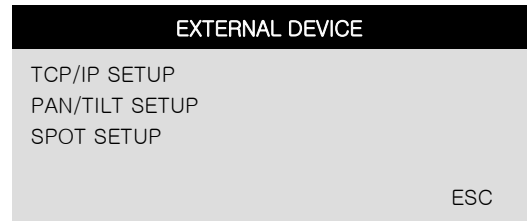

1) TCP/IP SETUP

TCP/IP function enables you to see live pictures and recorded pictures via internet.

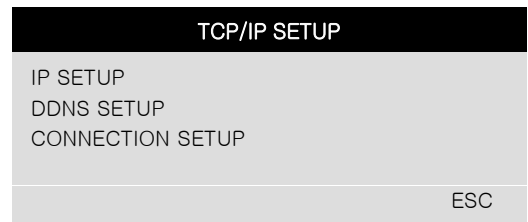

(1) IP SETUP :

Shows the network information assigned to the DVR unit. If the DHCP setup status is AUTOMATIC, you can set the IP port only and if the DHCP setup status is MANUAL, you must set all parameters. If IP port number is blocked, a network specialist's advice is needed.

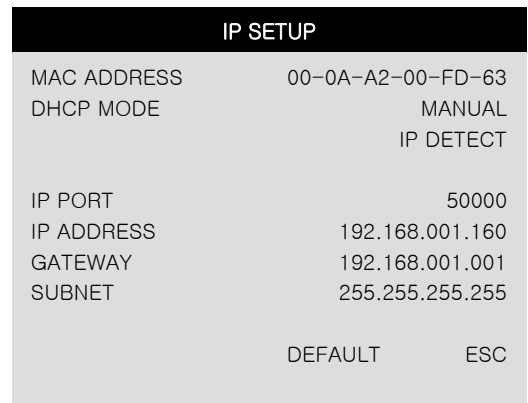

2) PAN/TILT SETUP

PAN/TILT SETUP	
COMMAND SETUP	← PTZ Camera setup
SPEED SETUP	← PTZ Speed setup
ESC	

PAN/TILT SETUP	
PAN SPEED	7
TILT SPEED	7
ZOOM SPEED	7
FOCUS SPEED	7
DEFAULT ESC	

COMMAND SETUP	
CHANNEL	01
MODEL	PELCO-D
PTZ ID	000
BAUDRATE	2400 BPS
CMD DELAY	1 MSEC
COMMAND	PAN/TILT STOP
LENGTH	16
CODE	00 00 00 00
	00 00 00 00
	00 00 00 00
	00 00 00 00
DEFAULT	ALL-DEFAULT ESC

- 1) CHANNEL : Select channel
- 2) MODEL : Select camera model (protocol type) per each channel
- 3) PTZ ID : Select PTZ ID (per each channel)
- 4) BAUDRATE : Select data transmission speed
- 5) CMD DELAY : Select command delay time

3) SPOT SETUP

SPOT SETUP	
SWITCH INTERVAL	03 SEC
ALARM POP UP	ON
MOTION POP UP	ON
EVENT POP UP DURATION	05 SEC
DEFAULT ESC	

- (1) SWITCHING INTERVAL
Channel switching time (01 sec. ~ 99 sec.)
- (2) ALARM POP-UP
When ALARM is detected, the image of channel connected with Alarm sensor pops up.
Set ALARM detection pop-up (ON/OFF)
- (3) MOTION POP-UP
Set MOTION detection pop-up (ON/OFF)

※ EVENT POP-UP DURATION
Set EVENT POP-UP DURATION

If events (MOTION or ALARM) happen on several channel at the same time, channel No. 1 has the first priority to pop up. For example, if events happen on channel No. 1, channel No. 2, and channel No. 4 at the same time, channel No. 1 pops up. If the motion disappears on channel No. 1, then channel No. 2 pops up for the duration that you set. However, even though motion happens on channel No. 1 again within the duration, channel No. 2 still displays. If motion on channel No.1 keeps on going even after the duration, channel No. 1 pops up again.

5-6. BACK-UP

1) CDR SETUP

You can back up the recorded data to CD using CD writer installed in DVR.

Refer to [START] and [END] of data on HDD and set copy from time, [START], and size of data copied, [SIZE], and move to BURN and click it to start copy.

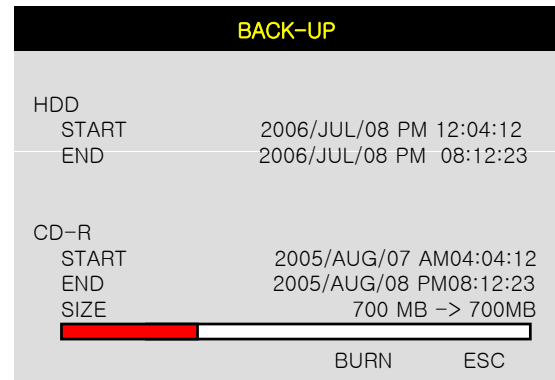
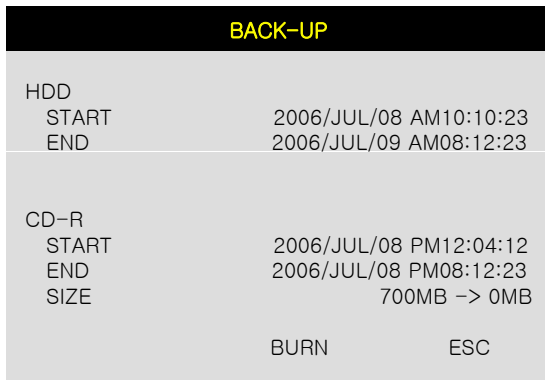

System Status Messages :

1. INPUT BLANK CD : CD writer has no blank CD.
2. CD-R MEDIA IS DETECTED : A blank CD-R media has been inserted and detected.
 CD-RW BURNING START
 CD-RW BURNING LEAD-IN
 CD-RW BURNING IMAGE DATA
 CD-RW BURNING CLOSE TRACK
 CD-RW BURNING COMPLETE
3. When burning is completed, CD-R media will be ejected automatically.
4. To copy more images, repeat above process. In the next back-up process, [START] time in CD-R sub-menu shall be [END] time in previous back-up, and you can copy images in series to many CDs as many as you want.

2) USB SETUP

User can back up the recorded data to USB Media using USB (HOST) port on front panel of DVR. Refer to [START] and [END] of data on HDD and set start and end time of data to USB Media (Memory Stick or USB HDD). Select backup file size, and move to BACKUP and press [ENTER] Button to start copy.

USB HDD control only : Partition can be selectable by Ch button 1~4.

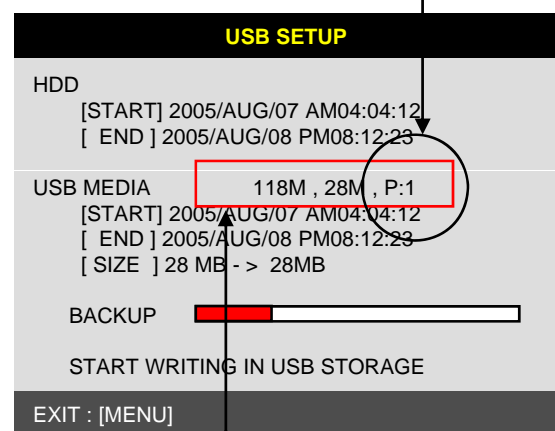
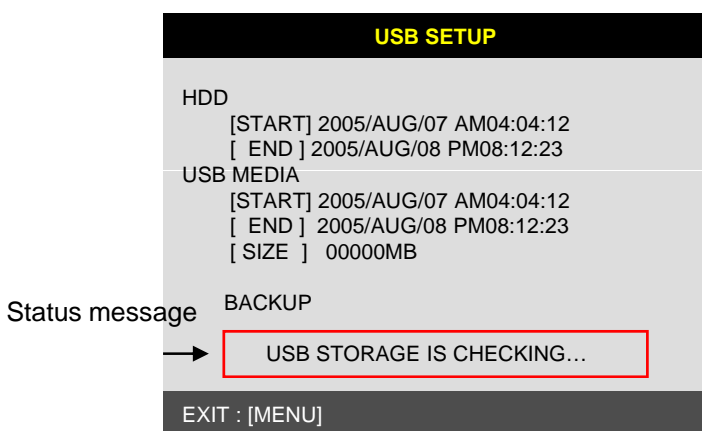

SIZE , FREE SPACE, PARTITION

System Status Messages

- (1) If MEMORY STICK is not inserted :
 - USB STORAGE IS CHECKING...
 - USB STORAGE IS NOT AVAILABLE
 - RE-CONNECT THE USB STORAGE
 - CONECT THE OTHER USB STORAGE
- (2) When MEMORY STICK or USB HDD is recognized
 - USB STORAGE IS CHECKING ...
 - THERE IS A FREE SPACE ON STORAGE
 - USB STORAGE IS AVAILABLE
- (3) During Back-Up
 - CHANGE WRITE PROTECT MODE (Only WRITE PROTECT is caught, it can be seen)
 - START WRITING IN USB STORAGE
 - FINISH WRITING IN USB STORAGE
- (4) Error Message
 - THERE IS A PROBLEM ON USB PORT (If USB PORT fails to work properly)
 - USB STORAGE IS FULL (When USB is full)
 - FILE SYSTEM IS NOT SUPPORTED (If File System is not supported)
 - SIZE IS LARGER THAN FREE SIZE (If back-up size is larger than free space)

※ Back-Up procedure is the same as CDR Back-Up.

※ If Back-Up size is larger than 2GB, it creates several files. (It saves by 2GB).

5-7. FIRMWARE UPGRADE

You can upgrade your DVR with a firmware by using CD-RW.

Go to FIRMWARE UPGRADE menu and insert a CD containing a firmware.

First, you click 'CD-CHECK'. After finishing 'CD-CHECK', click 'UPGRADE'. After you see a message 'POWER OFF AND POWER ON' at the bottom, then turn off and on your DVR unit to finish upgrading and restart the system.

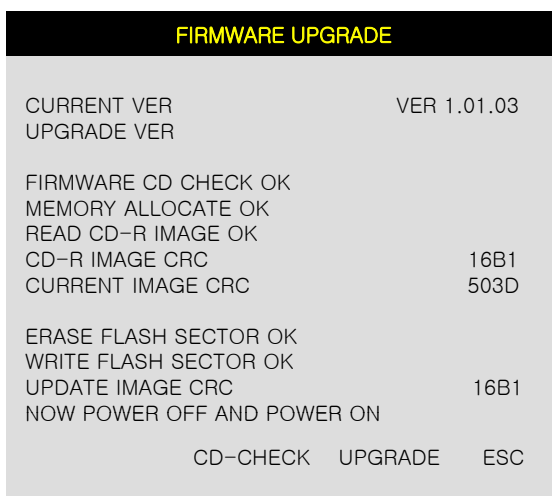

CHAP. 6 Network Setup

6-1. DVR Network Configuration

Please call your provider to identify what type of service they are providing you. You will need to know following :

Upload speed – For your own knowledge for expected frame rates.

Download speed – For your own knowledge for expected frame rates.

Addressing – For determining what scenario you should follow.

Router ON Site or Just a Modem – For determining what scenario you should follow.

※NOTE : If your provider is using PPPoE (usually DSL providers), you MUST have a router installed on site and follow CASE C For DVR setup and access.

※Please verify Internet access after installing any new equipment (routers, switches, modems etc)

PC's TCP/IP Setting

Before configuring the DVR, please fill out the information below if applicable:

Choose any PC on your network and determine its TCP/IP settings:

IP Address : _____ (ex.192.168.1.5)

Subnet Mask : _____ (ex. 255.255.255.0)

Default Gateway : _____ (ex.192.168.1.1)

Next pages are several network scenarios. Please identify which scenario your current network falls within and follow the instructions for configuring and accessing your DVR via TCP/IP.

TCP/IP function enables you to see live pictures, recorded pictures and also allows you to backup, and control a PTZ camera via internet.

[How to set Network depending on ISP](#)

1. Static IP

User input IP address in IP CONFIG SETUP which is assigned from ISP company.

- 1) Verify if IP address is OK or not with PC before connecting DVR.
- 2) Connect LAN cable to DVR after confirmation.
- 3) DVR : MENU→EXTERNAL DEVICE→TCP/IP.
- 4) Set DHCP to MANUAL and go into TCP/IP SETUP.
- 5) Verify if MAC ADDRESS starts from 00-0A-A2...
- 6) Input IP address which is assigned from ISP company.
- 7) Set IP PORT. (50000 recommended)
- 8) Input GATEWAY which is assigned from ISP company.
- 9) Input SUBNET MASK which is assigned from ISP company.
- 10) Go out of MENU SETUP.
- 11) Turn off and on Modem (Router) which is provided by ISP company.
→ This is to reset client of MAC from ISP company.
User have to wait for 30 seconds after turing on.
- 12) Access DVR with Remote Viewer Software.

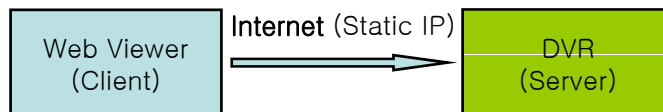

- * If user fail to access, please verify 1,6,7,8,9,11 again.
- * When speed is too slow and connection fails after access : MENU →EXTERNAL
Increase value of Timeout to find the most suitable speed.

2. Dynamic IP

If you set 'AUTOMATIC' for DHCP Type on TCP /IP setup menu, IP information is automatically assigned from ISP's DHCP.

- 1) Verify if IP address is OK or not with PC before connecting DVR.
- 2) Connect LAN cable to DVR after confirmation.
- 3) Turn off and on Modem (Router) which is provided by ISP company.
-> This is to reset client of MAC from ISP company.
User have to wait for 30 seconds after turning on.
- 4) Turn off and on DVR.
- 5) DVR: MENU→EXTERNAL DEVICE→TCP/IP.
- 6) Verify if MAC ADDRESS starts from 00-0A-A2...
- 7) Set DHCP to AUTOMATIC and detect IP to get Dynamic IP.
- 8) Go out of MENU SETUP after getting IP successfully.
- 9) Access DVR with Remote Viewer Software.

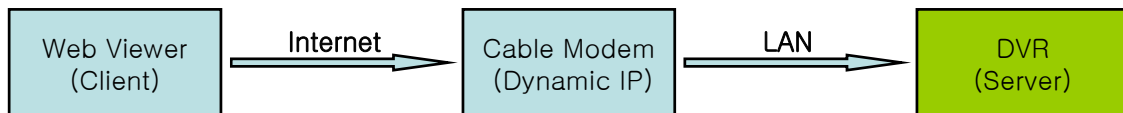

- * If user fail to access, please verify 1,3,4 again.
- * When speed is too slow and connection fails after access : MENU → EXTERNAL DEVICE → TCP/IP SETUP → CONNECTION SETUP.
Increase value of Timeout to find the most suitable speed.

3. Dynamic IP of PPPoE (DSL)

DVR doesn't support DSL(PPPoE), user have to set NETWORK with IP SHARE if user need to access DVR remotely. At this time, user have to port forward on DVR. Please contact IP SHARE Manufacturer if You need to know how to forward port.

Even though user have Static/Dynamic IP, if user want to use another device (PC) through IP SHARE, User can set NETWORK as follows,

- 1) Verify if IP address is OK or not with PC before connecting DVR.
- 2) Connect Router (IP SHARE) to DSL modem as shown the following picture.
- 3) Set the internet connection on Router (IP SHARE). (Refer to the Router Manual).
- 4) Verify if sub-group of network in Router is OK or not.
- 5) Connect DVR to Router.
- 6) DVR : MENU →EXTERNAL DEVICE →TCP/IP.
- 7) Set DHCP to MANUAL and go into TCP/IP SETUP.
- 8) Verify if MAC ADDRESS starts from 00-0A-A2...
- 9) Input internal IP address which user assigned from Router.
- 10) Set IP PORT, (50000 recommended)
- 11) Input GATEWAY of Router.
- 12) Input SUBNET MASK of Router.
- 13) Go out of MENU SETUP.
- 14) Forward port from Router.(Refer to the Router Manual.)
- 15) Access DVR with external IP and Port (Port forwarded).

* If Router support DDNS, user can access Remote Viewer using Domain Information.

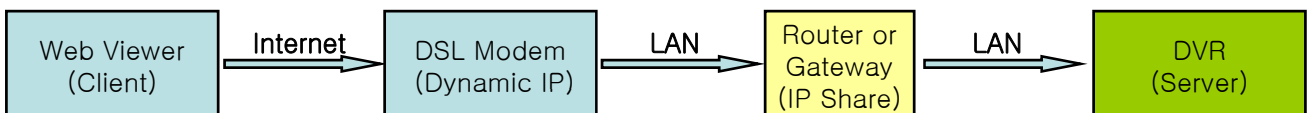

- * If user fail to access, please verify 1,4,15 again.
- * When speed is too slow and connection fails after access : MENU →EXTERNAL DEVICE →TCP/IP SETUP →CONNECTION SETUP
Increase value of Timeout to find the most suitable speed.

6-2. Remote Viewer program

MAIN INTERFACE

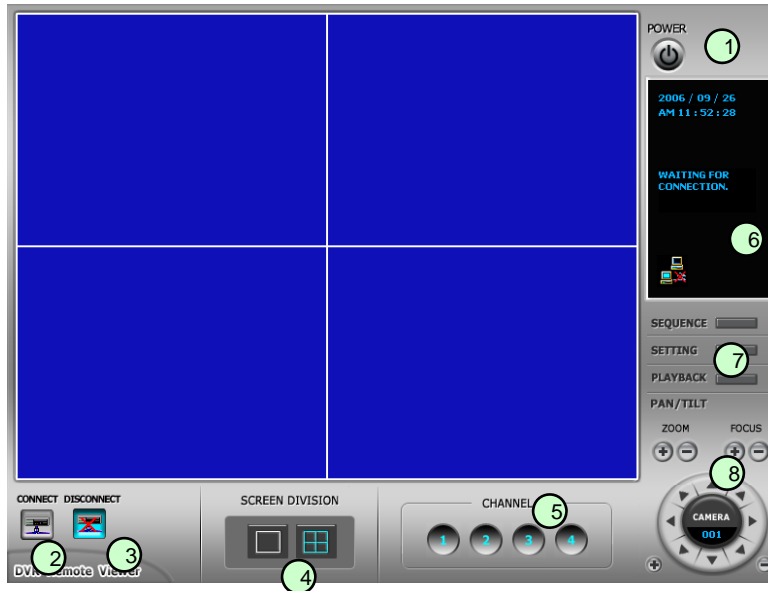

- ①- **Power button** : Press the Power switch to exit the program. Please disconnect the live feed before powering off the software
- ②- **Connect button** : Press the Connect button to view the live images from the DVR. These are the same images being displayed on the monitor of the DVR, with a delay depending on your internet connection at both the DVR location and from where you're currently accessing.
- ③- **Disconnect button** : Press this button to disconnect from the DVR unit. Then you may power off the software.
- ④- **Screen Division button** : Select how many channels to view simultaneously (single, 4-split).
When you select a view you will see the Channel Numbers highlighted which determine what channels are currently being viewed.
- ⑤- **Channel number button** : Select the channel that you want to view based on what Screen Division view is enabled.
- ⑥- **Status window** : Display's the current time and date based. The date is in the format : Year/Month/Day.
You will also see the status of your connection.
- ⑦- **Setting, Playback, and Sequence buttons** ; a. Setting : Enables the software configuration screen.
b. Playback : Enables the remote playback screen.
c. Sequence : When in single channel view, hitting the sequence button will sequence through all active channels at a speed specified in the settings menu.
- ⑧- **PTZ control** : You can control a PTZ camera via the software with these controls.
 - a. First, you must input or configure the specific PTZ protocol into the software in order to communicate with the PTZ device.
 - b. When you press any of the controls for the PTZ, please press and hold the button for 1-2 seconds per instance to compensate for the data transmission rate. If you do not and instead simply click the PTZ buttons, you may get undesired results (having the requested operation transmitted repeatedly, regardless of your intention).
 - c. The plus and minus buttons send the PTZ commands to the corresponding PTZ camera ID.

IP/PORT Setting Screen

Remote Viewer Setup

IP/PORT | DDNS | SAVE

NAME: INTRANET MANUAL DDNS

ADDRESS: 218.146.23.250 PORT: 247

USER ID: admin PASSWORD:

NAME	IP	PORT
INTERNET	192.168.1.160	50000

Save Delete

OK Cancel

→ IP List

**MANUAL
DDNS**

Input IP address and PORT manually
 Receive IP address and PORT from DDNS Server.
 For further information of DDNS, please contact your vendor.

**Name
Address
PORT
ID
Password**

Name of IP address on the list.
 Input IP address which is set on DVR
 Input PORT which is set on DVR
 Input ID which is set on DVR. (Please input 'admin'.)
 Input password which is set on DVR

IP List It shows IP list which user input manually.

Select Button Select IP and PORT on the list.

Save Button Save IP and PORT on the list.

Delete Button Delete IP and PORT on the list.

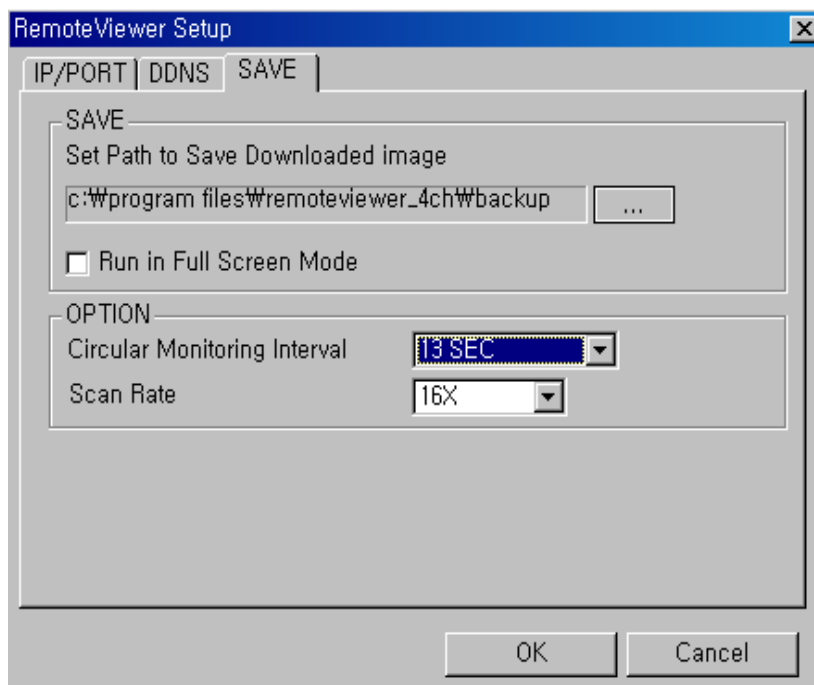
PTZ/SAVE Setting Screen

Circular Monitoring Interval : This indicates the speed of the channels sequence when the SEQUENCE button is used from the main interface.

Scan Rate : Set speed of playback.

Set Path to Save Downloaded image : Determines the location and folder on your PC where the downloaded video clips are stored.

Run in full screen mode : When checked, this will enable the program to re-adjust the interface to completely fill your computer screen.

PLAYBACK INTERFACE through Remote Viewer

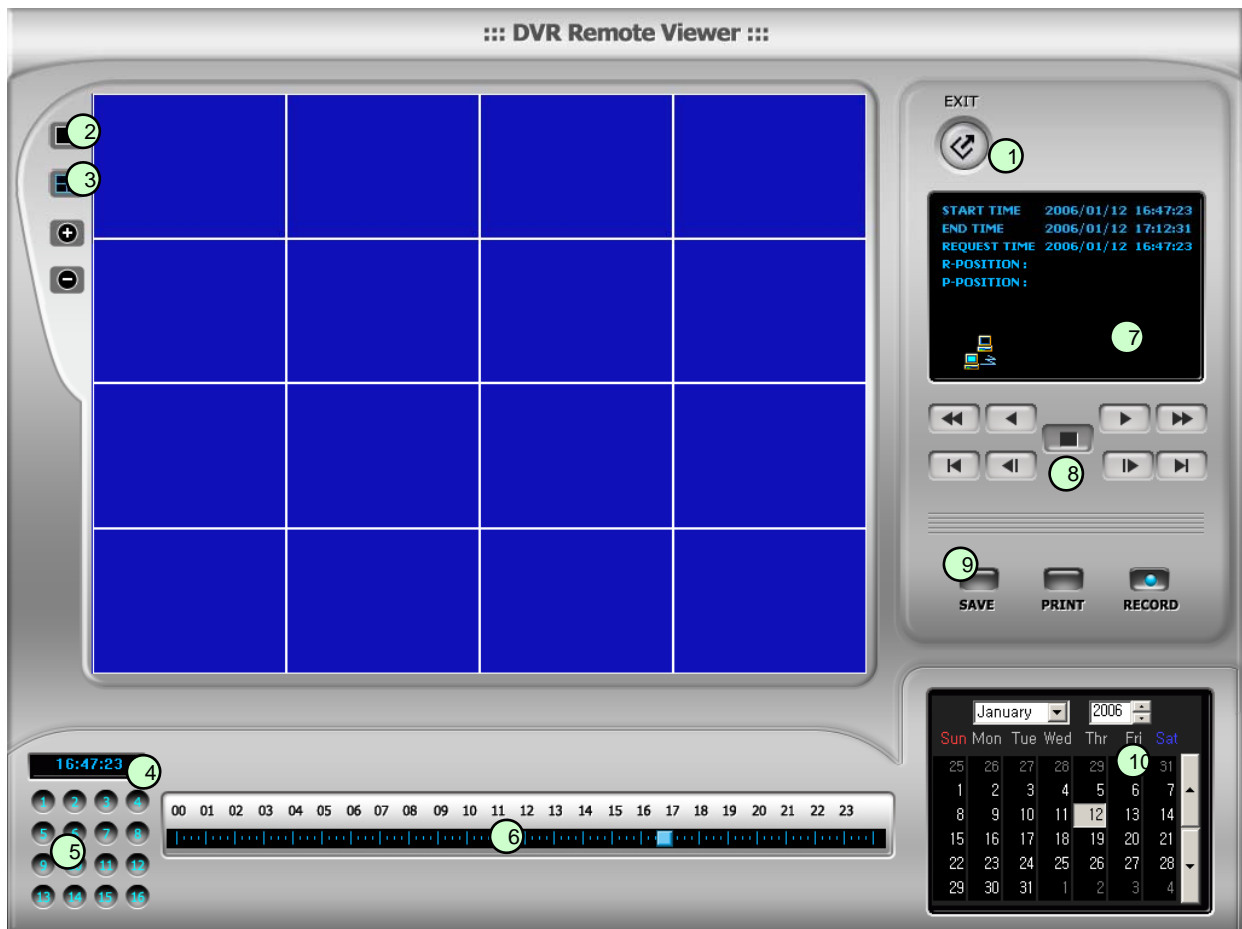



Function of each button in Search window.

- ① **Exit** : Exit to live window.
- ② **Full screen** : Select a certain camera to view in full screen.
- ③ **Quad** : To view quad mode (4 channels at the same time)
- ④ **Time** : The recording time & date information of the pictures which is being played.
- ⑤ **Channel selection** : Select each camera.
- ⑥ **Time selection** : Select a time from which user want to see. The playback will be started from this point.(drag the point using mouse)
- ⑦ **Start and end time** : Indicate record starting time and end time of images on HDD
- ⑧ **Other operating button** : Refer to the next page description.



 : Play fast backward

 : Play backward(1X)

 : Play forward(1X)

 : Play fast forward

 : Stop playback

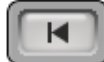
 : Move to the start of recording

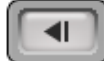
 : Move to the previous hour

 : Move to the afterward hour

 : Move to the end of recording

⑨ Command button.

a) SAVE : After pressing the Stop button, click SAVE button to save the currently viewed image in jpg format.

b) PRINT : After pressing the Stop button, click PRINT button to print the currently viewed image.

c) RECORD : Press this button to download playback images transmitted from DVR unit into your PC. User can see saved images using Windows Media Player.

⑩ Calendar

Use this to select the date you wish to search. The filled in square outlines the date that is at the beginning of the hard drives. The outlined square indicates the data at the end of the hard drives. Select the date you wish to view. Verify a filled in square for that particular date. If an invalid date is selected it will default to the beginning of the hard drive(s).

6-3. Back-up CD Player

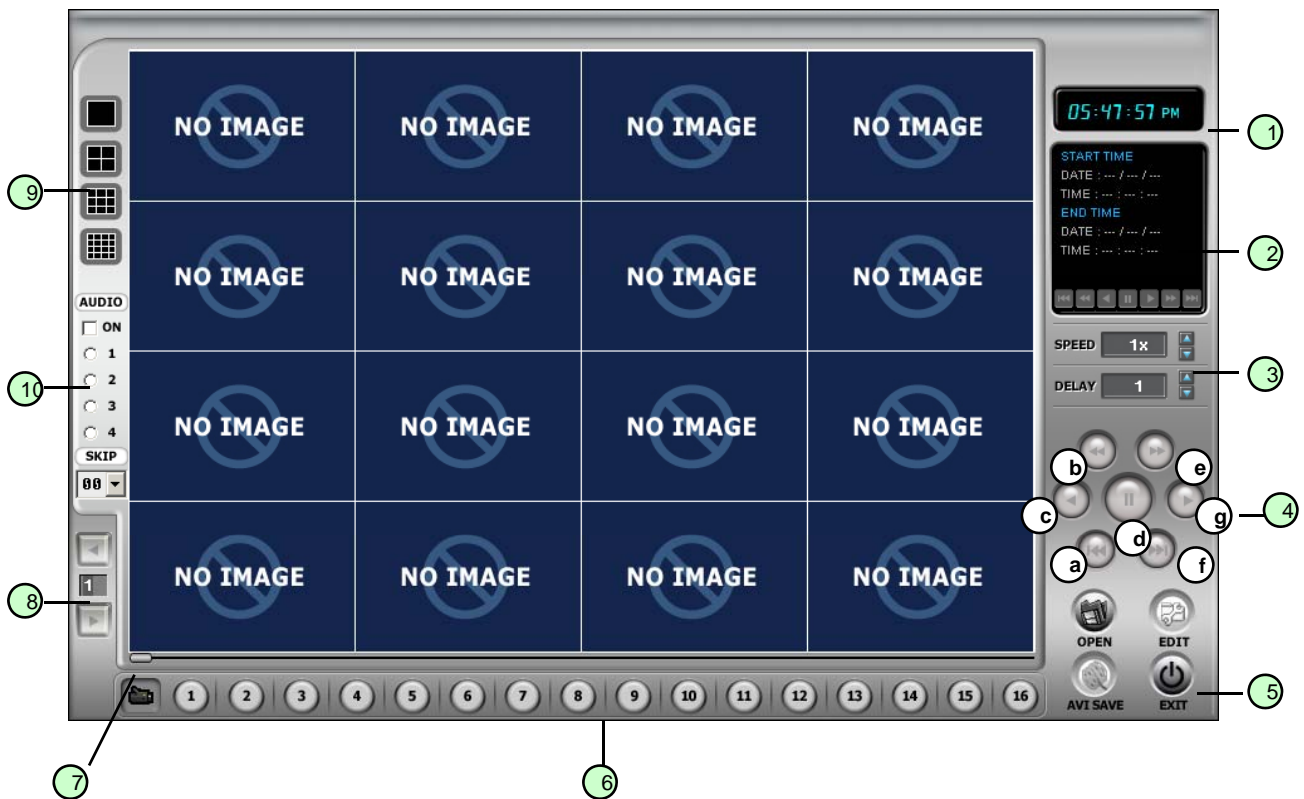

DVR units are with a built-in CD-RW, and user can copy images to CD.

Using back-up CD player, user can see images on back-up CD, and function of each button in Back-up CD player is as below.

- ① **Time** : Current time.
- ② **Status Window** : Start & End of time & date, Status of operating button.
When user play forward/backward, recorded time will appear.
- ③ **Play Speed button** : User can adjust play speed by pressing up/down button.
Speed (1/4X, 1/2X, 1X, 2X, 4X, 8X, 16X) Delay : (1, 2, 4, 8, 16, 32)
- ④ **Operation button** : User can search recorded data using these buttons.
 - a) Move the slide bar to start position
 - b) Play fast backward in preset speed
 - c) Play backward at 1x speed
 - d) Pause
 - e) Play forward at 1x speed
 - f) Play fast forward in preset speed
 - g) Move the slide bar to end position
- ⑤ **Function button**
 - a) OPEN : Open the Back-up CD Player.
 - b) EDIT : User can edit, save and print recorded image on Edit mode. This edit button will work when you selected one of 16 cameras.
 - c) EXIT : Exit from Back-up CD Player.
- ⑥ **Channel button** : Select channel to see pictures in full screen.
- ⑦ **Slide Bar** : Move to a point from which user want to see.
- ⑧ **Page button** : This button is just working when screen-division is 4-split in 8 ch DVR, or 4-split or 8-split in 16 ch DVR. Moves to next page.
- ⑨ **Screen division** : 1/4/9/16

⑩ When you open the file, audio menu OSD will come up automatically.

- on : check to output recorded sound, then choose the audio channel 1,2,3 or 4

- skip : skip images forward.

* During playback, you can control  only.

* During playback, only one channel is displayed and can not be changed to multi or full screen.

Image EDIT

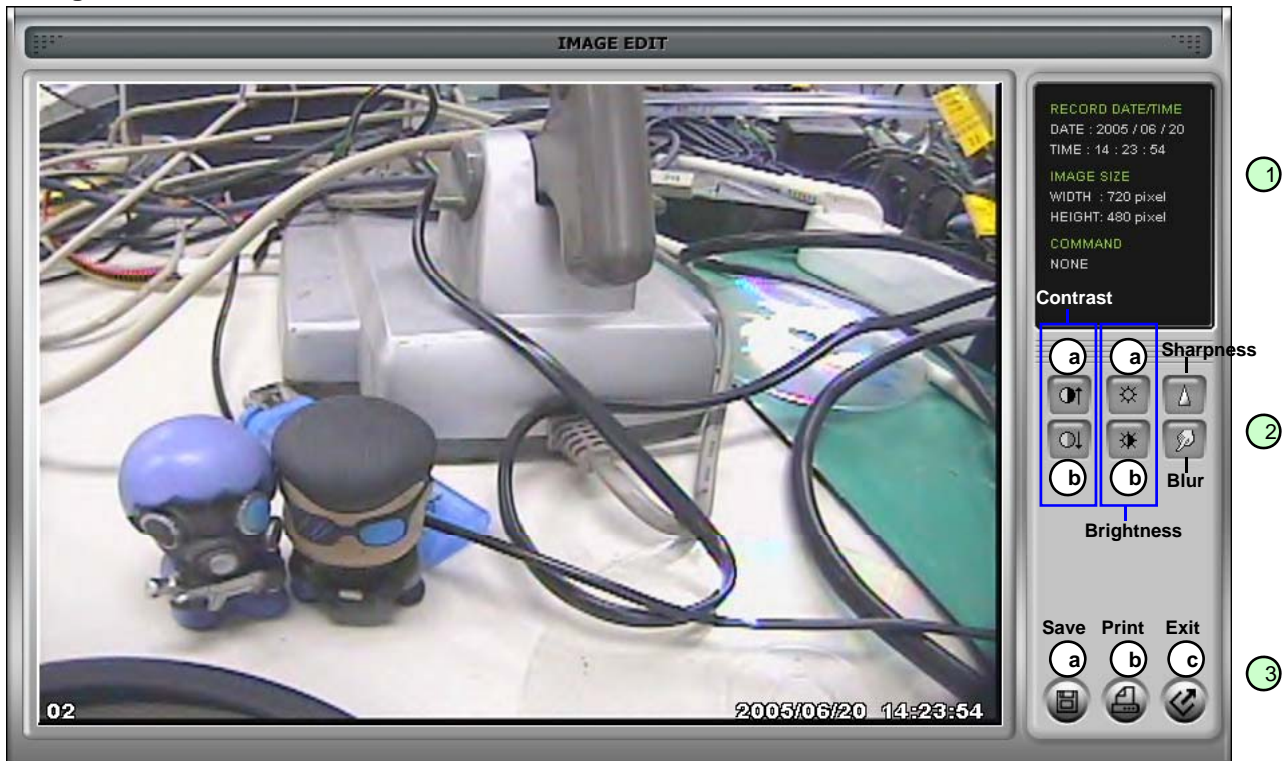

① **Image Edit Status Window** : Shows record time & date, Image size, Command status.

② **Edit Button** : User can adjust color tone of copied images using this button.

- Contrast :

a) make bright part of image brighter and dark part of image darker

b) To reduce light and shade, lower contrast a little

- Brightness

a) make an image brighter

b) make an image darker

- Sharpness : give sharp-edge effect

- Blur : make an image soft

③ **Function button**

a) Save : User can save an image in JPEG format. It is saved in the folder where you installed back-up CD player.

b) Print : User can print current image user selected

c) EXIT : Return to Back-up CD Player mode.

CHAP. 7 Web-Viewer Setup

7-1. Registering DVR for DDNS (DDNS Web-server)

1) Please access www.j2kip.com and click Register Member ID.

Member Login

This website was created to provide a dynamic domain name system (DDNS) that allows DVR Systems to operate without a static IP from an Internet provider. This has been created exclusively for use with the Argus line of products. Complete the registration process to add your DVR to the system and enjoy the many benefits of DDNS.

Member ID

Password

[Forgot Password](#) [Register](#)

Member Register > New user

* ID and Password must be three characters or more
* We use User Email address to send information(User ID and Password) about your account.

Member Id

User Email

User Password

Confirm Password

2) Please click DVR Add to register DVR.

DDNS service [Home] [Logout] [Member Edit]

DYNAMIC DOMAIN NAME SYSTEM



DDNS Services for DVR Systems

This website was created to provide a dynamic domain name system (DDNS) that allows DVR Systems to operate without a static IP from an Internet provider. This has been created exclusively for use with the line of products. Complete the registration process to add your DVR to the system and enjoy the many benefits of DDNS.

Welcome demotest

Member

- [Member Register](#)
- [My Dvr List](#)
- [My DVR Register](#)
- [DVR Web Client](#)
- [DVR Web Backup](#)
- [DVR Web Backup player](#)

My DVR List

* Click Web-Viewer icon on the right side of ACT to operate Web-Viewer.
* You should add www.j2kip.com on Trusted Sites(Tools -> Internet Options -> Security) at first webviewer installation.
* : Webviewer : Webbackup : Dvr Edit : Dvr Delet

DVR Name DVR Add

No	Name	MAC	IP:Port	Last Modified	Act
No Data					

3) Please click confirm after inputting DVR information (DVR Name and MAC Address only). Then, Click "confirm" button.

My DVR Register

* Mac Address should be listed correctly without dash "-".
 * Mac Address already listed can not be registered again.

DVR Name	<input type="text" value="superman"/>
MAC Address	<input type="text" value="000AA200F00C"/> *without dash "-"
IP Address	<input type="text"/>
IP Port	<input type="text"/>
<input type="button" value="Confirm"/>	

4) Now, DVR is listed on DDNS web server without IP and Port number.

DDNS service
DYNAMIC DOMAIN NAME SYSTEM

[Home] [Logout] [Member Edit]



DDNS Services for DVR Systems
 This website was created to provide a dynamic domain name system (DDNS) that allows DVR Systems to operate without a static IP from an Internet provider. This has been created exclusively for use with the line of products. Complete the registration process to add your DVR to the system and enjoy the many benefits of DDNS.

Welcome jason

Member

- Member Register
- My Dvr List
- My DVR Register
- DVR Web Client
- DVR Web Backup
- DVR Web Backup player

My DVR List

* Click Web-Viewer icon on the right side of ACT to operate Web-Viewer.
 * You should add www.j2kip.com on Trusted Sites(Tools -> Internet Options -> Security) at first webviewer installation.
 * : Webviewer : Webbackup : Dvr Edit : Dvr Delet

DVR Name DVR Add

No	Name	MAC	IP:Port	Last Modified	Act
1	superman	00-0A-A2-00-F0-0C	:	2006-01-09 3:23:57	

1

7-2. DDNS set up in DVR

- * The following setting is a sample for a cable modem connected to DVR directly.
- 1) Go to Menu
 - 2) Go to IP SETUP menu, if you set DHCP AUTOMATIC then, it detects IP address automatically.

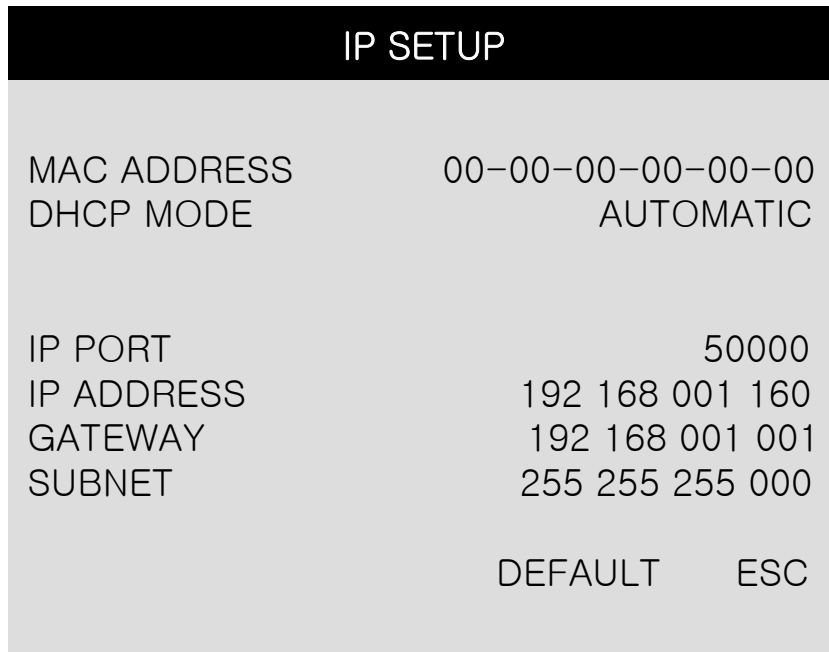

- 3) Go to the previous menu and click DDNS SETUP.



4) Set DDNS ON/OFF 'ON'.

IP address which is assigned from DHCP server is automatically input on DNS SERVER.

DDNS SETUP					
DDNS ENABLE					ON
DNS SERVER					192.168.063.001
INTERVAL					D-00 H-00 N-20 REGISTER
DDNS STATUS					REGISTER OK
IP ADDRESS					192.168.001.160
IP PORT					50000
REMAIN TIME					D-00 H-00 N-20
LAST REGISTRATION DATE					
> WED.	12	JUL	2006	09 : 21 : 36	GMT
				DEFAULT	ESC

5) Go down to REGISTER and push ENTER button to renew IP registered on DDNS SERVER.

(Interval : connection interval time between DVR and DDNS SERVER)

D = Day, H = Hour, M = Minute

DDNS SETUP					
DDNS ENABLE					ON
DNS SERVER					192.168.063.001
INTERVAL					D-00 H-00 N-20 REGISTER
DDNS STATUS					REGISTER OK
IP ADDRESS					192.168.001.160
IP PORT					50000
REMAIN TIME					D-00 H-00 N-20
LAST REGISTRATION DATE					
> WED.	12	JUL	2006	09 : 21 : 36	GMT
SUCCESS TO REGISTER DVR INFO					
				DEFAULT	ESC

6) Go to your computer again after you see “SUCCESS TO REGISTER DVR INFO” and then Click ‘refresh’ button. Then, DDNS server automatically catches your DVR’s IP address and Port number.

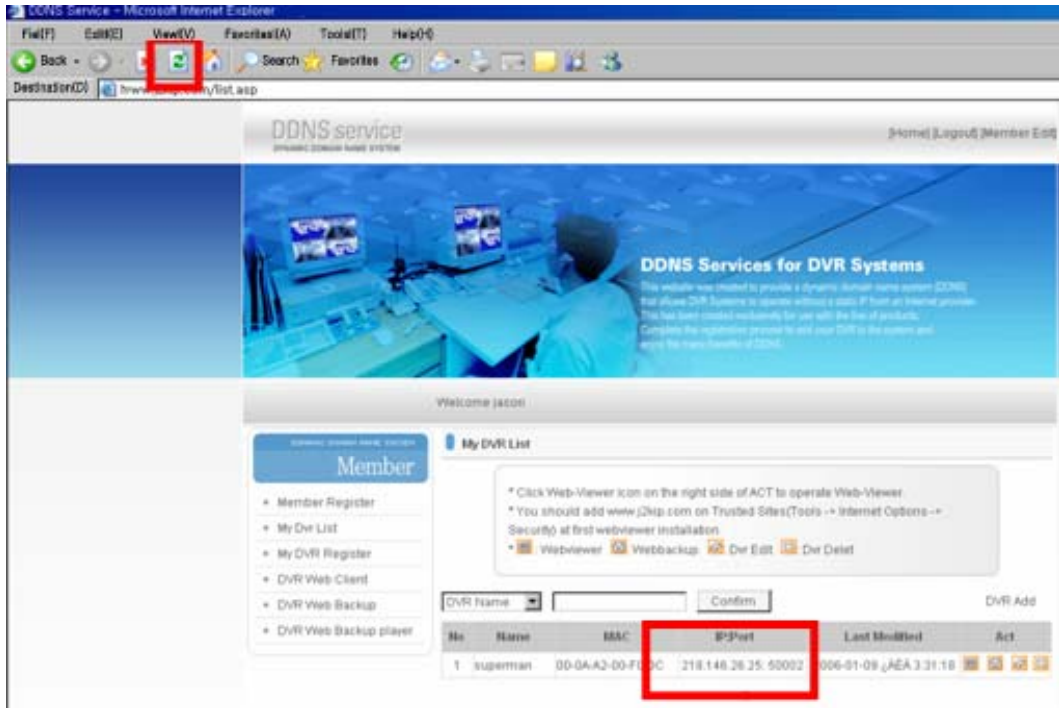

Note.

Before using Web-Viewer, please add www.i2kip.com on Trusted Sites at first installation as follows. (Tools -> Internet Options -> Security)

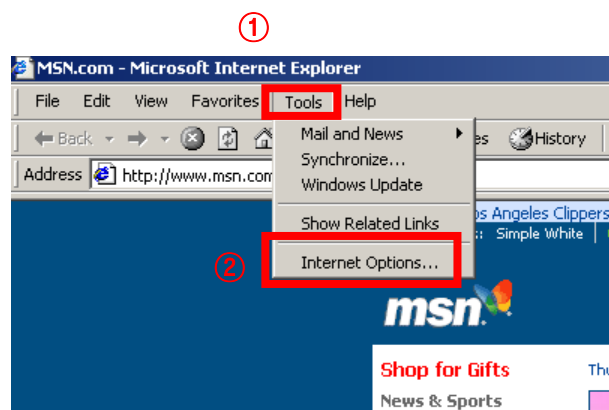

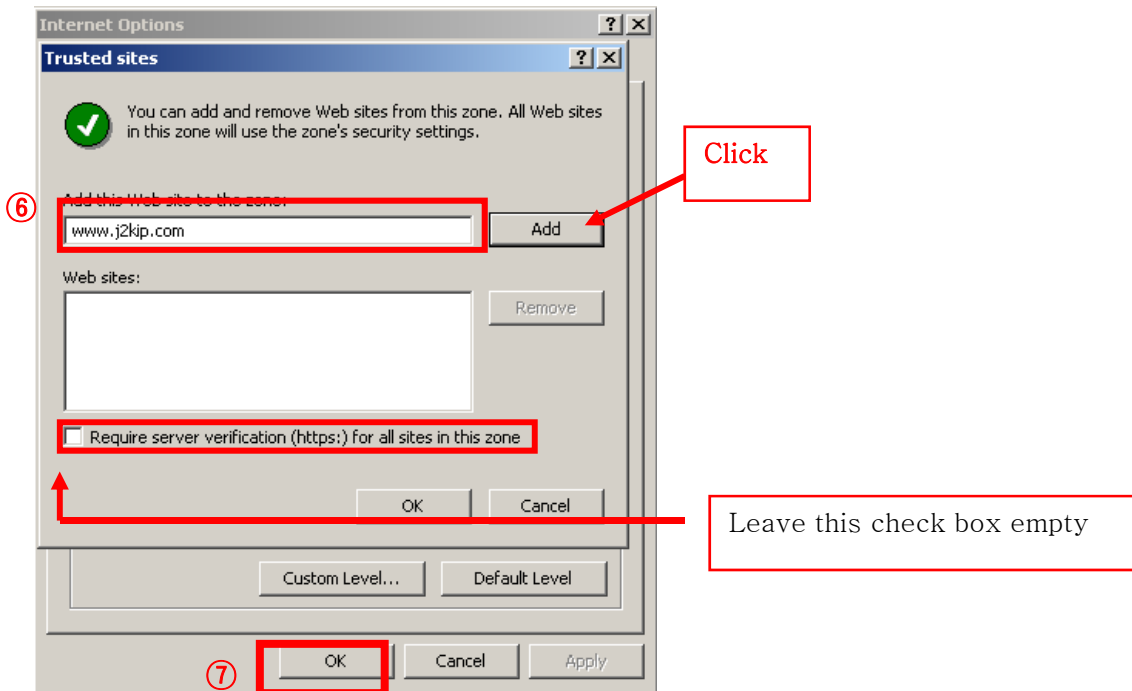
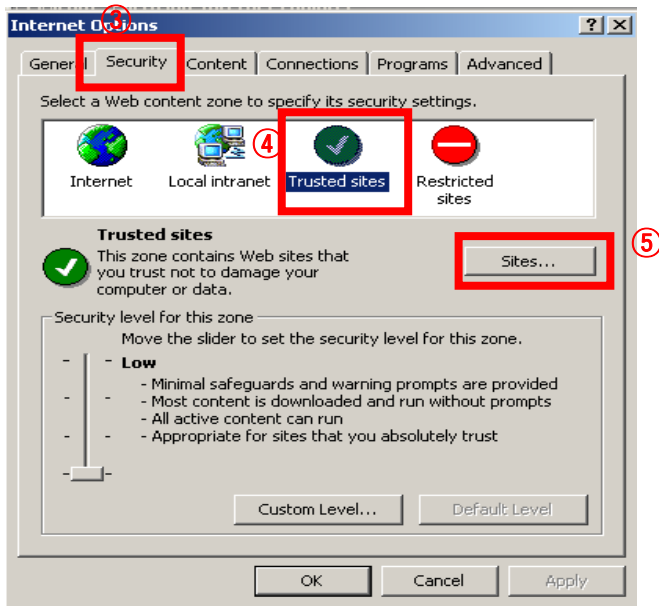

7-3. Web Viewer

1) Please click the following icon to execute Web-Viewer.

*If ActiveX control installation is required for the first time access, please click 'Yes'.

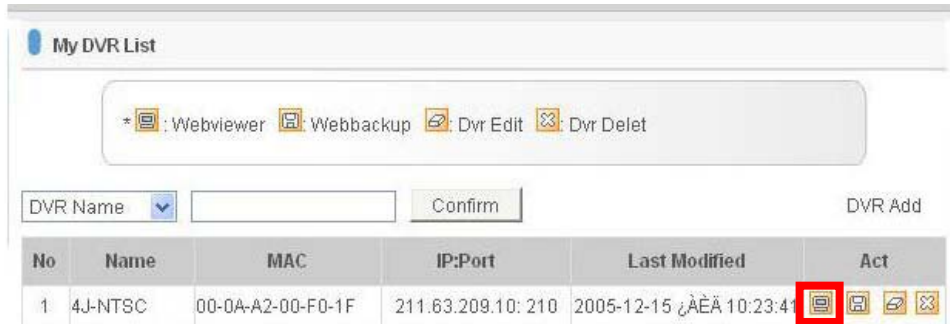

2) The following Web-Viewer will pop up. Press 'connect' button to see the Live image.

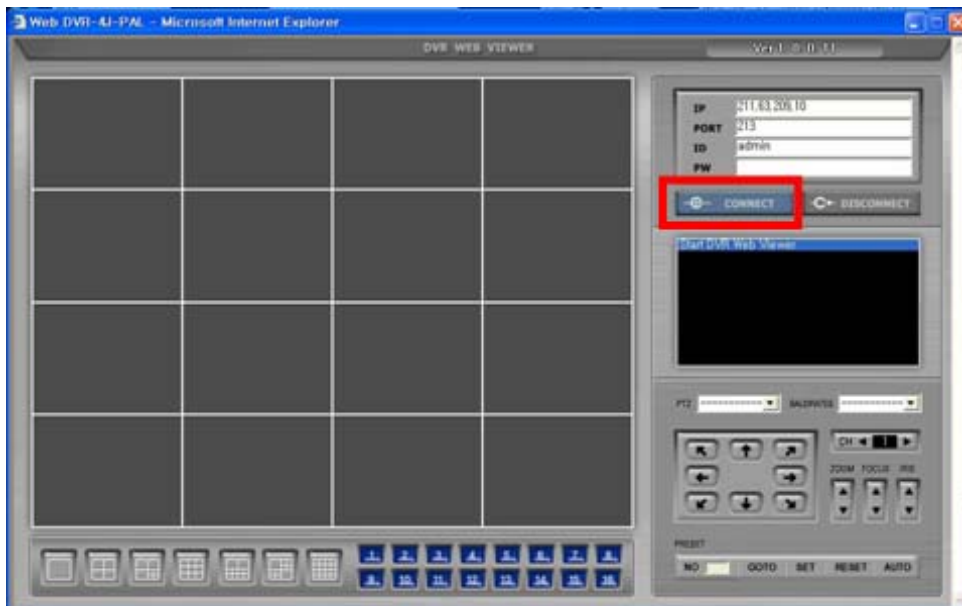

3) You can see the Live image as shown below.



7-4. Web Backup Player

- 1) To execute Web Backup Player, click web viewer icon on the right.
* *If ActiveX control installation is required for the first time access, please click 'Yes'.
- 2) The following Web-Viewer will pop up. Press 'open' button to open the backup image file.



- 3) Choose one backup data file and click 'open' button on window.

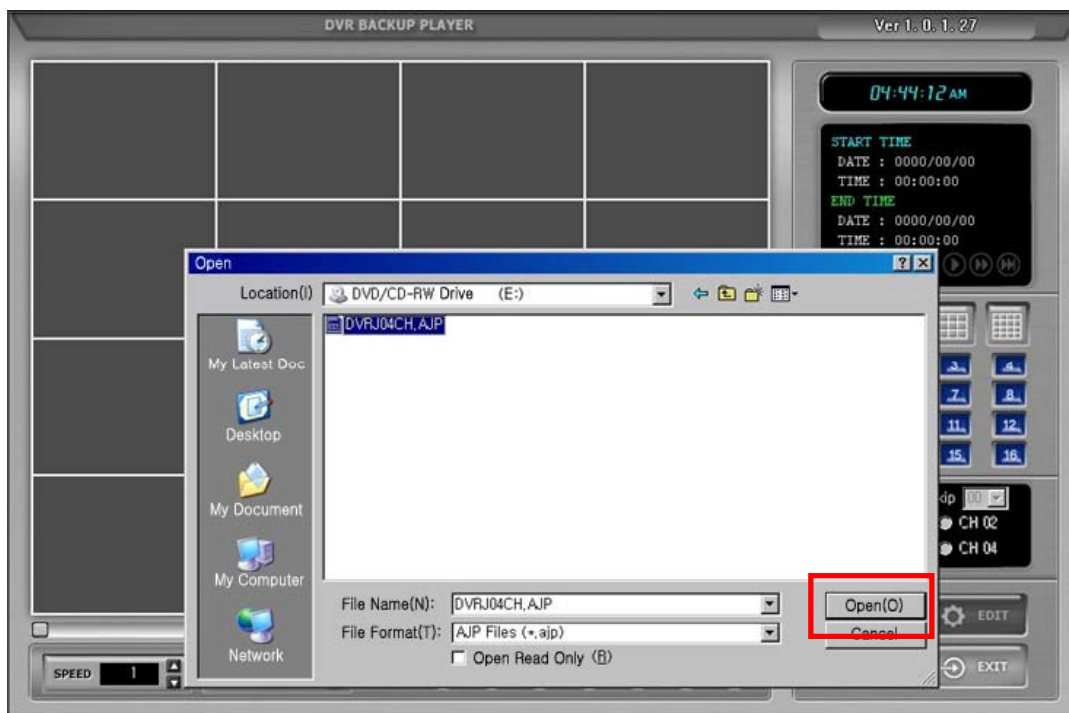

4) You can see Backup images shown as below.



7-5. Web Backup

- 1) Log on to www.j2kip.com first and then, click 'DVR Web Backup' icon on the left.

The screenshot shows the DDNS service website. At the top, it says "DDNS service DYNAMIC DOMAIN NAME SYSTEM" and has links for "[Home] [Logout] [Member Edit]". Below the header is a banner image of a person at a computer workstation with the text "DDNS Services for DVR Systems". The main content area is titled "My DVR List" and contains a list of instructions and a table for adding DVRs.

DDNS Services for DVR Systems
This website was created to provide a dynamic domain name system (DDNS) that allows DVR Systems to operate without a static IP from an Internet provider. This has been created exclusively for use with the line of products. Complete the registration process to add your DVR to the system and enjoy the many benefits of DDNS.

Welcome web

Member

- Member Register
- My Dvr List
- My DVR Register
- DVR Web Client
- DVR Web Backup**
- DVR Web Backup player

My DVR List

* Click Web-Viewer icon on the right side of ACT to operate Web-Viewer.
* You should add www.j2kip.com on Trusted Sites(Tools -> Internet Options -> Security) at first webviewer installation.
* : Webviewer : Webbackup : Dvr Edit : Dvr Delet

DVR Name DVR Add

No	Name	MAC	IP:Port	Last Modified	Act

- 2) To execute BACKUP, input IP Address & Port and click 'Connect Test' button.

The screenshot shows the "Web Network Backup" configuration window, version 1.0.0.14. It is divided into three main sections: Backup Information, DVR Server Information, and Backup Status.

Backup Information

- IP Address: 61.100.129.18
- Network Port: 50001
- User ID: admin
- User Password:
- Save File Path: C:\Documents and Settings\
- Start Backup Time: 0000/00/00 00:00:00
- End Backup Time: 0000/00/00 00:00:00

DVR Server Information

- Recorded Start Time:
- Recorded End Time:

Backup Status

- Message:
- Receive Rates:
- Backup Rates:
- Receive bps:
- Save Size:

3) After Connect Test is done, you can see 'Success Connect Test!' message. Then, click 'lock' button and click 'Set Backup Time' button.

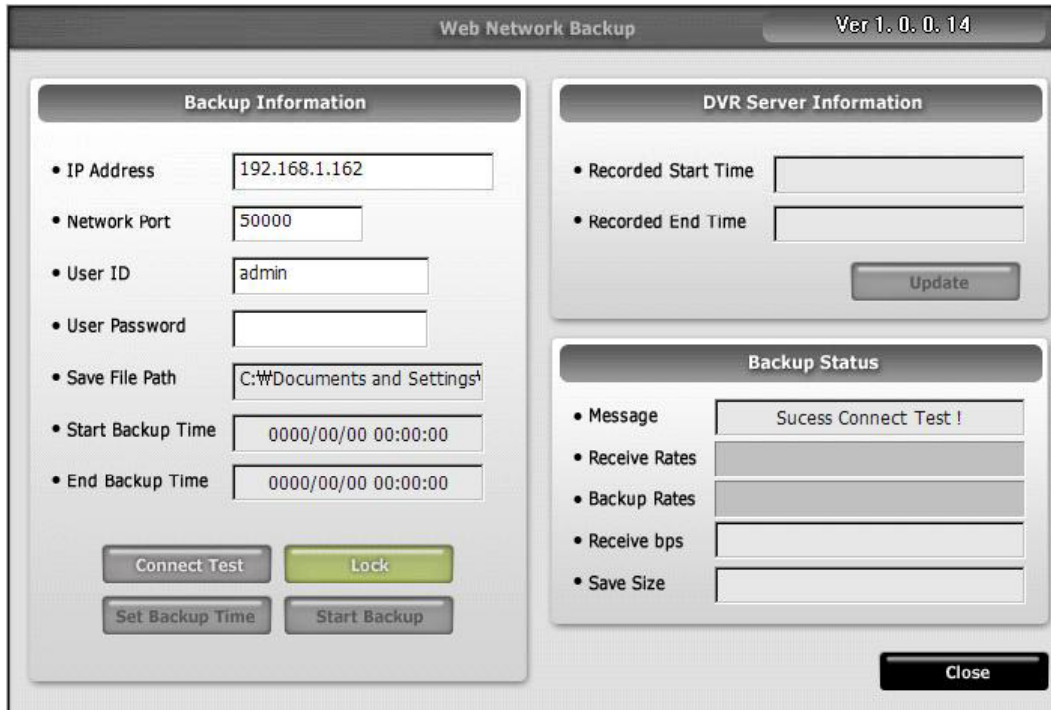

4) Now you set 'Start Time', 'End Time', 'Save File Path', 'File Size' and click 'Apply'.

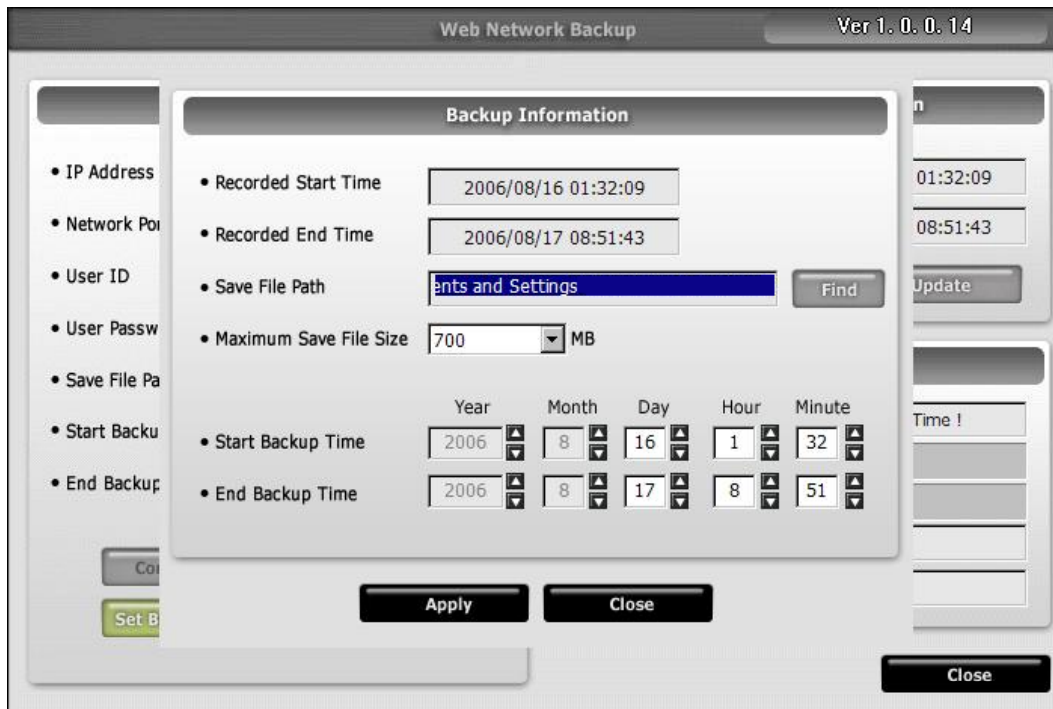

- 5) After finishing time setting, click 'Start Backup' to start backup. Then, you can see the backup file on the path that you chose.

The screenshot displays the 'Web Network Backup' interface, version 1.0.0.14. It is divided into three main sections:

- Backup Information:** Contains input fields for IP Address (192.168.1.162), Network Port (50000), User ID (admin), User Password, Save File Path (C:\Documents and Settings\), Start Backup Time (2006/08/16 01:32:09), and End Backup Time (2006/08/17 08:51:43). Below these fields are buttons for 'Connect Test', 'Unlock', 'Set Backup Time', and 'Start Backup'.
- DVR Server Information:** Shows 'Recorded Start Time' (2006/08/16 01:32:09) and 'Recorded End Time' (2006/08/17 08:51:43) with an 'Update' button.
- Backup Status:** Displays a 'Message' (Update Record Time!), 'Receive Rates', 'Backup Rates', 'Receive bps', and 'Save Size' fields.

A 'Close' button is located at the bottom right of the interface.

CHAP. 8 Specifications

- MJPEG Compression Algorithm
- Real time live display in all channels
- Triplex (Playback/Recording/Ethernet)
- Web monitoring and download through network
- Easy control by Mouse
- USB host for data backup.
- Easy PTZ Camera (MOUSE)
- Password protection
- Web control

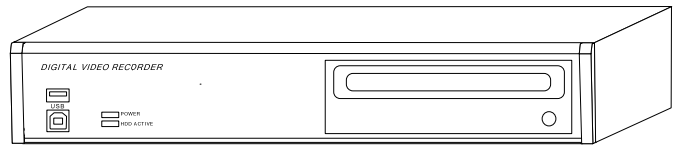

Multiplex function		Triplex (Playback/Recording/Ethernet)	
Storage	Internal	HDD	High capacity HDD support
Capacity		CD-RW	For Backup
Video	Inputs	Composite	4Ch
	Outputs	Composite	2Ch (Monitor / SPOT)
		VGA	1Ch VGA (Optional)
	Compression		MJPEG
	Compression Rate		LOWEST
			LOW
			NORMAL
			HIGH
			HIGHEST
	Live Display Speed		Real Time Live Display
Recording Mode		Time, Motion, Schedule, Alarm	
Search		Event Search, Date/time Search, Percent Search	
Recording Speed (NTSC/PAL)		Max. 120IPS(NTSC) 100IPS(PAL)	
Recording Resolution (NTSC/PAL)		Half D1 (704x240/704x288), CIF (352x240/352x288)	
Switching Interval		1~99 Sec selectable	
Live Division Screen		1 / 4 Split	
		Digital Zoom, PIP in live mode	
Alarm	Inputs		4 Alarm (NO/NC Selectable)
	Outputs		1 (NO/NC)
	Post Alarm		Alarm output duration : 1 ~ 99 Sec selectable
Network		Ethernet (TCP/IP), Web viewer included	
Backup		USB / CD-RW Back up, Download via IP Network	
PTZ Control		RS-485, MOUSE(PAN/TILT/ZOOM)	
Firmware upgrade		USB Port for firmware upgrade, CD-R	
Serial I/F		RS-485	For PTZ Camera Control
		RS-232C	For operation using keyboard of PC
Power Requirements			
Weight			
Dimensions (WXHxD)mm			
Packing			

Design and specifications are subjected to changes without notice.

MEMO :

MEMO :

MEMO :

MEMO :



4Ch Real time/Triplex/Mux