



DIGITAL VIDEO RECORDER USER GUIDE

4/8/16CHANNEL

VER AHD1K-1.0(A11)

- 
- Thank you for purchasing this Digital Video Recorder.
 - Before using the Digital Video Recorder, please ensure that you read and understand the User Guide.
 - Please store the User Guide at an easily accessible location.
 - Before connecting and installing any third party cameras, monitors, alarms and computers, please refer to the appropriate instruction manual for proper operation.

SAFETY PRECAUTIONS



CAUTION:
TO REDUCE THE RISK OF ELECTRIC SHOCK, DO NOT REMOVE COVER (OR BACK).
NO USER SERVICEABLE PARTS INSIDE. REFER SERVICING TO QUALIFIED
SERVICE PERSONNEL.

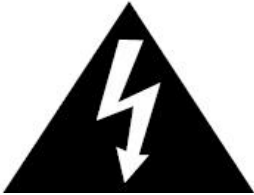

The lightning flash with arrowhead symbol, within an equilateral triangle, is intended to alert the user to the presence of un insulated “dangerous voltage” within the product’s enclosure that may be of sufficient magnitude to constitute a risk of electric shock to persons.



The exclamation point within an equilateral triangle is intended to alert the user to the presence of important operating and maintenance (servicing) instructions in the literature accompanying the appliance.

WARNING:
TO PREVENT FIRE OR ELECTRIC SHOCK HAZARD,
DO NOT EXPOSE THIS APPLIANCE TO RAIN OR MOISTURE.

Contents

Disclaimer	5
Warning	5
Caution	6
Preventing Malfunction	7
Regulatory	7
Package Contents	8
I. Controls	9
1. Front Panel.....	9
2. Rear Panel Connectors	10
3. Remote Controller	11
4. Mouse Control	12
4. Virtual Keypad for Mouse Control.....	12
II. INSTALLATION & CONNECTIONS	13
1. Camera, Monitor, Audio, Alarm sensor and Power cord	13
2. PC system requirement for Network connection.....	14
III. QUICK START PAGE	15
IV. LIVE VIEWING	17
1. Display Overview	17
2. Multi-screen Display and Sequencing	19
2.1. Screen Display.....	19
2.2. Multi-screen Display and Switch Sequencing Display.....	19
3. Quick button for multi screen Display.	20
3.1. Quick multi split mode change	20
3.2. Repositioning	20
4. Zooming	21
V. OPERATION	22
1. LOG IN/OUT.	22
2. NAVIGATION THE MENU	23
VI. SETUP	24
1. DISPLAY	24
1.1. GENERAL.....	24
1.2. SWITCH Setup (Monitor Configure)	25
1.3. EVENT	26
2. CAMERA.....	27

2.1. Video Adjustment	27
2.2. Motion Detection	28
2.3. Privacy Mask	29
2.4. PTZ Setup	30
2.5. Camera Title	31
3. RECORD	32
3.1. Record General	32
3.2. Resolution & Recording speed Setting	33
3.3. Continues /Normal Recording	34
3.4. Event Recording.....	34
3.5. Continues + Event (Motion/Alarm) Recording	37
4. SCHEDULE	37
4.1. CHART Setup.....	38
4.2. Holiday Setup	39
5. DISK.....	40
5.1. DISK Manager	40
5.2. Recording DISK.....	42
5.3. SMART STATUS	43
6. NETWORK	44
6.1. ETHERNET	44
6.2. GENERAL.....	45
6.3. EMAIL	49
6.4. SMTP	50
6.5. DDNS (Dynamic DNS).....	51
6.6 Router & Port Forwarding	53
7. DEVICE	55
7.1. GENERAL.....	55
7.2. ALARM	56
7.3. PTZ EVENT	58
8. SYSTEM.....	59
8.1. GENERAL.....	59
8.2. TIME.....	60
8.3. ACCOUNT	61
8.4. UPDATE.....	63
8.5 ADVANCED	64
8.6. INFO.....	65
VII. PAN/TILT ZOOM CONTROL.....	66

1. P.T.Z. Menu	66
2. Preset & Tour	68
3. Custom Functions	70
4.Auto Pan / Auto Tilt / Power	70
1. Playback	71
2. Time Search	72
2.1 Multi Channel Playback.....	72
2.2 Preview Search (Single Channel Playback)	73
2.3 Event Record Search	74
2.4 Event Source Search	75
2.5 Motion Area Search (Single Channel Playback)	77
3.Go to Search	78
4.Log List Search.....	78
IX.BACKUP	80
1. Manual Back up	80
1.1. External USB HDD / Memory Stick.....	80
1.2. External CD/DVD –RW Backup	81
1.3 Back up Range Setup	82
2. Auto Back up(FTP)	83
X.SPECIFICATION	84

Disclaimer

- The information in this manual is believed to be accurate and reliable as of the date of publication. The information contained herein is subject to change without notice. Revisions or New editions to this publication may be issued to incorporate such change
- We makes no warranties for damages resulting from corrupted or lost data due to a mistaken operation or malfunction of the Digital Video Recorder, the software, the hard drives, personal computers, peripheral devices, or unapproved/unsupported devices.

Warning

- Do not cover the ventilation opening or slots on the outer casing. To prevent the appliance from overheating, provide at least two inches of air space around the vent and the slots.
- Do not drop metallic parts through slots. This could permanently damage the Digital Video Recorder. Immediately turn the DVR's power off or unplug the power cord from the power outlet. Contact a qualified service personnel authorized by your equipment distributor
- Do not attempt to disassemble or alter any part of the equipment that is not expressly described in this guide. Disassembly or alteration may result in high voltage electrical shock. Qualified service personnel authorized by your equipment distributor should conduct internal inspections, alterations and repairs.
- Stop operating the equipment immediately if it emits smoke or noxious fumes. Failure to do so may result in fire or electrical shock. Immediately turn the DVR's power off, remove the power cable from the power outlet. Confirm that smoke and fume emissions have ceased. Please consult your DVR distributor.
- Stop operating the equipment if a heavy object is dropped or the casing is damaged. Do not strike or shake. Failure to do so may result in fire or electrical shock. Immediately turn the DVR's power off or unplug the power cord from the power outlet. Please consult your DVR distributor.
- Do not allow the equipment come into contact with, or become immersed in, water or other liquids. Do not allow liquids to enter the interior. The DVR has not been waterproofed. If the exterior comes into contact with liquids or salt air, wipe it dry with a soft, absorbent cloth. In the event that the water or other foreign substances enter the interior, immediately turn the DVR's Power off or unplug the power cord from the power outlet. Continued use of the equipment may result in fire or electrical shock. Please consult your DVR distributor.
- Do not use substances containing alcohol, benzene, thinners or other flammable substances to clean or maintain the equipment. The use of these substances may lead to fire. Use a

dry cloth on a regular periodic basis and wipe away the dust and dirt that collects on the device. In dusty, humid or greasy environments, the dust that collects around the ventilation or the slots on the outer casing over long periods of time may become saturated with humidity and short-circuit, leading to fire.

- Do not cut, damage, alter or place heavy items on the power cord. Any of these actions may cause an electrical short circuit, which may lead to fire or electrical shock.
- Do not handle the device or power cord if your hands are wet. Handling it with wet hands may lead to electrical shock. When unplugging the cord, ensure that you hold the solid portion of the plug. Pulling on the flexible portion of the cord may damage or expose the wire and insulation, creating the potential for fires or electrical shocks.
- Use only the recommended power accessories. Use of power sources not expressly recommended for this equipment may lead to overheating, distortion of the equipment, fire, electrical shock or other hazards.
- Do not place the batteries near a heat source or expose them to direct flame or heat. Neither should you immerse them in water. Such exposure may damage the batteries and lead to the leakage of corrosive liquids, fire, electrical shock, explosion or serious injury.
- Do not attempt to disassemble, alter or apply heat to the batteries. There is serious risk of injury due to an explosion. Immediately flush with water any area of the body, including the eyes and mouth, or clothing that comes into contact with the inner contents of the battery. If the eyes or mouth contact these substances, immediately flush with water and seek medical assistance from a medical professional.
- Avoid dropping or subjecting the batteries to severe impacts that could damage the casings. It could lead to leakage and injury.
- Do not short-circuit the battery terminals with metallic objects, such as key holders. It could lead to overheating, burns and other injuries.
- The supplied power supply and power cord are designed for exclusive use with the Digital Video Recorder. Do not use it with other products or batteries. There is a risk of fire and other hazards.

Caution

- Do not operate the appliance beyond its specified temperature, humidity or power source ratings. Do not use the appliance in an extreme environment where there is high temperature or high humidity. Use the device at temperatures within +0°C - +40°C (32°F - 104°F) and humidity below 90 %. The normal operating power source for this device is DC12V 50/60Hz.

Preventing Malfunction

- Avoid Strong Magnetic Fields. Never place the DVR in close Proximity to electric motors or other equipment generating strong electromagnetic fields. Exposures to strong magnetic fields may cause malfunctions or corrupt image data.
- Avoid Condensation Related Problems. Moving the equipment rapidly between hot and cold temperatures may cause condensation (water droplets) to form on its external and internal surfaces. You can avoid this by placing the equipment in an airtight, resalable plastic bag and letting it adjust to temperature changes slowly before removing it from the bag.
- If Condensation forms inside the Digital Video Recorder. Stop using the equipment immediately if you detect condensation. Continued use may damage the equipment. Remove the power cord from the power outlet and wait until the moisture evaporates completely before resuming use.

Regulatory

FCC Compliance : This equipment has been tested and found to comply with the limits for a Class A digital device, pursuant to part 15 of the FCC Rules. These limits are designed to provide reasonable protection against harmful interference when the equipment is operated in a commercial environment. This equipment generates, uses, and can radiate radio frequency energy and, if not installed and used in accordance with the instruction manual, may cause harmful interference to radio communications. Operation of this equipment in a residential area is likely to cause harmful interference in which case the user will be required to correct the interference at his own expense.



NOTE: THE MANUFACTURER IS NOT RESPONSIBLE FOR ANY RADIO OR TV INTERFERENCE CAUSED BY UNAUTHORIZED MODIFICATIONS TO THIS EQUIPMENT. SUCH MODIFICATIONS COULD VOID THE USER'S AUTHORITY TO OPERATE THE EQUIPMENT.

CAUTION

- Risk of Explosion if Battery is replaced by an Incorrect Type. Dispose of Used Batteries according to the Instructions.
- The socket-outlet shall be installed near the equipment and shall be easily accessible

Package Contents

Please check the package and contents for visible damage. If any components are damaged or missing, do not attempt to use the unit, contact the supplier immediately. If the unit must be returned, it must be shipped in the original packing box.

CONTENTS	QUANTITY	REMARK
DIGITAL VIDEO RECORDER	1 UNIT	
USER MANUAL & CLIENT SOFTWARE CD	1	
REMOTE CONTROLLER	1	
BATTERY (COIN-CR2025)	1	
AC ADAPTER	1	12V2A
MOUSE	1	

I. Controls

1. Front Panel

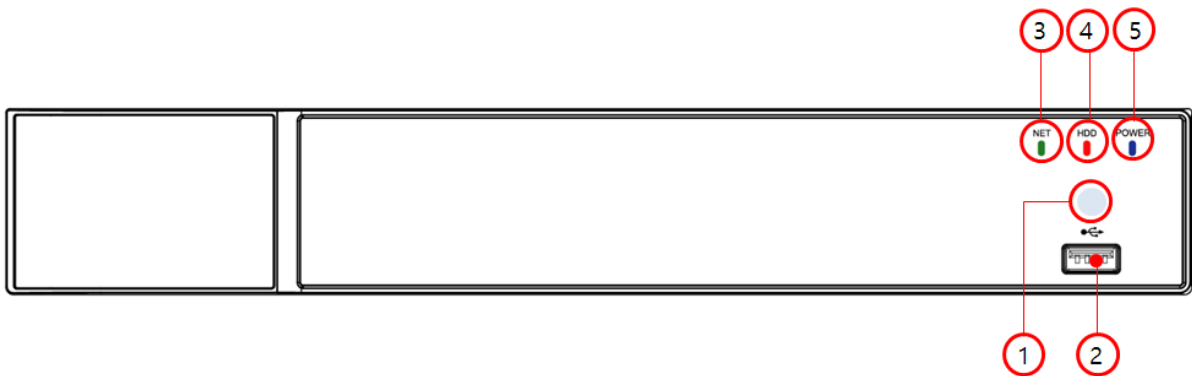

- 1) USB port : USB port allows light backups of video files to devices.
- 2) Remote control signal receiver : IR sensor to receive control signal from remote controller. Do not block the receiver port on the unit and it may be a reason for improper controlling.
- 3) LED PWR : PWR will be red when the system on.
- 4) LED HDD : HDD will be blinking as red during recording.
- 5) NET : NET will be red during connecting by remote clients.

2. Rear Panel Connectors

<4ch>

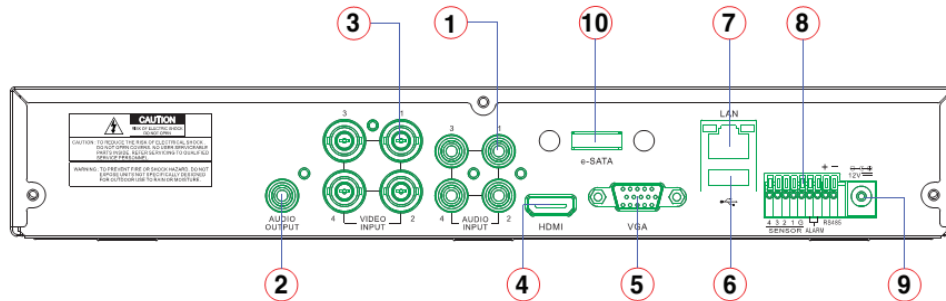

<8ch>

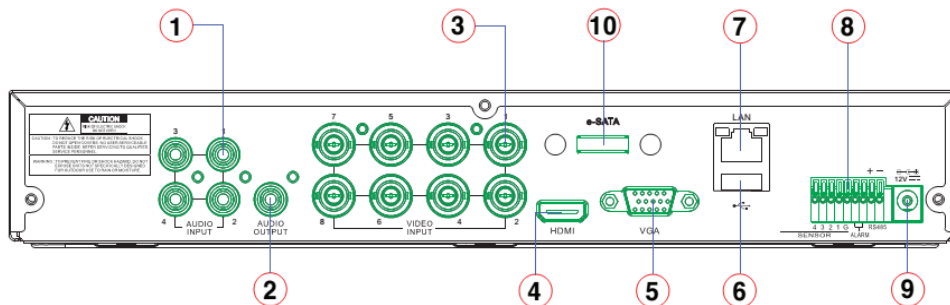

<16ch>

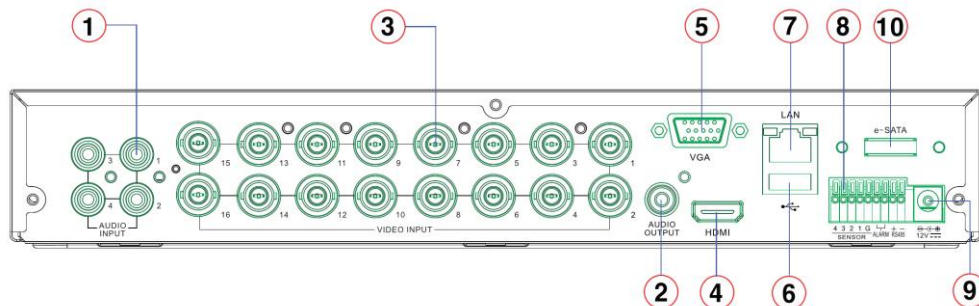

- 1) AUDIO IN : RCA Input (1~4 ch)
- 2) AUDIO OUT : RCA Output 1CH
- 3) VIDEO IN : BNC Input (Camera 1~4, 1~8, 1~16)
- 4) HDMI : HDMI monitor out
- 5) VGA : VGA monitor out
- 6) USB : USB Memory or Mouse
- 7) LAN : RJ-45 Ethernet Port
- 8) SENSOR IN : Alarm input (S1~S4) / RELAY : Alarm relay out (R1, R2)
RS-485 : Control of PTZ camera or Key board (+, -)
- 9) POWER : DC power Jack
- 10) e-SATA : e-SATA compatible devices

3. Remote Controller



4. Mouse Control

This DVR can be controlled by mouse.

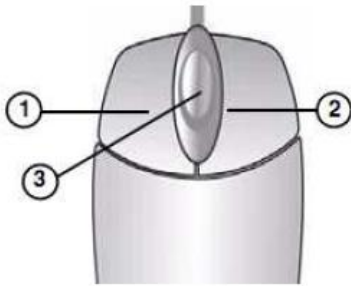

1) **Left-Button** -Double Click on any channel to enlarge to full screen while in a split-screen display mode. double click again to return.

Select the menu option while navigating through various menu options.

2) **Right Button**- Right click anywhere on the screen to open main menu. Double click to return.

3) **Scroll Wheel**: move the scroll wheel up or down to increase/decrease the value of the selected menu option.

4. Virtual Keypad for Mouse Control

This DVR provides a virtual on-screen keyboard to perform the control by mouse. Connect a mouse via USB port before use. If you click right button of your mouse in Live mode and Playback mode, you will see following virtual controller. This Virtual Keyboards operate similarly, but display different fields depending on the task being performed.



<Password >



<Playback>

II. INSTALLATION & CONNECTIONS

1. Camera, Monitor, Audio, Alarm sensor and Power cord

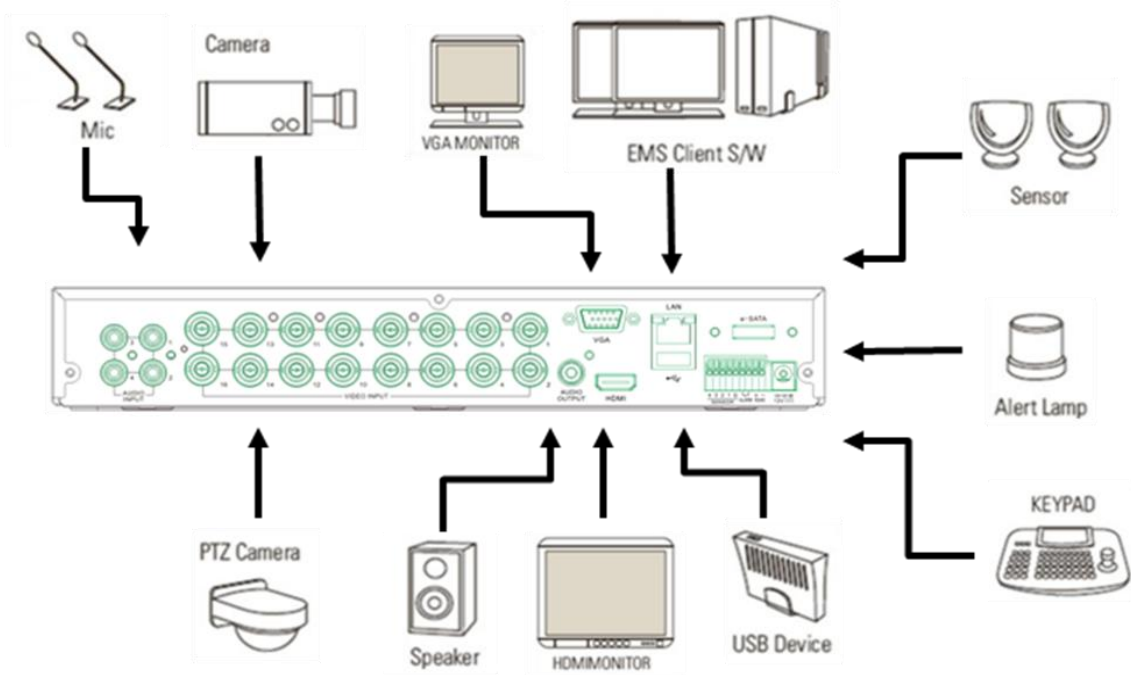

2. PC system requirement for Network connection.

	Minimum	Recommended
OS	Windows XP SP3 or higher	Windows 7
CPU	Core2 Duo	I5
RAM	2G	4G
VGA	PCI-E 256M	PCI-E 512M
DIRECTX	DX9.0 SUPPORT	DX9.0 SUPPORT
NETWORK	100M ETHERNET LAN	100M ETHERNET LAN
HDD	100G	500G

<Disclaimer>

The connection and remote viewing of the DVR may not be successful on all PC's due to the variety of PC's internet connection settings. Please contact the technical support for further assistance.

III. QUICK START PAGE



ADMIN and the default password is "000000"



The Default User ID "admin" and password to run the EMS software is "0"

Main Menu

Each Icon in the main menu works as a short cut for setting or operation of DVR.
Use remote control, front button or mouse to select the menu you want.



Time & Date Setting

When the DVR is powered on for the very first time, the time and date are set as default to January 1, 2009 Thursday 01:00:00. Before any other operation of the Digital Video Recorder, it is important to setup the time and the date. Please refer to page 63 for setting the time and the date on the DVR.



IV.LIVE VIEWING

1. Display Overview



1. Recording Mode 1 2 3

Background color of Number will be different based on the recording status.

- 1) Red - Event (Motion/Alarm) Recording
- 2) Yellow - Continues Recording
- 3) Black - No Recording.

2. Event Indicator (1) (2) (3)

(1) Indicate **Alarm** In terminal is triggered by an alarm sensor.

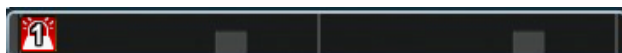

To appear Alarm window, press **[UP]** button. This button toggles between Shows or Hide the Alarm Window.

(2) Indicate **Motion** detected. To disappear, press **[CANCEL]** button.

(3) Indicate **Video Loss** during Recording. To disappear, press **[CANCEL]** button.

3. Status Bar

(1) (2) (3) (4) (5)(6)(7)



- (1) Indicate **Recording** Status. Red is Recording. Click this ICON to toggle Record Start and Stop..
- (2) Indicate **Playback** Status. Green is Playback. Click this ICON to toggle Playback Start and Stop.
- (3) Indicate **Menu**. Click this ICON to toggle popup the menu and clear.
- (4) Indicate **LOG**. Click this ICON to toggle popup the LOG menu.
After click **Menu** and **LOG**, the status bar is changed like below picture.

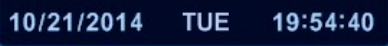

Please click  ICON to clear **Menu** and **LOG**.

- (5) Indicate Login() or Locking status
- (6) Indicate **Audio** Data is stored the selected time during playback and turn to blue color.
- (7) It shows **Number of Client**, which is connected to Network.(MAX:10)
- (8) : Displays Month, Year, Time and Date.

Change DATE FORMAT on System → Time.

(9) (10) (11) (12)



- (9) Indicate an **USB Device is connected on Front panel**. It's changed to blue color while it's doing backup. Click this ICON to toggle Back up Start and Stop.
- (10) Indicate an **USB Device is connected on Rear panel**. It's changed to blue color while it's doing backup. Click this ICON to toggle Back up Start and Stop
- (11) Show you the remaining recording time of the DVR. If remaining HDD capacity is less than 5GB, this blue "Recycling" icon will be shown up.
- (12) Show you the how long DVR records. It indicate Days and Hours.

2. Multi-screen Display and Sequencing

2.1. Screen Display.

Select any camera for Full screen display by pressing the Number button of the desired camera.

2.2. Multi-screen Display and Switch Sequencing Display.



- 1) Press **[DISPLAY]** buttons to activate the multiscreen display. It is changed the order as shown below among your choice of SPLIT MODE.
- 2) To start Auto Sequence, press **[DISPLAY]** buttons for 2 seconds to begin full screen sequencing.

Click this  ICON ,

Following virtual controller is displayed.



- 3) The sequence mode and dwell times are programmable. For detailed information about configuring those, see "**Switch Setup**". If the sequence mode is not activated, it moves to Quad mode instead of Sequencing.

4) The Split mode is programmable in General set up.

3. Quick button for multi screen Display.

3.1. Quick multi split mode change

- Press F1 button on the remote controller + <Number>

For example, press F1 button then number 8.

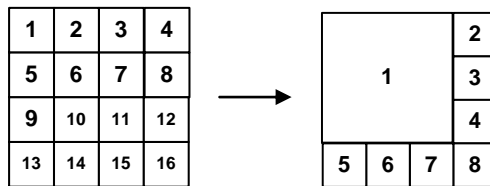

The eight channel view mode will be displayed.

<Note> 6,4,8,10,13 split mode must be checked on <Split mode> to use this function.

3.2. Repositioning

It is possible to reposition the camera from the bigger window with the one from a smaller one. It is used on 6,7,8,9,10, 13,16 split mode

① Press **F2 button** on the remote controller.  Mark will be displayed.

② Press Numeric button you wish to switching display.

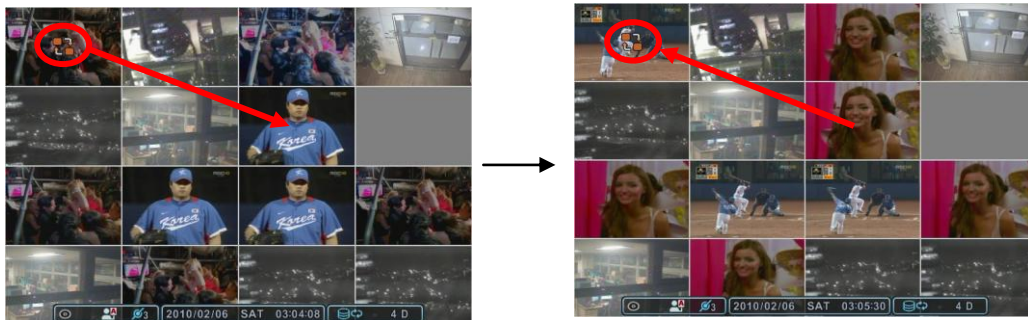

③ Press **[MENU]** button to exit here with saving changes.

Press **[Cancel]** to exit without change.

Press **[DISPLAY]** button to rearrange.

<Note> How to control on KEYPAD

1. Multi Screen (F1 function) = 16+ Display , 4+ Display button, and so on..
2. Repositioning (F2 function) = 99+ Display button
3. Auto Sequence Start = Shift & Display(at the same time)

4. Zooming

During live view mode, it is possible to zoom into a section of the screen to get a close-up view of the screen.

1. To activate the digital zoom, select the full screen display of the camera you wish to zoom.
2. Then press the **[ZOOM]** button on IR Remote controller. Zoom area box pops up, as shown below.

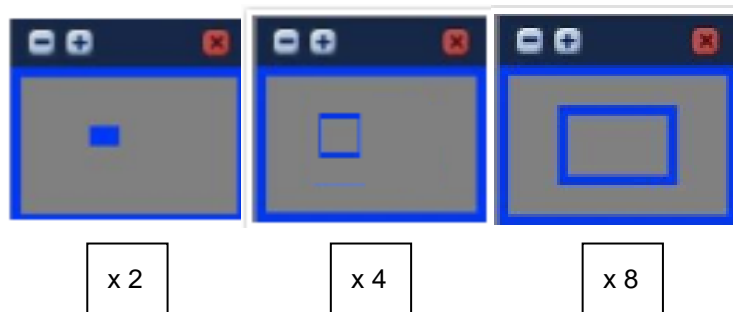

3. Move the box to the desired position using Direction [▲▼◀▶] buttons.
4. Press [+] button to enlarge the image. Press [-] button to zoom out the image.
5. Press [ESC] button to return normal mode.

<Note>

- If the Zoom button is pressed while in a multiscreen display, zoom operation is not activated.

V. OPERATION

1. LOG IN/OUT.

You must log on to the DVR with valid password to operate the DVR. By default, it comes with one login account; ADMIN and the default password is “000000”.

<Note > If you are logging on for the first time, the system does not prompt you to change the default password. Therefore, it's strongly recommended to change the “PASSWORD” when you install the DVR. Refer to [System Setup].

1. Login

- 1) On remote control, press the power button.
- 2) When the DVR is powered on, it will start to scan DVR status.
- 3) Live Viewing screen will appear after initialization about 50sec. It can be delayed when you have defect HDD, it will try to fix for logical problem but it will show you warning message for physical problem.
- 4) Press Login button on front panel or click the icon with a mouse.



- 5) Login Icon  will be displayed on status bar.

2. Logout

Press Login button on front panel or click the icon with a mouse again.



2. NAVIGATION THE MENU

1. Log on the DVR at admin level or user with configure level.
* User with configure feature is limited to access [DISK and System Menu].
2. On remote control, press **[MENU]**. Using the mouse, Right click wherever on monitor, Menu will be appeared.



3. Use Direction buttons [**▲▼◀▶**] to select the desired menu. Using the mouse, click the menu. Items selected in the menu are represented in color.
4. Press **[ENTER]** button to select the menu and display Sub-Menu. Using the mouse, double click.
5. Use Left/ Right buttons [**◀▶**] to select on TAP menu. Selected items changed into **[Orange]** color.

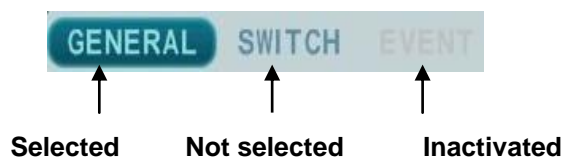

*** It is automatically saved changes when you move between TAP menus.**

6. The menus are displayed with options on the left-hand column and settings in the right hand column. A cursor (highlighted menu) can be moved using the Direction buttons [**▲▼◀▶**].
7. Press **[-, +]** button to change the value or select options. By mouse, using Wheel.
8. Press **[ENTER]** button to exit a menu with saving changes.
Press **[CANCEL]** to exit a menu without changes.

VI. SETUP

1. DISPLAY

1.1. GENERAL



1. The menus are displayed with options on the left-hand column and settings in the right hand column. A cursor (highlighted menu) can be moved using the Direction buttons [▲▼◀▶].
2. Change below options using [DEC/INC] buttons.

ITEM	ADJUSTMENT
STATUS BAR	<ul style="list-style-type: none"> • Select "Show" or "Hide" below status bar on Main Monitor.
CAMERA INFO	<ul style="list-style-type: none"> • Select On-Screen-Display information for Camera Number and Title.
BORDER LINE	<ul style="list-style-type: none"> • Select Board Line between cameras. [GRAY → WHITE → BLUE → BLACK → DARK GRAY]
BACKGROUND	<ul style="list-style-type: none"> • Select Background color on NO VIDEO status. [GRAY → WHITE → BLUE → BLACK → DARK GRAY]
OSD ALIGNMNET	<ul style="list-style-type: none"> • The main video output can be displayed on a VGA and analog monitor. Video can be displayed on both monitor simultaneously. Select On-Screen-Display coordinates on Monitor. <ul style="list-style-type: none"> - Under scan: Displays properly at CCTV Monitors - Over scan: Displays properly at VGA Monitors.
SPLIT MODE	<ul style="list-style-type: none"> • Display is changed the order as shown below among your choice of SPLIT MODE.

3. Save changes and exit the menu, press [MENU] button.
Exit the menu without making changes, press [CANCEL] button.

1.2. SWITCH Setup (Monitor Configure)



1. The menus are displayed with options on the left-hand column and settings in the right hand column. A cursor (highlighted menu) can be moved using the Direction buttons [▲▼◀▶].

2. Settings

1) Device: Each Monitor may be configured in different way.

2) Dwell Time: Select the interval that each camera or Multi screen mode is displayed in a rotation. Use [-, +] button to change : [1 second ~ 30 second]

3) Mode: Select the appropriate monitor display to making any adjustment. This Mode will be activated while it's in Switch Mode.

a. **Sequence:** Automatic Sequence.

b. **Shift:** Selected camera will be displayed after dwell time.

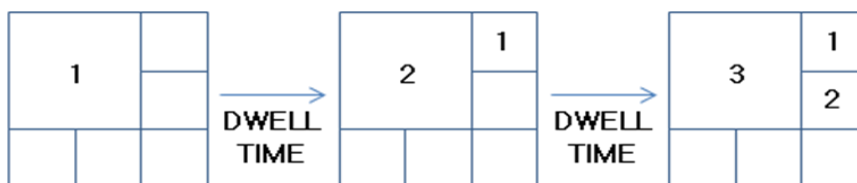

c. **Event:** To display particular camera in full screen or in multi mode when event triggered.



4) SPLIT MODE : Select desired sequence mode to switching.

5) USE CHANNEL: Select the cameras to be included or excluded from the automatic switching.

3. Save changes and exit the menu, press [MENU] button.

Exit the menu without making changes, press [CANCEL] button.

4. Press [**Display**] button for 2 seconds to start Auto Switch cameras on Main Monitor.

1.3. EVENT

This menu will be activated when you select <EVENT> Mode for Switch. Event menu will allows customization of motion, alarm and video loss.

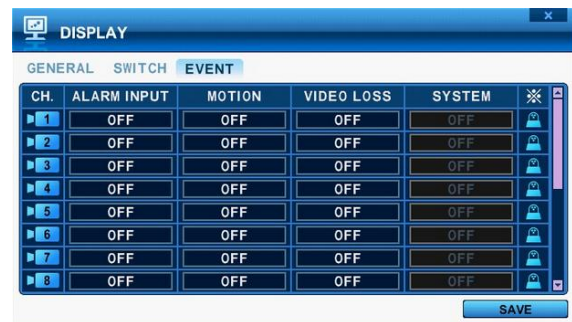
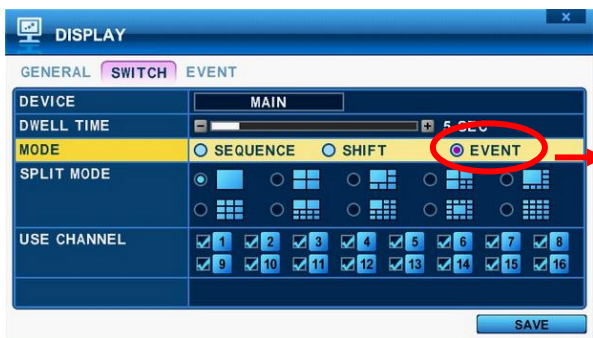

When selected event trigger such as alarm, motion or video loss, it will be displayed at the monitor that is configured for event.

2. CAMERA



1. Press Left/Right buttons [◀▶] or number button to select the desired camera
2. Camera Channel option is highlighted and the camera settings are displayed.
3. The menus are displayed with options in the left-hand column and settings in the right hand column.

2.1. Video Adjustment

To Configure Camera Settings:

Select Camera number button to configure the desired camera.

ITEM	DEFAULT	ADJUSTMENT
BRIGHTNESS	50%	<ul style="list-style-type: none"> • The brightness of each camera can be adjusted by pressing [-,+] buttons.
CONTRAST	50%	<ul style="list-style-type: none"> • The contrast of each camera can be adjusted by pressing [-,+] buttons.
COLOR	50%	<ul style="list-style-type: none"> • The color of each camera can be adjusted by pressing [-,+] buttons.
SATURATION	50%	<ul style="list-style-type: none"> • The saturation of each camera can be adjusted by pressing [-,+] buttons.

2.2. Motion Detection



To Configure Motion Area :

Select Camera number button to configure the desire camera.



1. Motion Level : The sensitivity settings are : 1: Low sensitivity~ Level 20: High sensitivity. By default , the level is set to 10.

2. Motion Grid : The area property is highlighted and motion detection can now be observed in the view window. **By default, it's OFF.**

-  : Select All. Press [ENTER] to select.
-  : Clear All. Press [ENTER] to select.
-  : Select specific. Press [ENTER] to select.

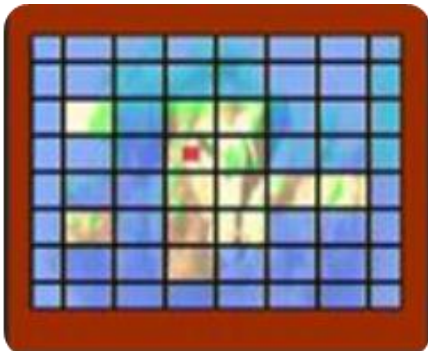

To define the motion view area cell-by-cell, do the following:

On the front panel or remote control, press any of direction buttons to highlight a cell in the motion detection area, and then press [INC/+] . This area is selected and the cells are highlighted by blue color.

Press [CANCLE] to return to left colum.

2.3. Privacy Mask



Privacy Mask allows you to mask certain areas in the surveillance video for privacy protection under related laws, policies and regulations. Areas applied with privacy masks will not be displayed. Once you've set up the Privacy Mask, by selecting positions that need video masking, the covered placement is displayed in Live View, Recording and Playback.

To Configure Privacy Mask:

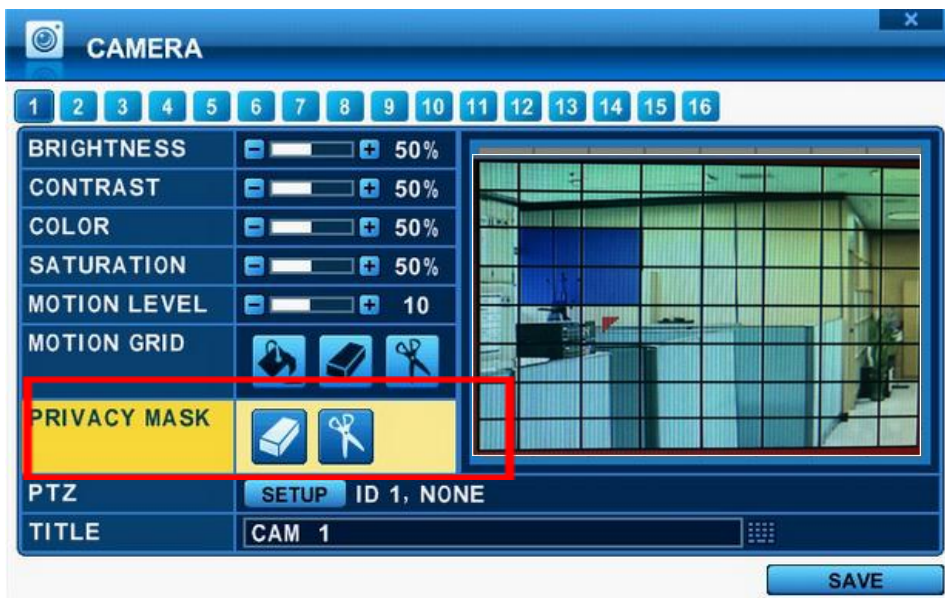
1. Select Camera number button to configure the desired camera.
2. The Privacy Mask creates a masking rectangle of a selected size then positions it on the video image. To define the Privacy Mask area, do the following;



- 1) On the front panel, or remote control, press any of directional buttons to highlight an area in the Privacy Mask area. Select Start and End Cells which you want to hide, one at a time, and then press **[ENTER]**
- 2) The area is selected and the cells are highlighted in a blue color.
- 3) The area property is highlighted and privacy mask can now be observed in the view window. **By default, it's set to OFF.**

-  : Clear All. Press [ENTER] to select.
-  : Select specific. Press [ENTER] to select.

2.4. PTZ Setup

PTZ device are connected to the RS-485 ports located on the back of the unit. Multiple PTZ cameras are connected by daisy-chaining the camera connection. This DVR allows you to address and control multiple PTZ cameras individually.

To Configure PTZ Setup :

- 1) Select Camera number button to configure the desired camera.
- 2) Press [ENTER] to configure PTZ Setup.



The menus are displayed with options on the left-hand column and settings in the right hand column.



a. Communication settings.

: Configure appropriate model and then enter the corresponding baud rate, PTZ ID(address).

b. **Tour Group:** Preset Tour allows a camera to move through a programmed sequence of PTZ preset. Please refer to **<PTZ controlling>** for more in detail.

2.5. Camera Title

Allows you to create a unique name for each camera. The camera title has the following guidelines:

- Characters: A to Z, 0 to 9. Special characters are supported by network.
- Length: up to 12 including space.

To create a camera title, using the virtual keyboard, or pressing appropriate Numeric button on IR Remote or front panel.

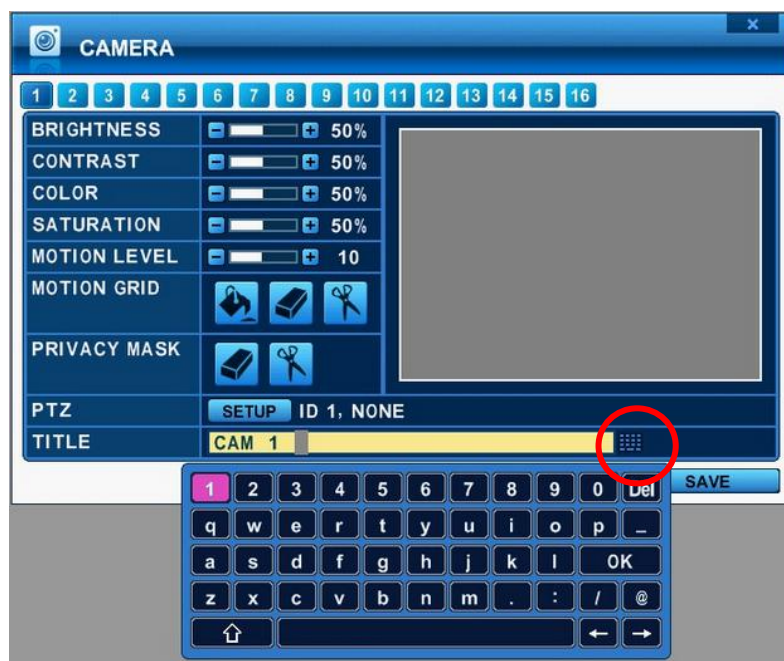

<Virtual Keyboard by Mouse>

No	1st	2nd	3rd	4th	No	1st	2nd	3rd	4th
1	A	B	C	1	7	S	T	U	7
2	D	E	F	2	8	V	W	X	8
3	G	H	I	3	9	Y	Z	@	9
4	J	K	L	4	0	.	-	_	0
5	M	N	O	5	10+	SPACE			
6	P	Q	R	6					

<on IR Remote Controller>

4. Select SAVE to save changes and press [ENTER] button to exit the menu.

Exit the menu without making changes, press [CANCEL] button

3. RECORD

3.1. Record General



1. The menus are displayed with options on the left-hand column and settings in the right hand column. A cursor (highlighted menu) can be moved using the Direction buttons [**▲▼◀▶**].
2. Change below options using [DEC/INC] buttons.
 - 1) **Schedule Use:** This enables or disables Night Zone. By default “OFF”.
 - 2) **Boot up Record:** It starts to recording without pressing [REC] button when it set “on”.
 - 3) **Disk Overwrite:** Select the record policy of the hard disk drive.
 - ON: By default, the hard disk drive will overwrite from the beginning when it becomes full.
 - OFF: It stops recording after HDD is full.
 - 5) **Auto Delete:** Allows you to configure when the DVR automatically deletes all data from HDD. It leaves the data for below duration from current time.
[NONE → 12HOURS → 1DAY~ 6DAYS → 1WEEK ~ 4WEEKS-> 30 DAYS]
 - 6) **Pre-Record:** Determines the duration of the DVR stores video recorded prior to the beginning of Event Recoding. [5SEC ~ 300 SEC]. By default 5 sec.
 - 7) **Post- Record:** Determines the duration of the DVR continues record after Event detect. [5SEC ~ 300 SEC]. By default 5 sec.
<Note> 1. Alarm/Motion Duration will be extended if there is another Alarm/motion detection while Event recording.
2. When recording, the Pre-Record and Post-Record will not be activated.
3. Save changes and exit the menu, press [MENU] button.
Exit the menu without making changes, press [CANCEL] button.

3.2. Resolution & Recording speed Setting

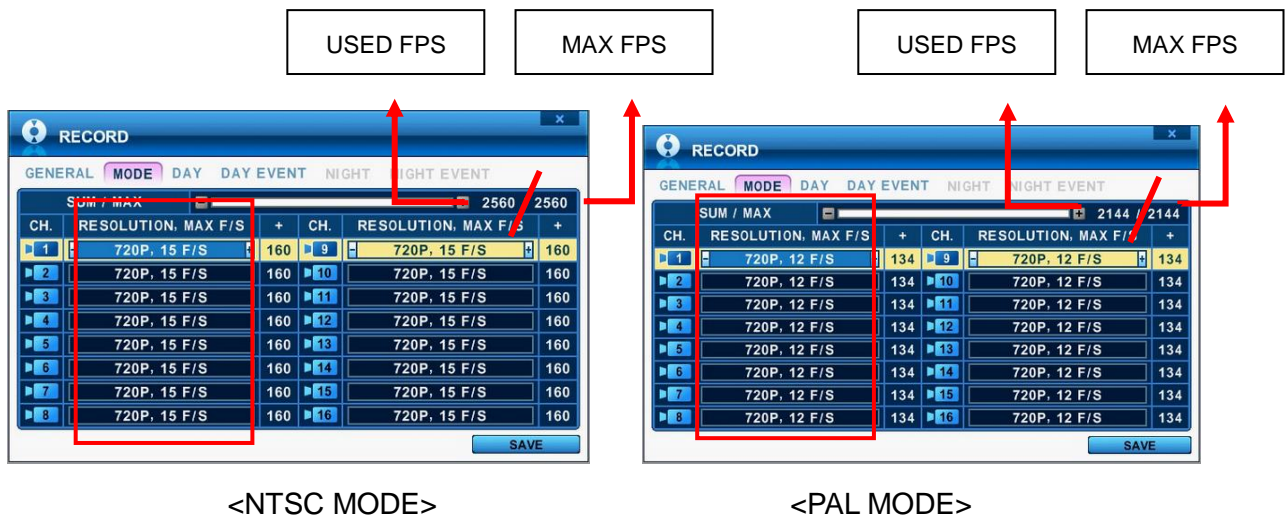

This DVR records each camera individually and then multiplexes them. You can individually set up resolution and recording speed for each channel. 720P stands for both NTSC and PAL 1280 * 720, 960H stands for NTSC 960 * 480 (PAL 960 * 576), D1 stands for NTSC 720*480(PAL 720*576), Half D1 stands for NTSC 720*240 (PAL 720*288) and CIF for 360*240(PAL 360*288)

To make them global record, select desired setting channel then press split button copy to other channel.

<Note> Total fps is displayed in SUM/MAX. MAX for each channels as below.

	4Ch	8Ch	16Ch
NTSC	640	1280	2560
PAL	536	1077	2144

If the sum of fps is over than MAX fps, below warning message will be popped up. Then automatically the last channel will be disabled.

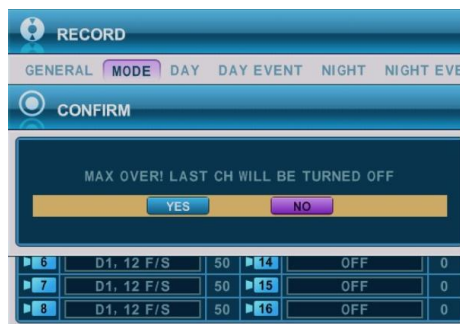

3.3. Continues /Normal Recording

The DVR comes with a certain preset settings from the factory. Therefore once the DVR is installed, immediate recording is possible after pressing the record buttons. By default, audio, alarm, motion recording are off.



The DVR records video data continuously over 24 hour period. Recording setup is for normal recording. Different settings can be configured for each camera. To copy the setting to other channel, press **[Display]** button.

ITEM	ADJUSTMENT
RES.	•Display selected resolution in MODE tab.
RATE	• Select recording speed for each camera.
QUALITY	• Specify the record picture quality for each camera. ULTRA → SUPER → HIGH → MIDDLE →LOW

3.4. Event Recording

Users may set different event recording parameters on a camera by camera basis. Set the continuous recording as [OFF] and configure the Event recording speed and Quality for each camera.

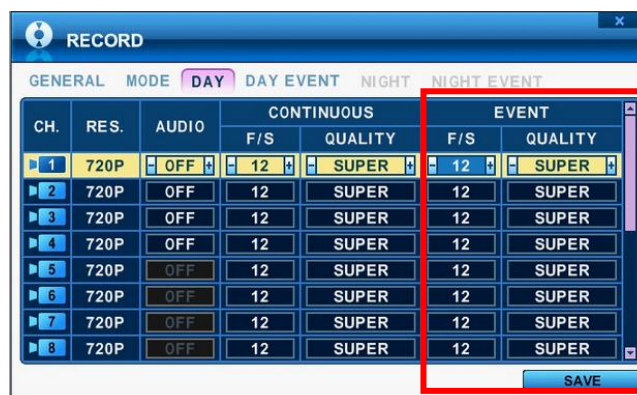

Determine whether Alarm, Motion, Video Loss for EVENT recording on **[DAY EVNET]** Tap.

1) Alarm Recording

One Alarm input can be configured to one channel. One camera channel can be assigned to multiple alarm inputs.

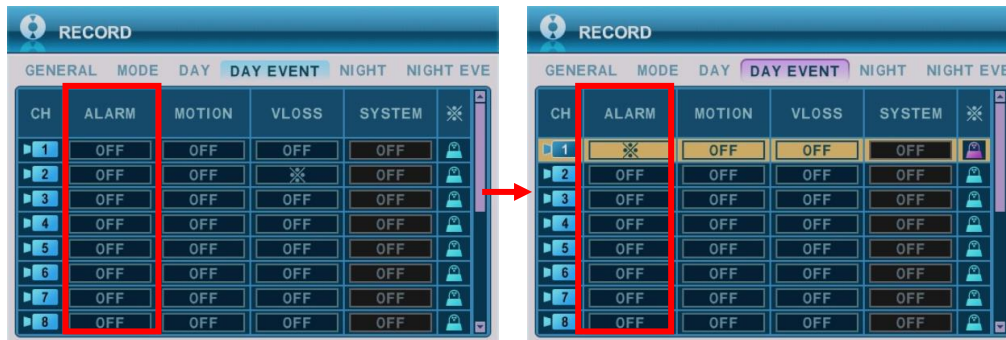

- Press [-, +] button to change the value or select options. By mouse, using Wheel.
- [⌘] indicate multiple alarm sources are selected.
- Please refer to [Device/Alarm] for Alarm inputs and outputs.

2) Motion Recording

One Motion detection can be configured to one channel. One camera channel can be assigned to multiple motion detection.

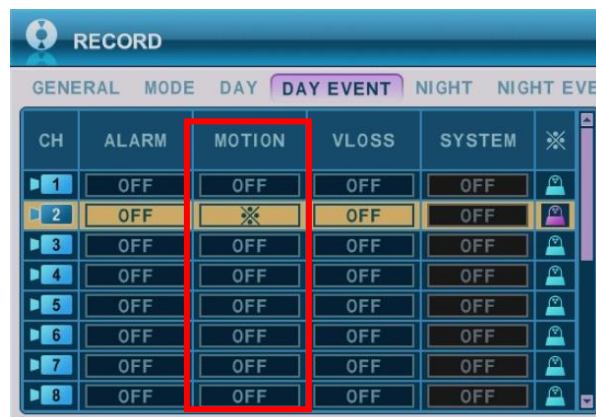

- Press [-, +] button to change the value or select options. By mouse, using Wheel.
- [⌘] indicate multiple alarm sources are selected.
- Please refer to [CAMERA] menu for Motion setup.

<Note> There may be cases when the recorder's built-in motion detection function does not operate properly due to the condition of the input video signal or other factors.

3) Multi Event Recording.

- a. **Video Loss** : When Video Loss occurs can be configured to one channel. One camera channel can be assigned to multiple Video Loss

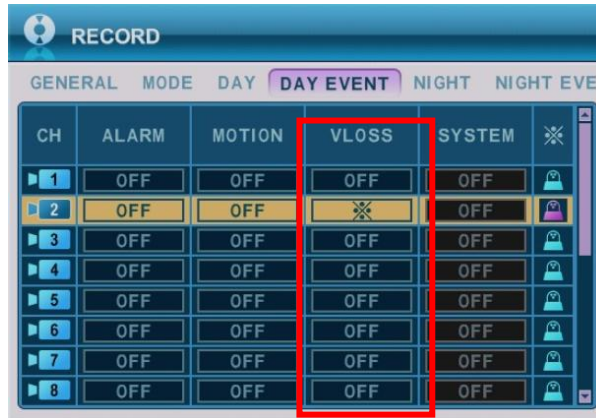

b. **Event Edit** 

- Press [enter] to edit multiple event. The menus are displayed with options on the left-hand column and settings in the right hand column. A cursor (highlighted menu) can be moved using the Direction buttons [▲▼◀▶] on IR remote.



- Change below options using [DEC/INC] buttons on IR remote or Clicking by mouse.
- System menu will not activated in this section

3.5. Continues + Event (Motion/Alarm) Recording

Both Continuous and Event recording can be set at the same time. The DVR record video data continuously over 24 hour period but when Event occurs recording speed and picture quality can be adjusted different from continues recording.

<Example>



By pressing the **REC** button, **Normal** recording starts with High picture quality at 3F/S. When **Event** is triggered on this channel, it changed to record with Super picture quality at 30 F/S. It will be back to **Normal** Recording after Event duration is end.

<Note> Please determine Event source such as Motion, Alarm, Video Loss on DAY EVENT tap.

4. SCHEDULE

When the schedule is on, users may define their own daytime, night time, as well as specified date settings. A schedule can be used to record selected cameras at different Times, changes record rates, and select whether alarms or event is enabled. By selecting Schedule USE "on" Record setup, Night Mode will be activated.

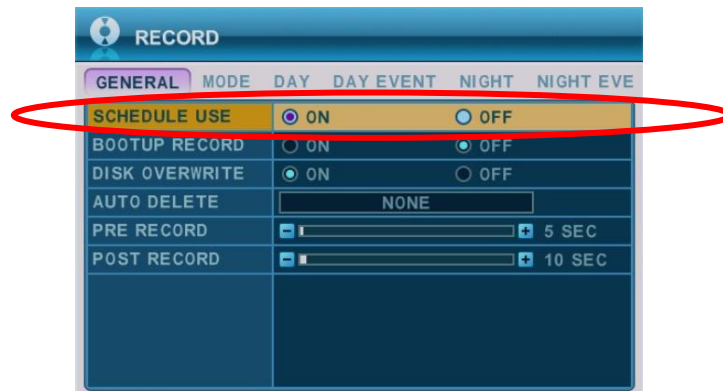

4.1. CHART Setup

The schedule chart shows a graphical representation of the defined record mode. Night mode will be set by default. However, the schedules are only displayed if a corresponding schedule has been configured in the schedule menu.

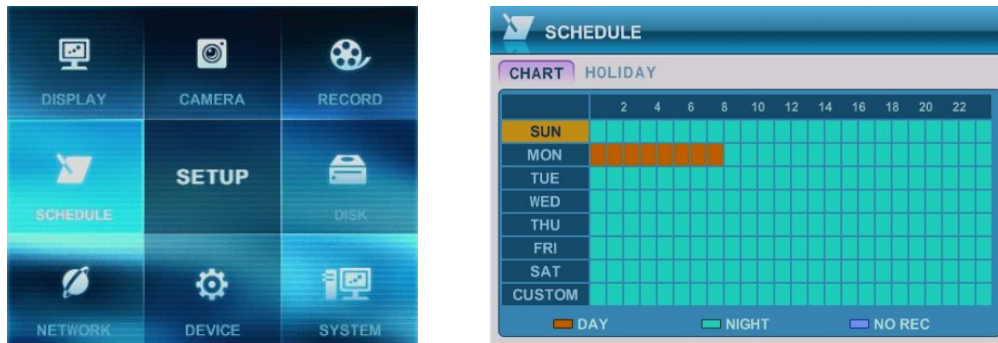

- * DAY (Yellow): It follows day setting on record.
- * Night (Green): It follows automatically night setting.
- * No Record (Blue): The video is displayed, but does not record video.

- 1) A cursor (highlighted menu) can be moved using the Direction buttons [▲▼◀▶].
- 2) Select each day to configure, press [Enter] or clicking by mouse.
- 3) Detailed menu pops up for select day, as shown below.



- a. Use [-, +] button to change the values.
 - Mode : [Night] → [Day] → [No Rec]
 - BEGIN: The time of recording start.
 - END: The time of recording end. The ending time must not be before the starting time or the same as the starting time. It must be any time over the starting time.

- b. Save changes and exit the menu, press [MENU] button.
Exit the menu without making changes, press [CANCEL] button.

4) Copying Schedule

- a. A cursor (highlighted menu) can be moved using the Direction buttons [▲▼◀▶] on Day(Sun – Sat)
- b. Press [Display] button on desired setting.



4.2. Holiday Setup

This allows you to create up to 32 holidays. If a holiday schedule occurs on the same date as a weekday schedule, the holiday schedule will override the weekday schedule.



- 1) A cursor (highlighted menu) can be moved using the Direction buttons [▲▼◀▶].
- 2) Select each day to configure, press [Enter] or clicking by mouse.
- 3) Use [-, +] button to change the values.
 - Mode : [OFF] → [Day] → [Night] → [No Rec] → [Sun~Sat] → [Custom]
 - Date: The date of Holiday start. .
 - Days: The time of holiday duration [1 to 15 days]

5. DISK

5.1. DISK Manager

Disk Manager is used to format hard disk and to assign the HDD usages such as back up or mirroring.



1. Select

- 1) The menus are displayed with options all installed HDD or ODD list.
- 1) Press up/down [**▲▼**] buttons to highlight Hard Disk or ODD, then press [**-, +**] button to select. Using the mouse, click the HDD option.
- 2) Device & Size: This information lists the installed drives and their respective capacities, which is not used currently.
- 3) Status:
 - a. CD/DVD : CD or DVD is installed for back up usages.
 - b. Unknown: New installed Disk.
 - c. Empty: Formatted but not used in current DVR.
 - d. Recording Data: HDD stored Recording data but not used in current DVR.
 - e. Back up Data : HDD stored Back up data.
 - f. Other data: Neither Back up nor Recording Data, including AVI file.
 - e. Damaged

<Note>: Disconnected Disk will be disappearing from Disk Menu.

2. Action :

3. None: By default.

4. **Assign to Record**: Initialize the selected HDD. It formats the drive and all data on the drive is erased. Selected HDD will be move to [Recording Disk] after formatting.

5. **Initialize for Back Up**:

Selected device, such as Media or External HDD, is formatted for backup use. Here's the guide for backing up data to various devices.

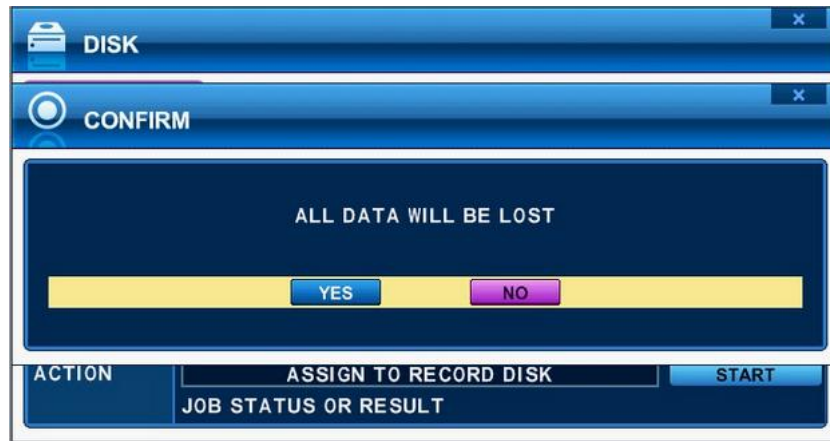

Once you press the start button, this pop-up window is displayed to ask you to confirm the initialising for back up: YES or NO.

6. Link Record Disk

: This function is used for add [used HDD] from same model without formatting.

< note : There are limitations for using this function >

A.DVR should be empty (NO HDD). If RECORDING DISKs are existed, it's not working.

B.The used HDD should be from same series. It's not working with different series.

C.There should be no time duplication in HDD.

Device	HDD	
	SATA	USB
Media can be formatted	O	X
Device can be formatted on a PC using FAT 32, NTFS File system.	O	O
Media must be formatted on DVR before backing up or exporting data to the device.	△	△

<Note1> USB flash memory is working without format.

<Note2> if a FAT32 /NTFS formatted external USB device is installed, <Assign to Stream> feature is disable. It's limited to back up only.

3. Press [+] button to start selected action

4. Save changes and exit the menu, press [MENU] button.

Exit the menu without making changes, press [CANCEL] button.

5.2. Recording DISK

This information lists the installed drives how the DVR record video and their respective capacities, which is currently used for recording.

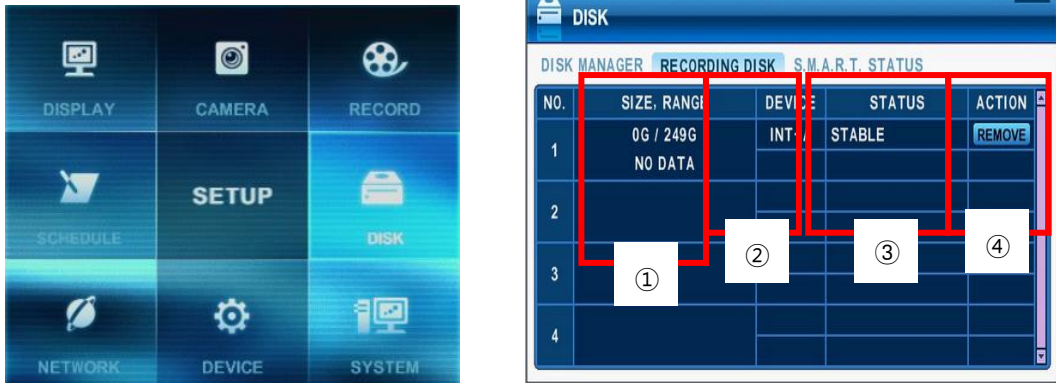

1. Size, Range

: This displays current recorded data size, HDD size and indicated stored data range and where the writing progress is running

2. Device

It displays logical Master and Slave device in mirroring. Upper device is Master and the other is used for slave. If slave HDD is reached to 100% synchronize, Master HDD can be removed as well.

3. Status

- 1) Stable : The HDD is in stable status.
- 2) Recover: To force all pending buffered disk writes to the slave disk.

4. Action : Remove HDD.

The "Are you sure?" dialog box opens.



Press up/down [] buttons to YES or NO, then press [-, +] button to select.

5.3. SMART STATUS



NO	ID	BAD	TEMP	TIME	STATUS
1	INT-A	2	38 °C	277 D	PAST PREFAIL
2					
3					
4					
5					
6					
7					
8					

It displays HDD information such as Bad sector, temperature, HDD running time. S.M.A.R.T information has slight different between different HDD manufactures.

It recommended exchanging the HDD when the HDD status is in <PRE-FAIL>

***NOTE : Please refer to STATUS explanation**

Status	Explanation
GOOD	GOOD
PRE-FAIL	Alerts that may have problem
PAST PRE-FAIL	“PRE-FAIL” was occurred before
FAIL	Find problem / need to replace

6. NETWORK

The static service consists of an IP address that remains constant for the duration of the contract of the internet service, whereas the dynamic service consists of an IP address that frequently changes every time a new connection is made through the provided modem, or recurrently in a given period of time. Though most internet service providers offer both solutions, this manual will distinguish the two solutions according to the commonly available service type to configure the DVR for the networking purposes.

6.1. ETHERNET

The screenshot shows the NETWORK configuration page with the ETHERNET tab selected. The CONFIG section has the STATIC IP radio button selected. The fields are filled with the following values:

CONFIG	STATIC IP	DHCP
IP ADDRESS	192.168.10.15	
NETMASK	255.255.255.0	
GATEWAY	192.168.10.1	
PRI. DNS SERVER	192.168.0.5	
SEC. DNS SERVER	210.220.163.82	

The screenshot shows the NETWORK configuration page with the ETHERNET tab selected. The CONFIG section has the DHCP radio button selected. The fields are filled with the following values:

CONFIG	STATIC IP	DHCP
IP ADDRESS	192.168.10.15	
NETMASK	255.255.255.0	
GATEWAY	192.168.10.1	
PRI. DNS SERVER	192.168.0.5	
SEC. DNS SERVER	210.220.163.82	

1. Static IP

If the Static IP is selected, the following settings are available:

- 1) **IP Address** : Enter the static IP address
- 2) **Netmask** : Enter the IP address of subnet mask.
- 3) **Gateway**: Enter the IP address for the internet gateway server.
- 4) **PRI.DNS Server**: Verify the name of the domain name system.
- 5) **SEC.DNS Server**: Enter the IP address of the backup domain name system (DNS) server that the DVR will use to convert name to IP address. This server is used if the primary DNS server fails.

<Note> if you do not set up DNS server correctly, it will have problem with mail sending.

2. DHCP: Dynamic Host Configuration Protocol.

It is automatically set on from Local DHCP if there is Local DHCP server (i.e. The local Router) . if the DHCP is set to ON, the IP address, Gateway and subnet Mask will be assigned by DHCP server.(i.e.The local area network Router)

6.2. GENERAL

1. Access Port: Select "0001 ~ 9999"

Enter the port number that the client will use to communicate with the DVR over the internet. The default port is 7000. It is recommended to use over 1,000.

2. Bandwidth: Select the network bandwidth to limit the amount of network resources allocated to client connection..The default is unlimited: " 4 Kbps~ 8 Mbps"

3. Access Block

1) Ping Block: No response to ping. By default OFF.

2) Scan Block: No response to Auto Scan from EMS. By default OFF

4. Access Host and Host List

Access Host and Host List: Allows you to access or deny specific IP address.

To allow or deny remote access requires you to enter a range of IP addresses as an IP address and mask. Host List will be activated when you select deny or allowed.

5. Auto Port Forward: Select the Insert or remove button to automatically open or remove ports for Router communication with UPNP compliance
6. Two-Way Audio : : Support 2 way Audio between DVR and Remote Software
7. Stream Mode : Select network stream mode between Dual or Optimized
 - 1) Dual: Streaming the video/audio data with a specified quality
For slow network , select this option. And the image quality is changed.

<Note> Dual stream for Network

	Available F/S by channel
NTSC	CIF, 7 F/S
PAL	CIF, 6 F/S

- 2) Optimized: Streaming the video/audio data with a maximized throughput, it depends on recording configuration but use manufacture's own method.
It provides better network streaming rate.

Example

RECORDING SETUP		NETWORK STREAM	
720P,960H,D1,2CIF,CIF	30 (25) FPS	720P,960H,D1,2CIF,CIF	30 (25) FPS
720P,960H,D1,2CIF,CIF	1~15 (1~12) FPS	720P,960H,D1,2CIF,CIF	15 (12) FPS

8. Stream Property: It's activated when you select dual streaming.

6.3. EMAIL

This DVR allows you to specify the events that generate notification. Sends e-mail notification if an event occurs such as alarm or motion is detected and so forth.



The mail server can use either the DVR mail server or your existing e-mail settings.

The menus are displayed with options on the left-hand column and settings in the right hand column. A cursor (highlighted menu) can be moved using the Direction buttons [**▲▼◀▶**].

1. **USE** : Select the e-mail notification on or off. The default is off. Press [**-**, **+**] button to select. Using the mouse, click the option to select mail server.
 - 1) **Default**: Default it is provided by manufacture. Mail notification options and mail address settings are available.
 - 2) **SMTP** : SMTP Configuration TAP will be activated to set up your own mail settings.
2. **Send Period**: e-mail will be sent by selected intervals.
 - 1) **Event** : [Immediately, 10 Minutes, 1 hour, 1 Day]
 - 2) **Log** : [1 Day, 1 Week]
3. **Retry Count** : Select the number to try to send e-mail again when fails up.
4. **E-mail Source**: Event must be specified using notification options.
 - 1) **Event Edit**:. Notifications can be enabled for each channels for Alarm, Motion, Video Loss and System (HDD Fail, Record Fail, HDD Full and etc). Press [enter] button to select.



- 2) Log: This DVR will mail Log list at selected intervals.
- 5. Attach Picture: While you are in recording mode, picture can be attached for mail.
- 6. E-mail Address: 5 mail addresses can be configured for mail notification.

6.4. SMTP

This menu will be activated when you check <SMPT> on EMAIL.

The following settings are only needed if you are NOT using the DVR mail server.

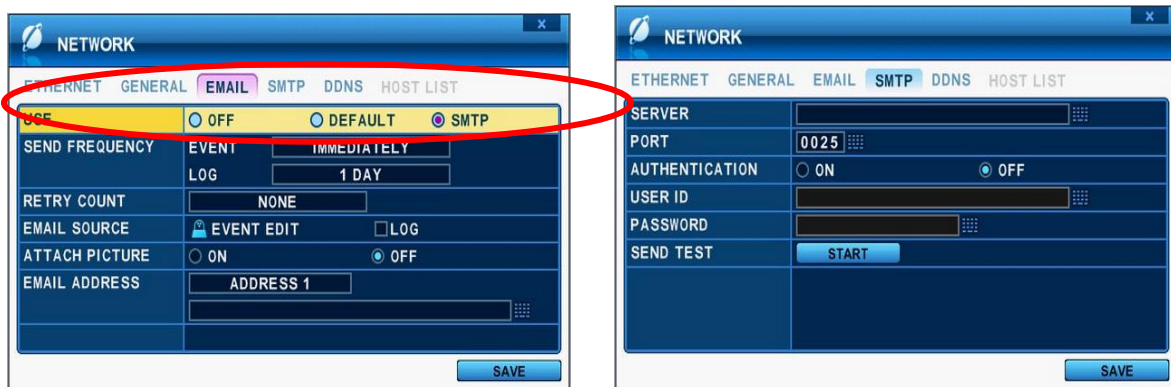

1. Server: Enter the e-mail server name or IP. To server name, using the virtual keyboard, or pressing appropriate Numeric button on IR Remote or front panel.
2. Port : Define the port that the SMTP server will communicate through. By default, it set to 25.
3. Authentication: Check this <on> if your mail server requires authentication.
4. User ID & Password: Enter the user ID/name and password for the SMTP Server. (It is recognized as a small letter, even it's displayed as a Capital Letter).
5. Sent test : Test to send e-mail.
6. Save changes and exit the menu, press [MENU] button.
Exit the menu without making changes, press [CANCEL] button.

6.5. DDNS (Dynamic DNS)

This DVR offers free dynamic DNS update. It keeps track of your changing IP address. It's easiest to use.

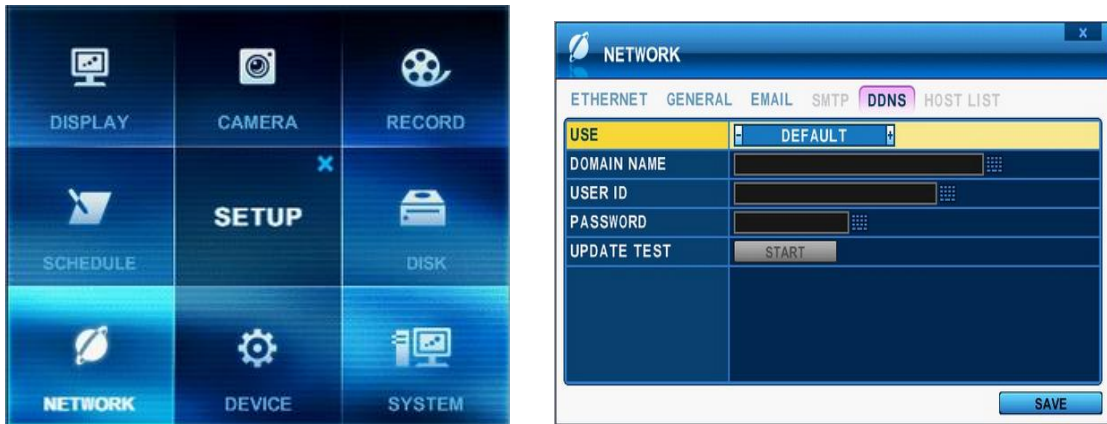

The menus are displayed with options on the left-hand column and settings in the right hand column. A cursor (highlighted menu) can be moved using the Direction buttons [▲▼◀▶].

1. USE : Select DDNS on or off. The default is off. Press [-, +] button to select. Using the mouse, click the option to select DDNS provider.

1) **Default:** Default it is provided by manufacture. We offer DDNS service for remote at <http://www.dvrhost.com>

If you are using <Default> for DDNS, you do not need to setup anything. It's not allow to you create host name. It's providing by DVR. Press [info] button on IR remote or Front panel, then check your host name.



For example, <http://G747474.dvrhost.com:7400>

2) **DYNDNS:** To use your own domain name service or “dyndns.com”

2. The following settings are only needed if you are NOT using the default.
 - 1) Domain Name: Enter the name you set for the DDNS web configuration.
 - 2) User ID: Enter your user ID.
 - 3) Password: Enter your password.
 - 4) Update Test: Click the Update Test button to confirm the connection. A success message will appear.
3. Save changes and exit the menu, press [MENU] button.
Exit the menu without making changes, press [CANCEL] button.

6.6 Router & Port Forwarding

The majority of any network will often consist of a single IP address which shares the internet access through a router. This IP address may be any external (public) static IP address or any dynamic IP address issued by the Internet Service Provider.

The purpose of a router is to enable multiple personal computers and any other devices that require internet connection to access the internet simultaneously. Most routers by default enable (open) commonly used ports so that mainstream applications such as Hypertext Transfer Protocol (HTTP, Port 80), File Transfer Protocol (FTP, Port 21), Telnet (Port 23) and Post Office Protocol 3 (POP3, Port 110) are used.

To solve the firewall problem and let visitor into the network, the user instructs the router to allow traffic to pass through on a given port. This is known as Port Forwarding, as the router forwards (directs) all internet requests on a specific port to the local machine. With port forwarding, external visitors are able to connect to the DVR while other internal devices remain protected.

Here is the example of DVR connection.

Network	Router	DVR IP Setting	PC Connect position			PC Connect position		CF
			① LAN			② WAN		
			A	B	C	B	C	
Static IP	use	STATIC	○	△	X	★	★	
		DHCP	○	▲	X	☆	★	Check the DVR IP of info and set into Router.
	x	STATIC	○	○	○	○	○	
		DHCP						N/A [Need Local DHCP Server]
DHCP	use	STATIC	○	△	X	★	★	
		DHCP	○	△	X	★	★	Check the DVR IP of info and set into Router
	x	STATIC						N/A
		DHCP				△	△	PPPOE is not supported

1) Description of Location.

- A. LAN: Connect by Local IP. If you are connection from within your network, you only need to enter the IP address of the system into the S/W (ex. 192.168.0.50)
- B. WAN: Connect by DDNS. If you are connecting from outside your network, use the DDNS to configure the S/W.(Ex. L123456.dvrhost.com).
- C. WAN: Connect by IP address. If you are connecting from outside your network and if you know your Static IP address , use the IP address to configure the S/W. (Ex. <http://124.137.23.72:6000>)

2) Description of Symbols.

- : Connected.
- x : Not able to connect
- △: There's some limitation depends on Router or Network connection
- ★ : Need to use Port Forwarding

3) Description of Color.

- Yellow - Recommended
- Grey - Non available
- White – Depends on Router or Network condition.

2. How to use DVR for DHCP

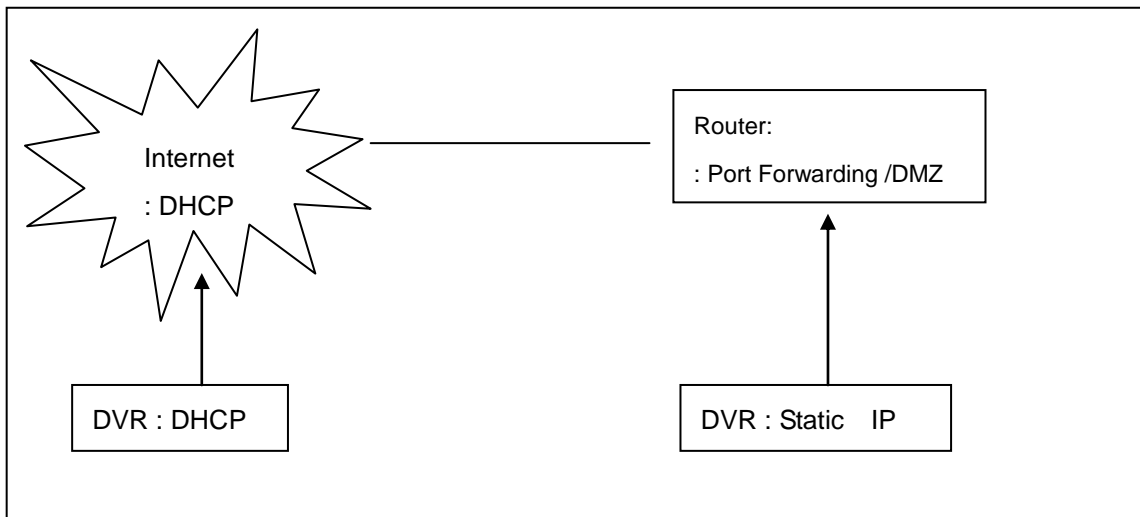

<Note> Each Router has different port forwarding settings. Please refer to the router manual or contact to your router manufacture for assistance.

7. DEVICE

7.1. GENERAL

This DVR support 1 Audio, Alarm input and 1 relay output1 and support HDMI out put.



1. The menus are displayed with options on the left-hand column and settings in the right hand column. A cursor (highlighted menu) can be moved using the Direction buttons [▲▼◀▶].

1) DISPLAY : Please decide to Output resolution

- It automatically detects and set correct video resolution on the monitor in default.

[800*600 → 1024*768 → 1280*720 → 1280*1024

→ 1600*1200 → 1680*1050 → 1920*1080]

- **HDMI AUTO** : Automatically detects and sets the HDMI resolution on the monitor connected to the DVR. It might display “no video” if a VGA monitor is not able to support high resolution.

<NOTE>

In order to connect HDMI and VGA output to use both monitors, please set up as the lowest resolution without selecting HDMI AUTO.

2) Audio Map: Select audio recording device usage 1~4.

The audio data is always recorded in real time unlike the video data that can be recorded in various modes including real time. There may be a slight delay in synchronization of the audio to video

3) Keypad Model: Select Joystick Controller and Baud Rate.

4) PTZ Event : DURATON [OFF,1SEC ~ 5 SEC] : Select PTZ EVENT duration.

5) Alarm out : DURATON [OFF,1SEC ~ 5 SEC] : Select Alarm duration.

6) Extend Device : Future use.

2. Save changes and exit the menu, press [MENU] button.

Exit the menu without making changes, press [CANCEL] button.

7.2. ALARM

This DVR support 4 Alarm inputs and 1 relay output. One Alarm input can be configured to one relay output. One relay output can be assigned to multiple alarm inputs.



1. Use Left/Right buttons [◀▶] to select on TAP menu “ALARM” The menus are displayed with options on the left-hand column and settings in the right hand column. A cursor (highlighted menu) can be moved using the Direction buttons [▲▼▶◀].
2. **INPUT:** Change the input type. Use [-, +] button to change the values.
3. **OUTPUT:** you can configure how the relay outputs are controlled: automatic or manual.
 - 1) **Use:** Change the output type.
 - 2) **Inactive:** Select turn off method of Relay out.
 - a. **Event (Automatic):** Relay out is turned off when the event expires. This setting is configured globally.
 - b. **Manual:** Relay out is turned off from this menu <Control>.
 - 3) Event Edit 
 - Press [enter] to edit multiple event. The menus are displayed with options on the left-hand column and settings in the right hand column. A cursor (highlighted menu) can be moved using the Direction buttons [▲▼▶◀] on IR remote.



-
- Change below options using [DEC/INC] buttons on IR remote or Clicking by mouse.
 - System menu contains below

- HDD Disk Fail
- Record System Fail
- Temperature warning.
- Fan Lock Warning
- Voltage Warning
- Low RTC Battery Warning
- External Device Event
- Network Link Disconnected
- Admin Login
- Power Recovery
- Disk Full
- Invalid password in sequence
- Auxiliary Event (Reserved)

4) Control: Manual stops for relay output and buzzer.

4. Buzzer

1) USE

- **ON:** The buzzer Sounds if an alarm is triggered. The buzzer will sound for the duration of the RECORD TIME. This buzzer related with Alarm Out. Please configure Alarm Out "ON" for Alarm buzzer.
- **OFF:** Disables the ALARM BUZZER function.

2) **Inactive:** Select turn off Buzzer

- a. Event (Automatic):** Buzzer is turned off when the event time expire.
- b. Manual:** Buzzer is turned off from this menu <Control>.

5. Save changes and exit the menu, press [MENU] button.

Exit the menu without making changes, press [CANCEL] button.

7.3. PTZ EVENT

When such as alarm trigger, motion detected or video loss occurs, this DVR sends preset command to PTZ camera. PTZ option must be enable and a protocol must be assigned to the camera channel.



1. Channel: Select desired PTZ camera.
2. Active: configure PTZ action [**NONE** → **GOTO** → **TOUR**] and Preset number or Tour group when event detected.
3. Inactive: Select Camera position after event duration expires.
4. Event Edit. 

Press [enter] to edit multiple event. The menus are displayed with options on the left-hand column and settings in the right hand column. A cursor (highlighted menu) can be moved using the Direction buttons [▲▼▶◀] on IR remote .



<Note> Do not set up Motion detection on PTZ camera for PTZ event. The signal will be looping

- 5 . Save changes and exit the menu, press [MENU] button.
Exit the menu without making changes, press [CANCEL] button.

8. SYSTEM

8.1. GENERAL

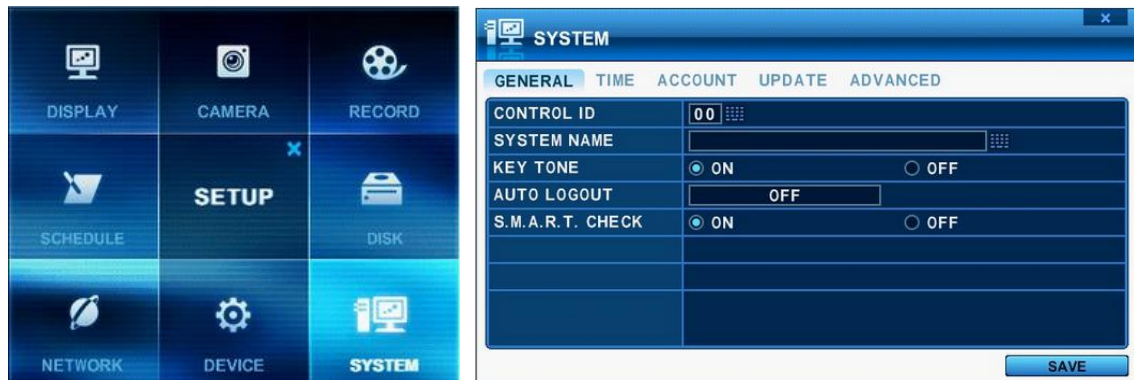

1. **CONTROL ID** : It is needed when controlling DVR in keypad.
2. **SYSTEM Name** : Type the DVR name to distinguish location when you have several DVRs on Network.
3. **KEY TONE** : By default, the DVR emits a beep every time a button is pressed. Set the key tone to off to turn button beep off. Default by "ON"
4. **AUTO LOGOUT** : You can configure the DVR to automatically log out users. Default by "OFF".
[OFF → 1 Minute → **3 Minute** → 5 Minute → 10 Minute]
5. **S.M.A.R.T. CHEK** : Turn ON or OFF to display HDD information in SMART STATUS tab of DISK menu.

8.2. TIME

Make sure to set up your Date and Time prior to start Recording.



1. Use Left/Right buttons [◀▶] to select on TAP menu “Time”. The menus are displayed with options on the left-hand column and settings in the right hand column. A cursor (highlighted menu) can be moved using the Direction buttons [▲▼◀▶]. Press [-, +] button to change the values.

- 1) **Time Zone** : Refer to <Appendix 1: Time Zone Chart>

Selects the time zone in which the DVR is located. Time Zone contains DST (Daylight Saving Time) On. If you choose Time Zone with DST, there is no change in the system time stamp for recorded data. When the Daylight saving End date and time occur, the DVR's time goes back one hour.

- 2) **Date Format:** Select Date display format.

[MM/DD/YYYY → DD/MM/YYYY → YYYY/MM/DD]

- 3) **NTP SYNC:** The internal time of DVR can be synchronized with an external time source using NTP (Network Time Server) Configuration. If the NTP option is ON, the DATE and Time option is inactivated.

- 4) **NTP Server:** Allow you to use a public or private NTP server. Enter the IP address of sever or domain. The default setting is public “pool.ntp.org”.

<Note> Time Sync. Interval : Min 64 sec. Max 1024 sec.

- 5) **NTP TEST** : Test whether NTP Server works or fail.

- 6) **Date & Time** : Set current time and date.

2.. Save changes and exit the menu, press [MENU] button.

Exit the menu without making changes, press [CANCEL] button.

8.3. ACCOUNT



1. Use Left/Right buttons [◀▶] to select on TAP menu “Account”. The menus are displayed with options on the left-hand column and settings in the right hand column. A cursor (highlighted menu) can be moved using the Direction buttons [▲▼◀▶]. Press [-, +] button to change the values.
 - 1) User/Name: DVR comes preconfigured with ADMIN. Select User 1~5, and then activate it by on.
 - a. Name Length: up to 10 characters.
 - b. Characters: A to Z, numerals 0 to 9.
 - 2) Activate : Select ON or OFF for user
 - 3) Privilege: Admin can define each user’s Privilege such as [PLAYBACK, PTZ CONTROL, BACKUP, CONFIGURATION (except for Disk and System), RECORD STOP, and SYSTEM SHUTDOWN]



- 4) Network PWD: DVR comes preconfigured with System password to Network access for Admin and Deny for User. It is possible to create different password for Network access choose by [Custom P/W].
 - a. Password Length: up to 14characters.
 - b. Characters: A to Z, numerals 0 to 9.

4) Usable Channel

Allow each user for different live monitoring.

5) System Password

Enter the 6 numbers for the new password, and then re-enter the same password under COMFIRM section. The asterisk is displayed for each character entered.

2. Save changes and exit the menu, press [MENU] button.

Exit the menu without making changes, press [CANCEL] button.

8.4. UPDATE



1. Download the latest firmware file and copy to USB Flash memory stick in the **Root** directory.

<NOTE >: Please make sure if you download all of files below (15M).

2. Connect or insert into Front USB. (If you are under recording, please stop the recording)

3. Using direction button to move [Start] button. Press **[+]** button to find upgrade file. If the DVR find a valid update file, update menu is activated.

4. Press **[-, +]** button to find proper upgrade file, Version information is displayed. If there are several valid update files, please check the display for changing.



5. Using direction button to move [Start] button then press **[+]** button to start update While it's updating, "in progress" message is displayed.

6. After the update process is complete, "Success" message is displayed. Press **[+]** button to restart. The DVR issues a single beep, if Micom update included.

NOTE1: Do not switch OFF or PRESS any key during the update process.

NOTE2. Please consult with your installer or seller before update DVR.

8.5 ADVANCED

ADVANCED contains brief system setting, FACTORY DEFAULT to reset setting as initial except IP setup, LANGUAGE, VIDEO MODE and VIDEO FORMAT weither **SD for Anaglogue** and **AHD for 720P** as each 2 Channels.

SYSTEM				
GENERAL TIME ACCOUNT UPDATE ADVANCED				
FACTORY DEFAULT	<input type="radio"/> ON		<input checked="" type="radio"/> OFF	
LANGUAGE	ENGLISH			
VIDEO MODE	NTSC			
VIDEO FORMAT	1, 2 CH	AHD	3, 4 CH	AHD
	5, 6 CH	AHD	7, 8 CH	AHD
	9, 10 CH	AHD	11, 12 CH	AHD
	13, 14 CH	AHD	15, 16 CH	AHD
	SAVE			

<NOTE > : Please make sure if you connect correct video format of camera to each 2 channels those you set on VIDEO FORMAT.

If you meet "Please check video format. (SYSTEM > ADVANCE) CH (OO, OO, OO, OO)", set correct video format again between AHD and SD on ADVANCE, SYSTEM in SETUP.

8.6. INFO

Press [info] button on IR remote or select icon on the menu. The system information is displayed.



The screenshot shows the 'INFO' window with three tabs: SUMMARY, DISK, and NETWORK. The SUMMARY tab is active, displaying a table of system information and a QR code.

MODEL BRIEF	H.264 AHD Entry 16Ch
HOSTNAME	GR53EE3D
MAC	00:23:63:53:EE:3D
LANGUAGE	ENGLISH
NETWORK	192.168.4.102:7000
RECORD DISK	250G
DISK SUMMARY	1 STREAM
VERSION	EB2010-R4701



1) SUMMARY : It contains brief model information, Mac Address and installed HDD status



The screenshot shows the 'DISK' tab selected in the 'INFO' window. It displays a table with columns for disk order and partitions A/J.

DISK ORDER	A / F	B / G	C / H	D / I	E / J
INTERNAL SATA	250G				
FRONT USB	4.14G				
REAR USB					



The screenshot shows the 'NETWORK' tab selected in the 'INFO' window. It displays a table with columns for network number, IP address, user, and service.

NO.	IP ADDRESS	USER	SERVICE
1	192.168.4.101	admin	CAPTURE

2) DISK : It contains all DISK information including USB memory.

3) NETWORK : It shows IP address , USER and service of NET user.

VII. PAN/TILT ZOOM CONTROL

PTZ control is available for supported third-party dome cameras. The PTZ option must be configured for each camera channel. For PTZ setup, refer to Camera Menu> **PTZ setup**.





The layout of the PTZ interface conforms to the layout of the front of the DVR or the remote controller. Menu button is the guide anchor position for all other buttons. When in PTZ interface mode, all buttons used for the PTZ related operation.

1. P.T.Z. Menu

- 1) To activate the Pan/Tilt Control, select the full screen display of the camera you wish to control.
- 2) Then press the **[P/T/Z/FOCUS]** button. Shortcut Menu box pops up, as shown below.



<Note > Please Refer to **Help Menu** for specific control.

INDICATOR	ACTIONS
 [ENTER] [CANCEL]	<ul style="list-style-type: none"> • Press this button to display “HELP” Menu. Press [ENTER] Button again, or [CANCEL] button to cancel Help Menu. <div style="text-align: center;">  </div> <ul style="list-style-type: none"> • Press this button to cancel “PAN/TITL” Operation.
 [MENU] Button	<ul style="list-style-type: none"> • PTZ camera control interface will be extended to use whole function. Press this button again to make short-cut menu.
	<ul style="list-style-type: none"> • To Tilt up and Down. • To pan Right and Left.
	<ul style="list-style-type: none"> • Zooming In and Out.

1.1 How to control PTZ by mouse

User can control PTZ camera by mouse controller.

It follows mouse cursor instead of using direction button to move.

- 1) Press PTZ button on the virtual remote controller.
- 2) PTZ menu and control box is displayed like below picture.
- 3) Place the mouse cursor inside of rectangle boundary and move the mouse cursor while pressing left mouse button to the direction you want.

Note. Mouse cursor cannot get out of this rectangle while pressing left mouse button.





- 4) Press  menu button to have the virtual PTZ controller. Zoom in/out, Go to, Tour and other function can be controlled by using the virtual PTZ controller.

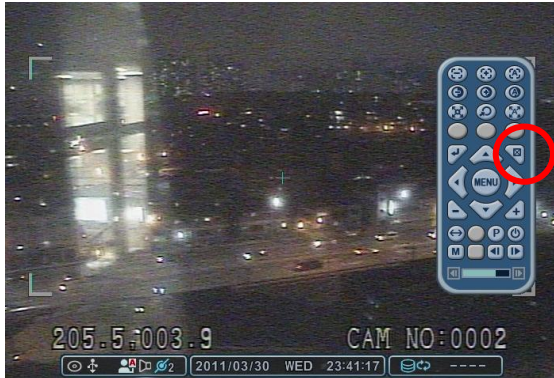

- 5) To escape from PTZ mode, press ESC button on PTZ controller. Or click (right button) the outside of control box to have the virtual remote controller. Then click ESC button.



2. Preset & Tour

Button	Function
	<p>Set preset position; SPOT OUT on remote controller</p> <p>Move the PTZ into desired location.</p> <p>Press the Preset button.</p> <p>Custom 1 will illuminate.</p> <p>Set the # for the Preset location.</p> <p>Press Enter to save and exit.</p>
	<p>Go to preset position; INFO on remote controller</p> <p>Press Go to button.</p> <p>Enter the desired Preset # and press Enter.</p>
	<p>Start Auto Tour; BACKUP on remote controller</p> <p>Press Auto Tour Button.</p> <p>Press the + button and enter the range of Preset and press Enter.</p>

2.1 Tour Group

A preset Tour Group allows a camera to move through a programmed sequence of PTZ presets.



1) Communication settings.

: Configure appropriate model and then enter the corresponding baud rate, PTZ ID(address). Please refer to the PTZ manufacturer's instruction manual for proper jumper settings to match the protocols to the DVR.

2) **Tour:** There are 4 programmable Tours. Using the [-, +] button to change the values [Group 1 → Group 2 → Group 3 → Group 4]

3) This is sub menu of each Tour group. The menus are displayed with options on the left-hand column and settings in the right hand column.

a. **Group List:** Each Tour Group consists of up to 10 preset position.



b. **Preset no. :** Enter the start preset no and stop preset.

c. **Dwell Time:** Set the pause between end of current preset and the start of the next preset.



d. **Change:** Add, modify or clear the Tour list using this option.

f. Repeat the procedure in **step b** to **d** to add Tour list.

3. Custom Functions

Button	Function
	PTZ custom function 1; DISPLAY on remote controller
	PTZ custom function 2; ZOOM on remote controller
	PTZ custom function 3; P/T/Z on remote controller

4.Auto Pan / Auto Tilt / Power

Button	Function
	Auto Pan; STOP on remote controller
	Auto Tilt; REW on remote controller
	Power on / off; FF on remote controller

6 . PTZ Camera Model – PAN/TILT/ZOOM Camera List

#	Model Name	3X	Speed	Preset	Go to	Tour	A. Pan	A.Tilt	Pat	Me	Esc/ Enter
1	PELCO, D	o	o	o	o	o	o		o	o	
2	RVT, EZ Protocol	o	o	o	o	o			o	o	o
3	PELCO, P	o	o	o	o	o	o		o	o	
4	Hitron, Fastrax 2	o	o	o	o	o			o	o	o
5	Bosch, Auto Dome										
6	MERIT LINLIN										
7	APPROMEDIA										
8	LG,MULTIXE CAM/DOME										
9	BBV,PROTOCOL V2										

<Note> Speed has 0~8 steps

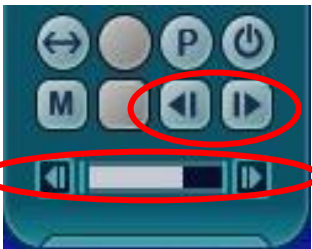

1 (Slow) – 8 (Fast)

VIII.PLAYBACK /SEARCH

The DVR supports 2 playback mode; playback and Search. The DVR offers a variety of search functions that enables you to quickly and efficiently locate and review a specific period from the database. It supports three different search modes: Date/Time, Event, Event Area , and Log search.

1. Playback

When the [PLAY] button is pressed, the DVR starts to play back any recorded data from the latest data, whether in live or recording mode. When the DVR reaches the end of the recorded data, it will stop the playback.

During the playback, the DVR may be played back in reverse, paused, speed search up to 16 times the normal speed, or move picture by picture.

2. Time Search

2.1 Multi Channel Playback

1. Press the  **[Time Search]** button to access the time search table.
Calendar will be displayed in left and hour,minute and second search will in right.
The data are color-coded by category: EVENT(Red) > Normal (Yellow)

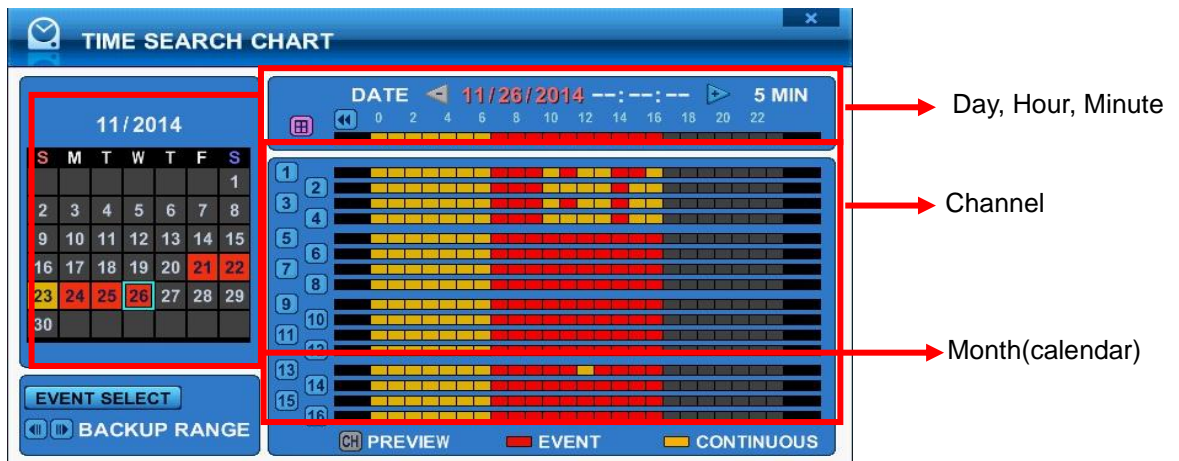

2. Select date in calendar and use **[+]** button to navigate to the desired **Hour→Minute (5MIN) →Second (30SEC)**. Use **[-]** button to go back **Second(30SEC) →Minute(5min) →Hour**.
Using mouse, wheel is used for **[+/-]** button.
<note> Use **[Play]** button to move at the end of data
Use **[Rewind]** or **[Fast-forward]** button to move next page.
3. To review all channels, press **[ENTER]** button at the slot from the bar. Using mouse, double click.
4. The DVR will start the playback mode, displaying all 16 channels. Any channel number or the DISPLAY button may be pressed to change the display mode.

2.2 Preview Search (Single Channel Playback)

The DVR allows you to quickly review a single channel of playback over a period of Day, Hour, and Minute.

1. Press the  **[Time Search]** button to access the time search table. Calendar will be displayed in left and hour, minute and second search will in right.

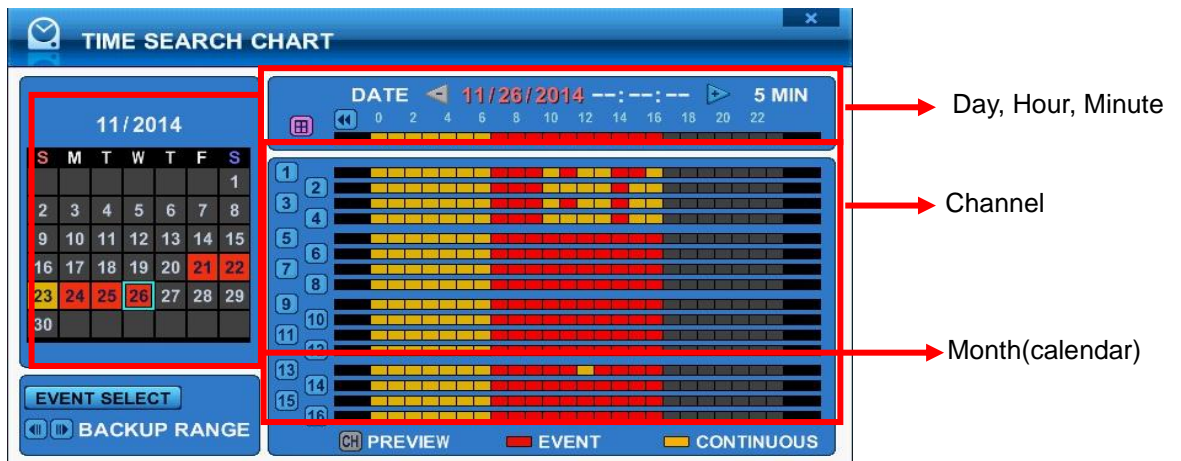

1. Choose the desired channel to review pressing by numeric button.



2. Use **[+]** button to navigate to the desired **Day→Hour→Minute (5min) →Minute (1min)**. Use **[-]** button to go back Minute (1min) →Minute (5min) →Hour→Day. Using mouse, wheel is used for **[+/-]** button.
3. While it's reviewing snapshot, use numeric buttons to review other channel.
4. Use the directional button to select snapshot and, press **[ENTER]** button. Using mouse, double click.
5. The DVR will start the playback mode, displaying selected channel. Any channel number or the DISPLAY button may be pressed to change the display mode.

2.3 Event Record Search

Event Record search feature allows you to search for recorded video by event. The time search table displays time events. As a default, TIME SEARCH CHART displays CONTINUOUS recording (Yellow) and EVENT recording (Red). TIME SEARCH CHART will display the different outcome according to the SEARCH MODE below.

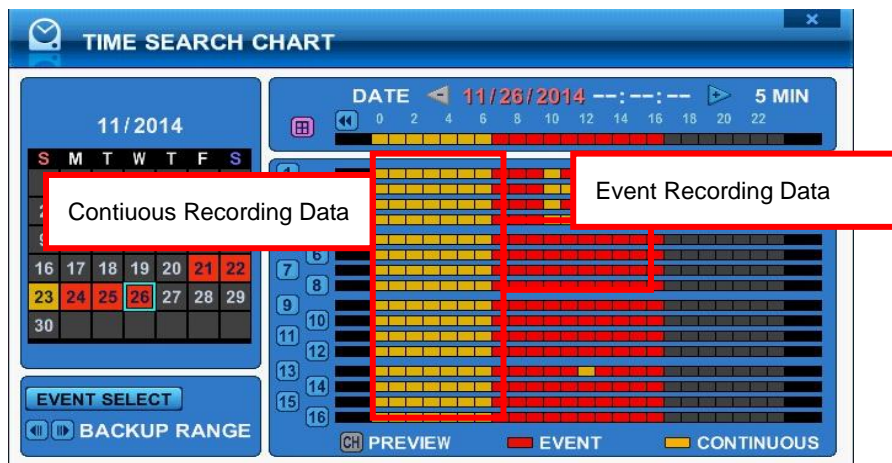

1. Press "Event Select" button to change search mode.

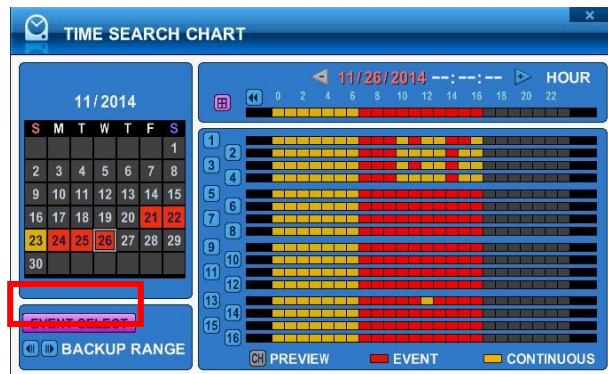

2. Press [Enter] to set up. Press [+/-] button to select "event record". It's set by default.



- Press [+/-] button to select "SEARCH MODE " (Event source /Motion Area).
By selecting Search Mode, TIME SEARCH CHART will display the different outcome.

<Note> : EVENT RECORD is set by default and it makes TIME SEARCH CHART display EVENT recording in Red as above FIGURE 1.

2.4 Event Source Search

Event source search feature allows you to search the recording data in events of ALRAM, MOTION and VLOSS triggered on DVR previously.

- Press [+/-] button to select "event source" in search mode.
And select event source (Alarm,Motion,Vloss) which you want to search.



- ALARAM : Select alarm input 1~16.
- MOTION : Select the channel 1~16.
- VLOSS (Video loss) : Select the channel 1~16.
- SYSTEM : Inactivated

- User can have multiple selections by pressing  icon as below.



Example)

1. If you select MOTION 1 and press MENU button on the remote controller, TIME SEARCH CHART will display the recording data in red at the time of motion triggered on channel #1. The other recording data will turn in yellow. So users can easily search the recording data and playback to see what happened when motion was triggered on channel #1.

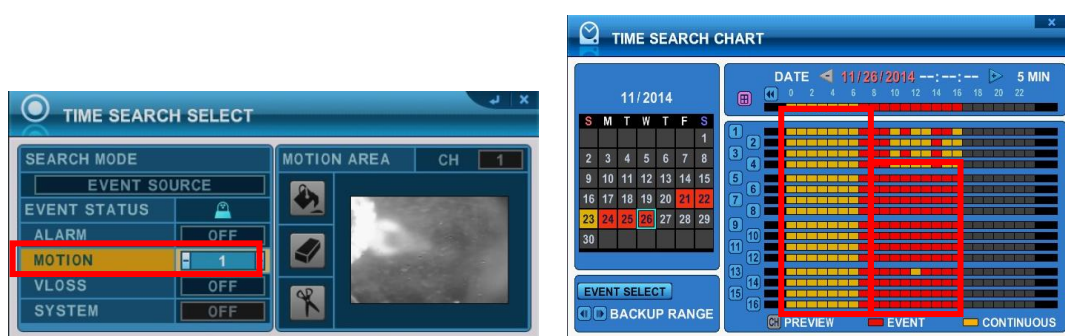

2. If you select ALARM 1 and press MENU button on the remote controller, TIME SEARCH CHART will display the recording data in red at the time of alarm 1 input triggered. The other recording data will turn in yellow. So users can easily search the recording data and playback to see what happened when alarm 1 was triggered.

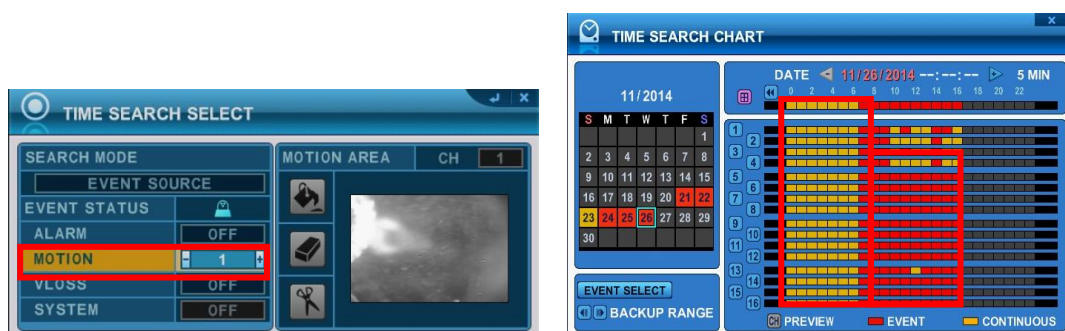



2.5 Motion Area Search (Single Channel Playback)

The DVR searches for recorded video that matches the search area defined by selected cell.

1. Select "MOTION AREA" (Single channel playback) to search the recording data that has motion in a specific area in a certain channel.



2. By pressing [+/-] button, select the channel you want to search.
3. Select motion area you want to search.
 -  : Select All. Press [Enter] to select.
 -  : Clear All. Press [Enter] to select.
 -  : Select specific. Press [Enter] to select.

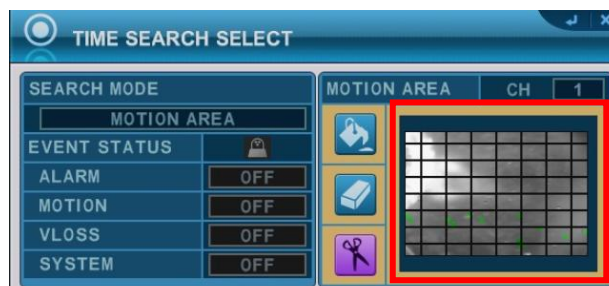

4. Press MENU button, then TIME SEARCH CHART will display the recording data in red to see what happened in that channel.

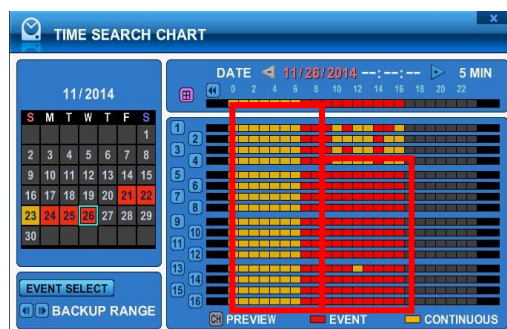

3.Go to Search

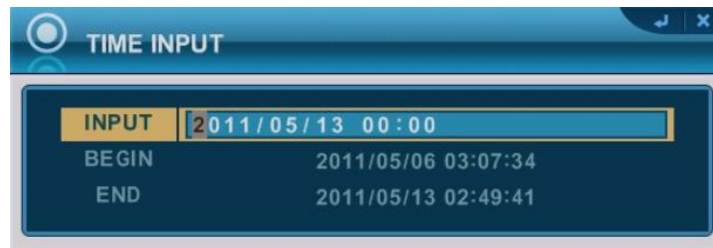

1. Press [Time Search] button for 2 seconds. Then [Time Input] menu will pop up.
2. Set the date and time you wish to search.
3. Press [enter] or Menu to start search.

4.Log List Search

The logs can be used to search and review directly to a point in time of the recorded data. Alarm, motion, video loss and system related logs can be searched and played back directly from the time of the incident.

1. To start Event Search, press  [Log] button on IR Remote, then Log List Menu pops up, as shown below.

A screenshot of a software interface titled "LOG". It has a menu bar with options: "ALL", "SYSTEM", "NETWORK", "EVENT", and "VLOSS". Below the menu bar is a table with columns: "DATE", "TIME", "MESSAGE", and "PAGE-1". The table contains 12 rows of event data.

DATE	TIME	MESSAGE	PAGE-1
11/26/2014	16:10:41	EVENT CH 7 (MOTION CH 7)	
11/26/2014	16:10:39	SNAPSHOT (192.168.4.101 ADMIN)	
11/26/2014	16:10:30	EVENT CH 16 (MOTION CH 16)	
11/26/2014	16:10:30	EVENT CH 14 (MOTION CH 14)	
11/26/2014	16:10:30	EVENT CH 9 (MOTION CH 9)	
11/26/2014	16:10:30	EVENT CH 11 (MOTION CH 11)	
11/26/2014	16:10:29	EVENT CH 5 (MOTION CH 5)	
11/26/2014	16:10:25	EVENT CH 15 (MOTION CH 15)	
11/26/2014	16:10:13	EVENT CH 16 (MOTION CH 16)	
11/26/2014	16:10:13	EVENT CH 14 (MOTION CH 14)	
11/26/2014	16:10:13	EVENT CH 9 (MOTION CH 9)	
11/26/2014	16:10:12	EVENT CH 11 (MOTION CH 11)	

MENU TAP	CONDITION
ALL	• It has a list of all the events since the initial power on procedure of DVR
SYSTEM	• It shows All System List.
NETWORK	• It shows NETWORK List.
EVENT	• It shows All Event except for Alarm, Motion, Video Loss and System.
VIDEO LOSS	• It shows Video Loss List.

2. Use Up/Down buttons [▼▲] to desired "Time" to playback. Use Left/Right buttons [◀▶] to move NEXT page.
3. Press [ENTER] button to start playback.

<Note> Log list is saved on HDD.

 icon means that there is more information in detail.

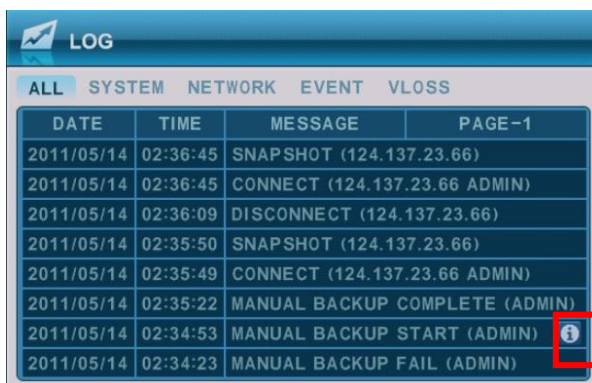

LOG			
ALL SYSTEM NETWORK EVENT VLOSS			
DATE	TIME	MESSAGE	PAGE-1
2011/05/14	02:36:45	SNAPSHOT (124.137.23.66)	
2011/05/14	02:36:45	CONNECT (124.137.23.66 ADMIN)	
2011/05/14	02:36:09	DISCONNECT (124.137.23.66)	
2011/05/14	02:35:50	SNAPSHOT (124.137.23.66)	
2011/05/14	02:35:49	CONNECT (124.137.23.66 ADMIN)	
2011/05/14	02:35:22	MANUAL BACKUP COMPLETE (ADMIN)	
2011/05/14	02:34:53	MANUAL BACKUP START (ADMIN)	
2011/05/14	02:34:23	MANUAL BACKUP FAIL (ADMIN)	

-Press 'info' button.

The window of detail information will be popped up like below picture.



LOG INFO	
TIME	2011/05/14 02:34:53
MESSAGE	MANUAL BACKUP START
RANGE	2011/05/07 01:00:00 ~ 2011/05/07 01:05:00
USER	ADMIN
CHANNEL	16

2011/05/14	02:34:53	MANUAL BACKUP START (ADMIN)	
2011/05/14	02:34:23	MANUAL BACKUP FAIL (ADMIN)	

IX.BACKUP

1. Manual Back up

1.1. External USB HDD / Memory Stick

1. Insert a USB device into the USB connection port on the front or rear panel

<Note> Make sure your USB device has enough space before commencing backups.

2. Press [BACKUP] button to display the backup menu.

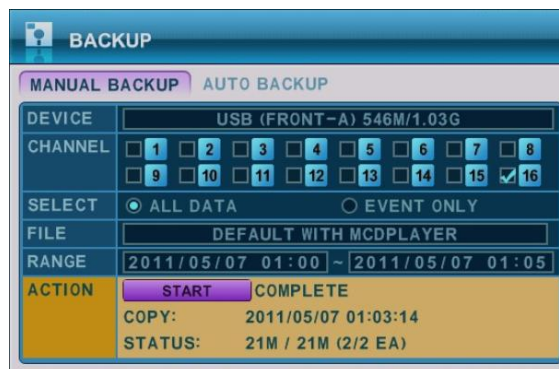

3. Use [-, +] button to change device selection : USB (Front or Rear)
4. Use the [-, +] button to select a channel. All channels are set by default.
5. Please select the data for BACKUP.
 - (1) ALL Data: Normal Recording Data
 - (2) Event Only: Event Recording Data.
6. File format when saving is “.s”.
7. Select the time range starting time and ending time.
8. Enter the numbers as required in 24-hour format, then move to **START**.
9. Press the **[+]** button to start BACKUP.

* USB icon will be highlighted in blue during the backup.

• If there is not enough space on your USB memory stick, the system will not proceed with backup.



USB Memory Stick

- The backup progress indicator will be displayed at the bottom of the window.
 - To backup as an AVI File, set the file format to AVI using the [+] button in FILE.
10. After backup process is finished, USB icon will be highlighted in white.

1.2. External CD/DVD –RW Backup

External CD/DVD-RW is recognized within 10 seconds after plug in UBS connection cable to UBS port in DVR.

1. Plug in USB connector into the USB connection port on the front or rear panel.
2. Press [BACKUP] button to display the backup menu.

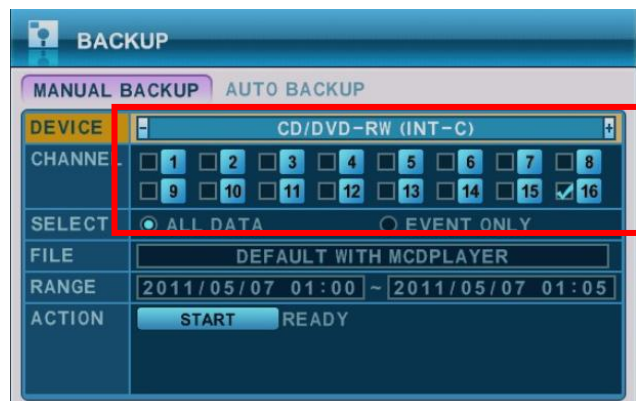

The external CD/DVD-RW procedure is the same as using the USB device for backup.

- when it's full and resume the process once new media is inserted into the drive.

* The Playback software will simply “**auto-run**” and does not require any software installation on your PC.

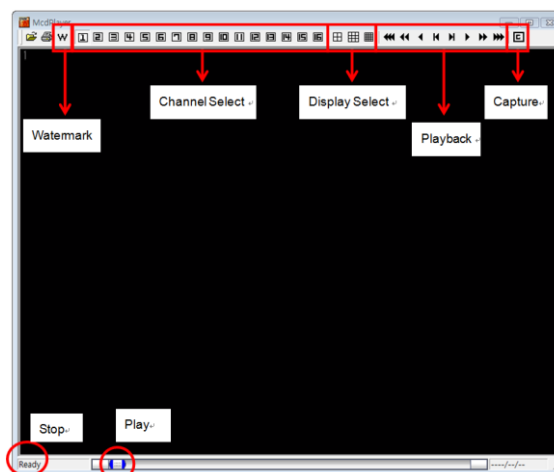

<Note> Please Refer to [LOCAL PLAYER] section to read about back-up devices.

<Note 2> When you back up as Multi-Section the Play List pops up instead of Auto Run.

SERIAL	BACKUP TIME	CLIP TIME
W180288	2006/07/01 15:57:02	2006/06/30 18:25:00
W180288	2006/07/01 16:00:09	2006/06/30 19:00:00
W180288	2006/07/01 16:01:57	2006/06/30 19:05:00

1.3 Back up Range Setup

Press [**◀**] button to set backup Start time , press [**▶**] button to set End. Selected time will be changed [**Violet**] Color.

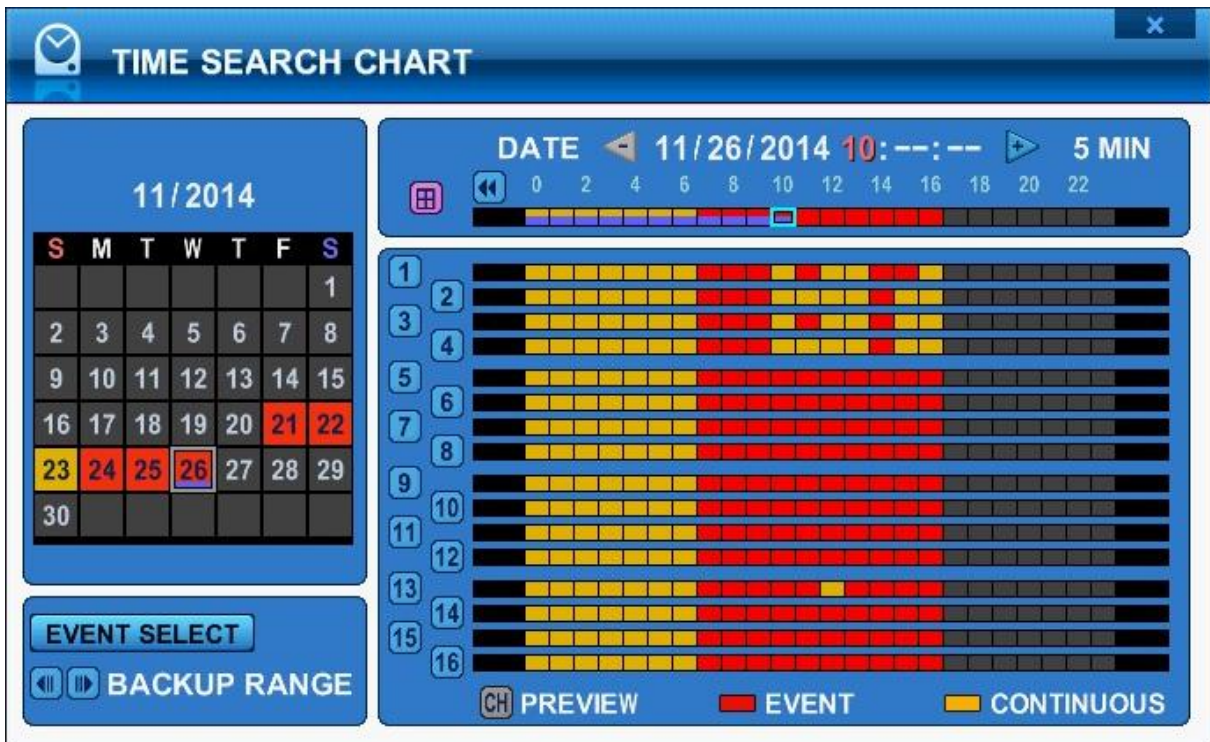

Selected backup time from 19:00~59 will be displayed on Backup range.

[LOG IN/OUT] button is toggled for the range.

2. Auto Back up(FTP)

1. Use [-, +] button to change select device: FTP

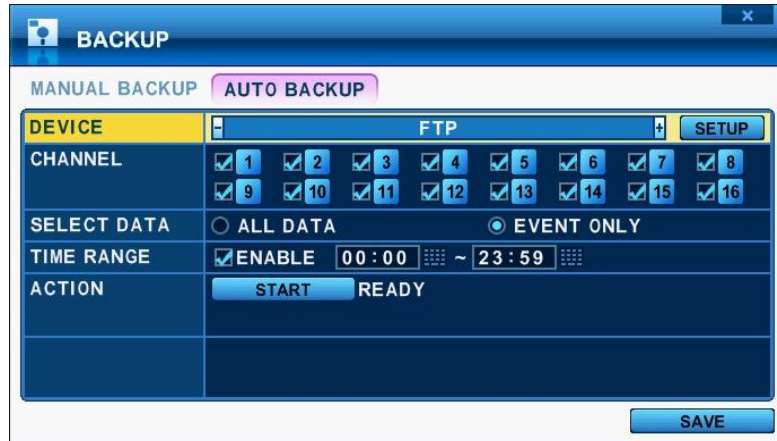

2. Use direction button to move FTP setup. The menus are displayed with options on the left-hand column and settings in the right hand column.



ITEM	ADJUSTMENT
Server	<ul style="list-style-type: none"> Select Highlight FTP Server and then press numeric buttons to define an FTP server.
Port	<ul style="list-style-type: none"> Define the port that the FTP server will communicate through.
User ID	<ul style="list-style-type: none"> Enter the user ID of FTP Server. (It is recognized as a small letter, even it's displayed as a Capital Letter)
Password	<ul style="list-style-type: none"> Enter the password. (It is recognized as a small letter, we do not support capital Letter)
Connection	<ul style="list-style-type: none"> Select PASSIVE mode or REGULAR Mode.
BACKUP PATH	<ul style="list-style-type: none"> The path should be made in FTP server in advance. Mac address is set with the default in consideration of the situation that lots of DVRs may backup its file to the one FTP server.

X.SPECIFICATION

Specifications		4CH	8CH	16CH
Video Input		4ch BNC	8ch BNC	16ch BNC
Video Output		HDMI(1920*1080i), VGA(1920*1080i)		
Compression		H.264		
Alarm In/Out(Relay)		4/1		
Operating System		EMBEDDED LINUX		
System Control		IR Remote Controller, Mouse		
Live Display Speed		Real Time Display		
Maximum Recording Speed	NTSC	60fps 1280X720	120fps 1280X720	240fps 1280X720
		120fps 960X480	240fps 960X480	480fps 960X480
		120fps 720X480	240fps 720X480	480fps 720X480
		120fps 720X240	240fps 720X240	480fps 720X240
		120fps 360x240	240fps 360x240	480fps 360x240
	PAL	50fps 1280X720	100fps 1280X720	200fps 1280X720
		100fps 960x576	200fps 960x576	400fps 960x576
		100fps 720x576	200fps 720x576	400fps 720x576
		100fps 720x288	200fps 720x288	400fps 720x288
		100fps 360x288	200fps 360x288	400fps 360x288
Audio In/Out		4/1		
Features				
Display		Brightness, Contrast, Color Adjustment Per Channel		
Recording Mode		Manual, Schedule, Alarm, Motion		
		Resolution & Picture quality Adjustment per channel, Privacy Mask supported		
Alarm Recording		Pre-Alarm: 5sec ~ 300sec / Post-Alarm: 5sec. ~300 sec.		
Motion Detection		8*8 Grids per Channel		

Search Mode	Date & Time, Camera , Alarm / Motion / Video loss, Motion area	
Playback Modes	Forward & Reverse: Pause, Frame by Frame, Normal Speed, 2X, 4X, 8X, 16X	
Multi-tasking	Simultaneous Live Display, Playback, Record/Back-up, Remote Transmission	
Watchdog	Power Failure Recovery: Auto Reboot with Maintaining Previous Record Settings	
Watermark	Provided	
Back Up	USB Flash Memory Stick, External HDD, External CD/DVD-RW, Client S/W, Webserver	
Interface	RS485, Ethernet(10/100 Base-T), USB 2.0	
	RS485	
HDD	Internal	1 Internal SATA port
	External	1 e-SATA port
Power	12V 2A	
Network	LAN, WAN, Internet (MAX 10 users)	
Remote	Central Monitoring Client Software PC Client Software for Windows, MAC, Linux Web Client Software (Internet Explorer) Smart Phone Apps (for iPhone, Android, BlackBerry and Windows Mobile)	
Operation Environment	30 ~ 80% RH, 5°C~40°C(41°F ~ 104°F)	
Dimension / Weight	300 X 227 X 50 (Cm) / 1.4Kg	

Appendix 1. : Time Zone Chart

Standard Time	Time Zone
GMT+00:00	Standard
	European DST
GMT+01:00	Standard
	European DST
	Namibian DST
GMT+02:00	Standard
	Zion DST
	European DST
	Lebanese DST
	Jordanian DST
	Russian DST
	Egyptian DST
GMT+03:00	Standard
	Russian DST
GMT+03:30	Iranian DST
GMT+04:00	Standard
	Azerbaijani DST
	Russian DST
GMT+04:30	Standard
GMT+05:00	Pakistan DST
	Russian DST
GMT+05:30	Standard
GMT+05:45	Standard
GMT+06:00	Standard
	Russian DST
GMT+06:30	Standard
GMT+07:00	Standard
	Russian DST
GMT+08:00	Standard
	Russian DST
GMT+09:00	Standard
	Russian DST
GMT+09:30	Standard
	Australian DST

GMT+10:00	Standard
	Russian DST
	Australian DST
GMT+11:00	Standard
	Russian DST
GMT+12:00	Standard
	New Zealandian DST
GMT+13:00	Standard
GMT-01:00	Standard
	European DST
GMT-02:00	Standard
GMT-03:00	Standard
	Brazilian DST
	European DST
GMT-04:00	Uruguayan DST
	Chilian DST
GMT-04:30	US DST
	Standard
GMT-05:00	Standard
	US DST
GMT-06:00	Standard
	Mexican DST
	US DST
GMT-07:00	Standard
	Mexican DST
	US DST
GMT-08:00	Standard
	Mexican DST
	US DST
GMT-09:00	Standard
	US DST
GMT-10:00	Standard
GMT-11:00	Standard

WEEE Symbol Information



Correct Disposal of This Product (Waste Electrical & Electronic Equipment)

(Applicable in the European Union and other European countries with separate collection systems)

This marking shown on the product or its literature, indicates, that it should not be disposed with other household wastes at the end of its working life. To prevent possible harm to the environment or human health from uncontrolled waste disposal, please separate this from other types of wastes and recycle it responsibly to promote the sustainable reuse of material resources.

Household users should contact either the retailer where they purchased this product, or their local government office, for details of where and how they can take this item for environmentally safe recycling.

Business users should contact their supplier and check the terms and conditions of the purchase contract. This product should not be mixed with other commercial wastes for disposal.

<Memo>